

Foreword

Congratulations on choosing a SUBARU vehicle. This Owner's Manual has all the information necessary to keep your SUBARU in excellent condition and to properly maintain the emission control system for minimizing emission pollutants. We urge you to read this manual carefully so that you may understand your vehicle and its operation. For information not found in this Owner's Manual, such as details concerning repairs or adjustments, please contact the dealer from whom you purchased your SUBARU or the nearest SUBARU dealer.

The information, specifications and illustrations found in this manual are those in effect at the time of printing. FUJI HEAVY INDUSTRIES LTD. reserves the right to change specifications and designs at any time without prior notice and without incurring any obligation to make the same or similar changes on vehicles previously sold. This Owner's Manual applies to all models and covers all equipment, including factory installed options. Some explanations, therefore may be for equipment not installed in your vehicle.

Please leave this manual in the vehicle at the time of resale. The next owner will need the information found herein.

FUJI HEAVY INDUSTRIES LTD., TOKYO, JAPAN

 **SUBARU** is a registered trademark of FUJI HEAVY INDUSTRIES LTD.

© copyright 2008 FUJI HEAVY INDUSTRIES LTD.

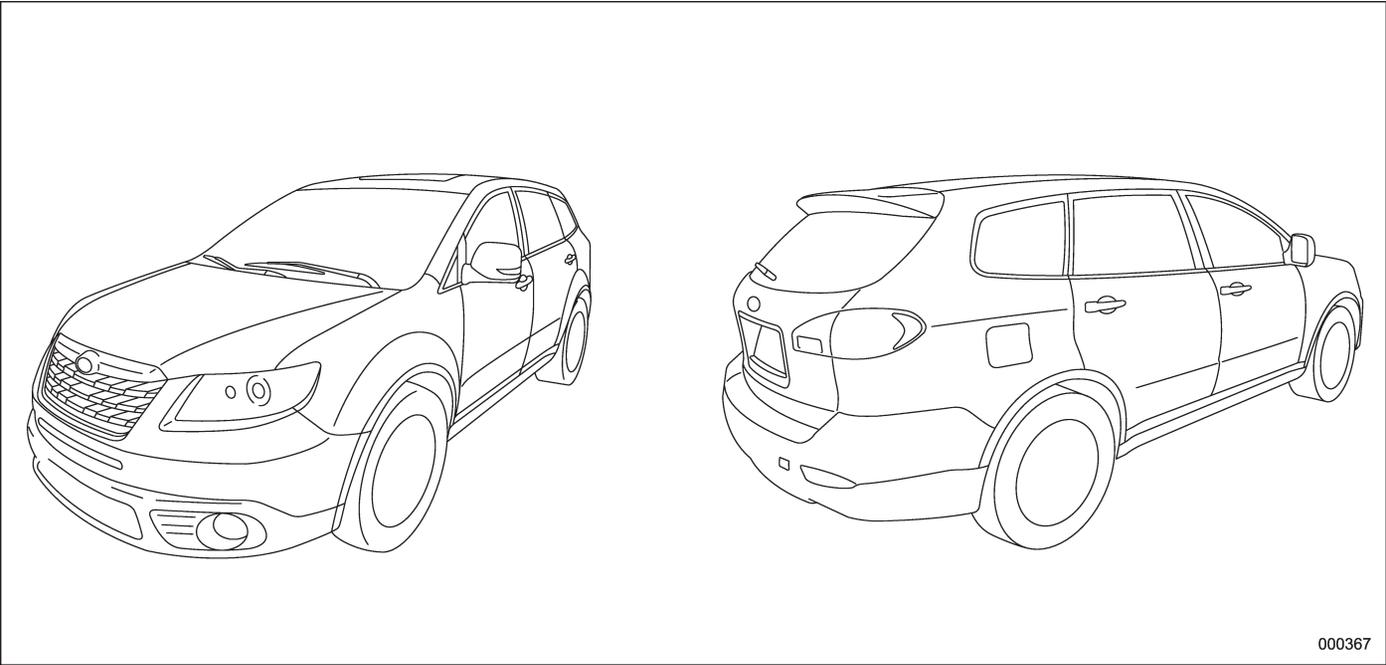

000367

Warranties

■ Warranties for U.S.A.

All SUBARU vehicles distributed by Subaru of America, Inc. and sold at retail by an authorized SUBARU dealer in the United States come with the following warranties:

- SUBARU Limited Warranty
- Emission Control Systems Warranty
- Emissions Performance Warranty

All warranty information, including details of coverage and exclusions, is in the "Warranty and Maintenance Booklet". Please read these warranties carefully.

■ Warranties for Canada

All SUBARU vehicles distributed by Subaru Canada, Inc. and sold at retail by an authorized SUBARU dealer in Canada come with the following warranties:

- SUBARU Limited Warranty
- Anti-Corrosion Warranty
- Emission Control Warranty

All warranty information, including details of coverage and exclusions, is in the "Warranty and Service Booklet". Please read these warranties carefully.

CAUTION

- **If your vehicle is equipped with a navigation system and/or Rear Seat Entertainment System, the displays contain mercury. Therefore, the displays of the navigation system and/or Rear Seat Entertainment System must be removed before vehicle disposal. Once the displays have been removed, please reuse, recycle or dispose of them as hazardous waste.**
- **If your vehicle is equipped with High Intensity Discharge (HID) headlights, the HID headlights contain mercury. Therefore, it is necessary to remove HID headlights before vehicle disposal. Once removed, please reuse, recycle or dispose of the HID headlights as hazardous waste.**

How to use this Owner's Manual

■ Using your Owner's Manual

Before you operate your vehicle, carefully read this manual. To protect yourself and extend the service life of your vehicle, follow the instructions in this manual. Failure to observe these instructions may result in serious injury and damage to your vehicle.

This manual is composed of fourteen chapters. Each chapter begins with a brief table of contents, so you can usually tell at a glance if that chapter contains the information you want.

Chapter 1: Seat, seatbelt and SRS airbags

This chapter informs you how to use the seat and seatbelt and contains precautions for the SRS airbags.

Chapter 2: Keys and doors

This chapter informs you how to operate the keys, locks and windows.

Chapter 3: Instruments and controls

This chapter informs you about the operation of instrument panel indicators and how to use the instruments and other switches.

– CONTINUED –

Chapter 4: Climate control

This chapter informs you how to operate the climate control.

Chapter 5: Audio

This chapter informs you how to operate your audio system.

Chapter 6: Interior equipment

This chapter informs you how to operate interior equipment.

Chapter 7: Starting and operating

This chapter informs you how to start and operate your SUBARU.

Chapter 8: Driving tips

This chapter informs you how to drive your SUBARU in various conditions and explains some safety tips on driving.

Chapter 9: In case of emergency

This chapter informs you what to do if you have a problem while driving, such as a flat tire or engine overheating.

Chapter 10: Appearance care

This chapter informs you how to keep your SUBARU looking good.

Chapter 11: Maintenance and service

This chapter informs you when you need to take your SUBARU to the dealer for scheduled maintenance and informs you how to keep your SUBARU running properly.

Chapter 12: Specifications

This chapter informs you about the dimensions and capacities of your SUBARU.

Chapter 13: Consumer information and Reporting safety defects

This chapter informs you about Tire information, Uniform tire quality grading standards and Reporting safety defects.

Chapter 14: Index

This is an alphabetical listing of all that's in this manual. You can use it to quickly find something you want to read.

■ Safety warnings

You will find a number of WARNINGS, CAUTIONS and NOTES in this manual.

These safety warnings alert you to potential hazards that could result in injury to you or others.

Please read these safety warnings as well as all other portions of this manual carefully in order to gain a better understanding of how to use your SUBARU vehicle safely.

**WARNING**

A WARNING indicates a situation in which serious injury or death could result if the warning is ignored.

**CAUTION**

A CAUTION indicates a situation in which injury or damage to your vehicle, or both, could result if the caution is ignored.

NOTE

A NOTE gives information or suggestions how to make better use of your vehicle.

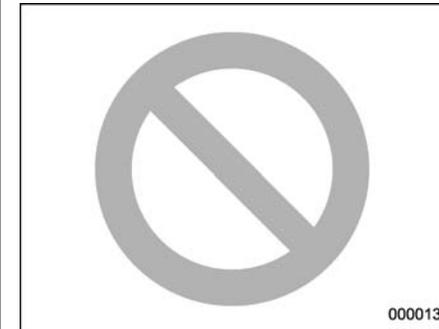
■ Safety symbol

000013

You will find a circle with a slash through it in this manual. This symbol means "Do not", "Do not do this", or "Do not let this happen", depending upon the context.

Vehicle symbols

There are some of the symbols you may see on your vehicle.

For warning and indicator lights, refer to “Warning and indicator lights” in the illustrated index section in this chapter.

Mark	Name
	WARNING
	CAUTION
	Passengers' windows lock
	Fuel
	Front fog lights
	Parking lights
	Hazard warning flasher
	Seat heater

Mark	Name
	Child restraint lower anchorages
	Child restraint top tether anchorages
	Horn
	Windshield wiper deicer
	Wiper intermittent
	Windshield wiper and washer
	Windshield wiper mist (for single wipe)
	Rear window wiper
	Rear window washer
	Lights
	Headlight beam leveler

Mark	Name
	Parking lights, tail lights, license plate lights and instrument panel illumination
	Headlights
	Turn signal
	Illumination brightness
	Engine hood
	Fan speed
	Instrument panel outlets
	Instrument panel outlets and foot outlets
	Foot outlets
	Windshield defroster and foot outlets
	Windshield defroster

– CONTINUED –

Mark	Name
	Rear window defogger/Outside mirror defogger
	Air recirculation
	Outside air
	Engine oil
	Washer
	Door lock (transmitter)
	Door unlock (transmitter)
	Rear gate (transmitter)
	Power folding mirror

Safety precautions when driving

■ Seatbelt and SRS airbag

WARNING

- All persons in the vehicle should fasten their seatbelts **BEFORE** the vehicle starts to move. Otherwise, the possibility of serious injury becomes greater in the event of a sudden stop or accident.
- To obtain maximum protection in the event of an accident, the driver and all passengers in the vehicle should always wear seatbelts when the vehicle is moving. The SRS (Supplemental Restraint System) airbag does not do away with the need to fasten seatbelts. In combination with the seatbelts, it offers the best combined protection in case of a serious accident.

Not wearing a seatbelt increases the chance of severe injury or death in a crash even when the vehicle has the SRS airbag.

- The SRS airbags deploy with considerable speed and force. Occupants who are out of proper position when the SRS airbag deploys could suffer very serious injuries. Because the SRS airbag needs enough space for deployment, the driver should always sit upright and well back in the seat as far from the steering wheel as practical while still maintaining full vehicle control and the front passenger should move the seat as far back as possible and sit upright and well back in the seat.

Carefully read the “Seatbelts” and “SRS airbag (Supplemental Restraint System airbag)” sections in chapter 1 for instructions and precautions concerning the seatbelt system and SRS airbag system.

■ Child safety

WARNING

- Never hold a child on your lap or in your arms while the vehicle is moving. The passenger cannot protect the child from injury in a collision, because the child will be caught between the passenger and objects inside the vehicle.
- While riding in the vehicle, infants and small children should always be placed in one of the rear seating positions recommended in this Owner's Manual in an infant or child restraint system which is appropriate for the child's age, height and weight. If a child is too big for a child restraint system, the child should sit in a REAR seat and be restrained using the seatbelts. According to accident statistics, children are safer when properly restrained in the rear seating positions than in the front seating positions. Never allow a child to stand up or kneel on the seat.
- Put children aged 12 and under in a REAR seat properly restrained

at all times in a child restraint device or in a seatbelt. The SRS airbag deploys with considerable speed and force and can injure or even kill children, especially if they are 12 years of age and under and are not restrained or improperly restrained. Because children are lighter and weaker than adults, their risk of being injured from deployment is greater.

- NEVER INSTALL A REARWARD FACING CHILD SAFETY SEAT IN THE FRONT SEAT. DOING SO RISKS SERIOUS INJURY OR DEATH TO THE CHILD BY PLACING THE CHILD'S HEAD TOO CLOSE TO THE SRS AIRBAG.
- Always use the child safety locks whenever a child rides in the rear. Serious injury could result if a child accidentally opened the door and fell out. Refer to the "Child safety locks" section in chapter 2.
- Always lock the passenger's windows using the lock switch when children are riding in the vehicle. Failure to follow this procedure could result in injury to a child operating the power window. Re-

fer to the "Power windows" section in chapter 2.

- Never leave unattended children in the vehicle. They could accidentally injure themselves or others through inadvertent operation of the vehicle. Also, on hot or sunny days, temperature in a closed vehicle could quickly become high enough to cause severe or possibly fatal injuries to them.

Carefully read the sections "Child restraint systems", "Seatbelts", and "SRS airbag (Supplemental Restraint System airbag)" in chapter 1 of this Owner's Manual for instructions and precautions concerning the child restraint system, seatbelt system and SRS airbag system.

■ Engine exhaust gas (carbon monoxide)

WARNING

- Never inhale engine exhaust gas. Engine exhaust gas contains carbon monoxide, a colorless and odorless gas which is dangerous, or even lethal, if inhaled.
- Always properly maintain the en-

– CONTINUED –

gine exhaust system to prevent engine exhaust gas from entering the vehicle.

- Never run the engine in a closed space, such as a garage, except for the brief time needed to drive the vehicle in or out of it.
- Avoid remaining in a parked vehicle for a lengthy time while the engine is running. If that is unavoidable, then use the ventilation fan to force fresh air into the vehicle.
- Always keep the front ventilator inlet grille free from snow, leaves or other obstructions to ensure that the ventilation system always works properly.
- If at any time you suspect that exhaust fumes are entering the vehicle, have the problem checked and corrected as soon as possible. If you must drive under these conditions, drive only with all windows fully open.
- Keep the rear gate closed while driving to prevent exhaust gas from entering the vehicle.

■ Drinking and driving

WARNING

Drinking and then driving is very dangerous. Alcohol in the bloodstream delays your reaction and impairs your perception, judgment and attentiveness. If you drive after drinking - even if you drink just a little - it will increase the risk of being involved in a serious or fatal accident, injuring or killing yourself, your passengers and others. In addition, if you are injured in the accident, alcohol may increase the severity of that injury.

Please don't drink and drive.

Drunken driving is one of the most frequent causes of accidents. Since alcohol affects all people differently, you may have consumed too much alcohol to drive safely even if the level of alcohol in your blood is below the legal limit. The safest thing you can do is never drink and drive. However if you have no choice but to drive, stop drinking and sober up completely before getting behind the wheel.

■ Drugs and driving

WARNING

There are some drugs (over the counter and prescription) that can delay your reaction time and impair your perception, judgment and attentiveness. If you drive after taking them, it may increase your, your passengers' and other persons' risk of being involved in a serious or fatal accident.

If you are taking any drugs, check with your doctor or pharmacist or read the literature that accompanies the medication to determine if the drug you are taking can impair your driving ability. Do not drive after taking any medications that can make you drowsy or otherwise affect your ability to safely operate a motor vehicle. If you have a medical condition that requires you to take drugs, please consult with your doctor.

Never drive if you are under the influence of any illicit mind-altering drugs. For your own health and well-being, we urge you not to take illegal drugs in the first place and to seek treatment if you are addicted to those drugs.

■ Driving when tired or sleepy

WARNING

When you are tired or sleepy, your reaction will be delayed and your perception, judgment and attentiveness will be impaired. If you drive when tired or sleepy, your, your passengers' and other persons' chances of being involved in a serious accident may increase.

Please do not continue to drive but instead find a safe place to rest if you are tired or sleepy. On long trips, you should make periodic rest stops to refresh yourself before continuing on your journey. When possible, you should share the driving with others.

■ Car phone/cell phone and driving

CAUTION

Do not use a car phone/cell phone while driving; it may distract your attention from driving and can lead to an accident. If you use a car phone/cell phone, pull off the road and park in a safe place before using your phone. In some States/Provinces, only hands-free phones may legally be used while driving.

■ Modification of your vehicle

CAUTION

Your vehicle should not be modified other than with genuine SUBARU parts and accessories. Other types of modifications could affect its performance, safety or durability, and may even violate governmental regulations. In addition, damage or performance problems resulting from modification may not be covered under warranties.

■ Driving a vehicle equipped with a navigation system

WARNING

Do not allow the monitor to distract your attention from driving. Also, do not operate the controls of the navigation system while driving. The loss of attention to driving could lead to an accident. If you wish to operate the controls of the navigation system, first take the vehicle off the road and stop it in a safe place.

■ Driving with pets

Unrestrained pets can interfere with your driving and distract your attention from driving. In a collision or sudden stop, unrestrained pets or cages can be thrown around inside the vehicle and hurt you or your passengers. Besides, the pets can be hurt under these situations. It is also for their own safety that pets should be properly restrained in your vehicle. Restraining a pet with a special traveling harness which can be secured to the rear seat with a seatbelt or use a pet carrier which can be secured to the rear seat by routing a seatbelt through the carrier's

– CONTINUED –

handle. Never restrain pets or pet carriers in the front passenger's seat. For further information, consult your veterinarian, local animal protection society or pet shop.

■ Tire pressures

WARNING

Driving at high speeds with excessively low tire pressures can cause the tires to deform severely and to rapidly become hot. A sharp increase in temperature could cause tread separation, and destruction of the tires. The resulting loss of vehicle control could lead to an accident.

Check and, if necessary, adjust the pressure of each tire (including the spare) at least once a month and before any long journey.

Check the tire pressure when the tires are cold.

Use a pressure gauge to adjust the tire pressures to the values shown on the tire placard.

Refer to the "Tires and wheels" section in chapter 11 for detailed information.

■ California proposition 65 warning

WARNING

Engine exhaust, some of its constituents, and certain vehicle components contain or emit chemicals known to the State of California to cause cancer and birth defects or other reproductive harm. In addition, certain fluids in vehicles and certain components of product wear contain or emit chemicals known to the State of California to cause cancer and birth defects or other reproductive harm.

■ On-pavement and off-road driving

This vehicle is classified as a utility vehicle. Utility vehicles have a significantly higher rollover rate than other types of vehicles. Your vehicle has a higher ground clearance and higher center of gravity, making it more likely to roll over than ordinary passenger cars. It also handles and maneuvers differently from other passenger cars. For this reason, please read carefully the "On-pavement and off road driving" section in chapter 8 of this

Owner's Manual and follow the instructions and precautions in order to prevent serious injury or death due to loss of control, rollover and other accidents.

Table of contents

<i>Seat, seatbelt and SRS airbags</i>	1
<i>Keys and doors</i>	2
<i>Instruments and controls</i>	3
<i>Climate control</i>	4
<i>Audio</i>	5
<i>Interior equipment</i>	6
<i>Starting and operating</i>	7
<i>Driving tips</i>	8
<i>In case of emergency</i>	9
<i>Appearance care</i>	10
<i>Maintenance and service</i>	11
<i>Specifications</i>	12
<i>Consumer information and Reporting safety defects</i>	13
<i>Index</i>	14

Illustrated index

■ Exterior

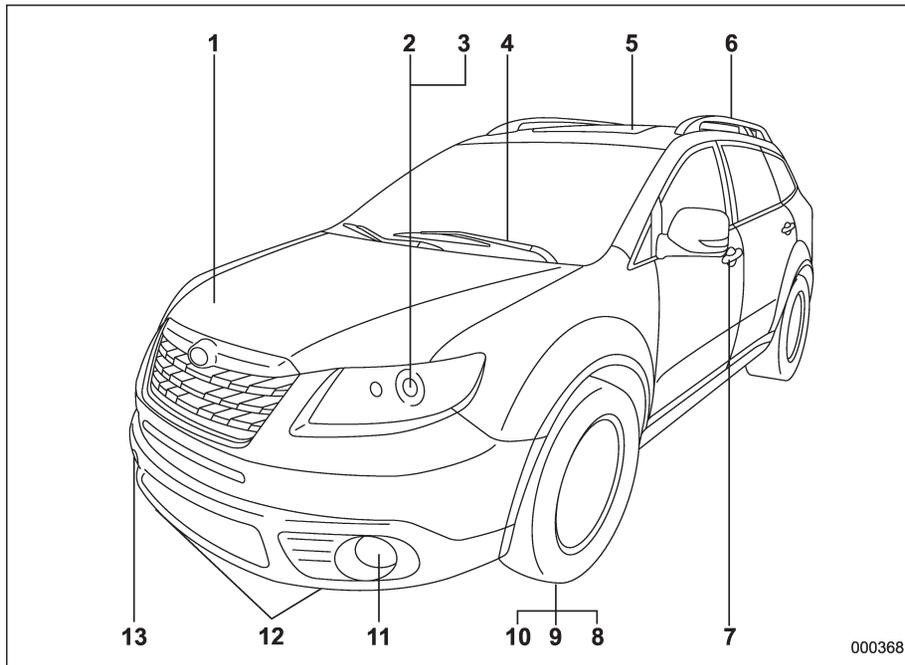

- 1) Engine hood lock release (page 11-4)
- 2) Headlight switch (page 3-26)
- 3) Bulb replacement (page 11-41)
- 4) Wiper switch (page 3-34)
- 5) Moonroof (page 2-24)
- 6) Roof rail (if equipped) (page 8-13)
- 7) Door locks (page 2-4)
- 8) Tire pressure (page 11-25)
- 9) Flat tires (page 9-6)
- 10) Tire chains (page 8-11)
- 11) Fog light switch (page 3-32)
- 12) Tie-down hooks (page 9-15)
- 13) Towing hook (page 9-15)

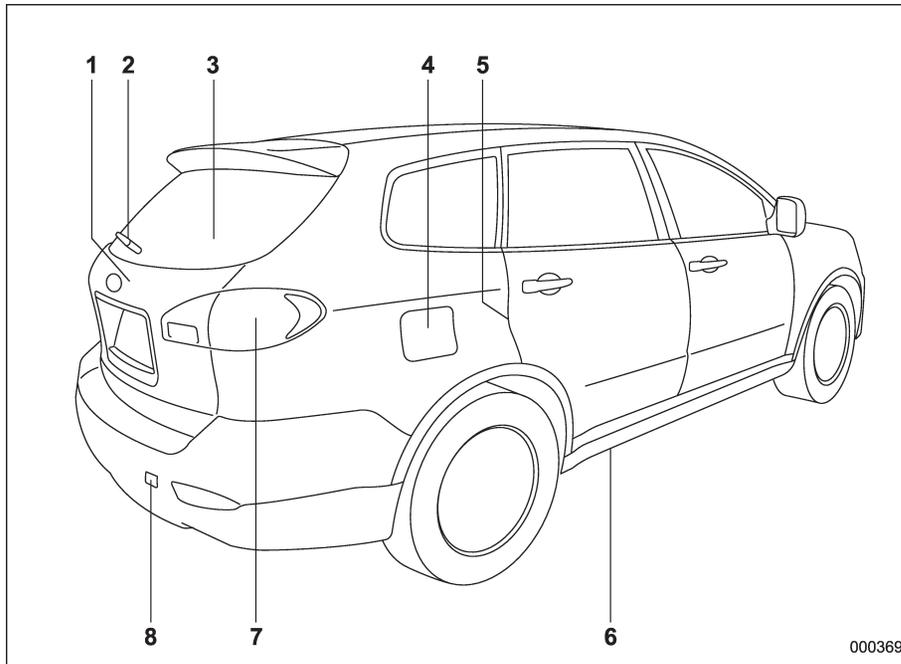

- 1) Rear gate (page 2-22)
- 2) Rear wiper switch (page 3-35)
- 3) Rear window defogger button (page 3-37)
- 4) Fuel filler lid and cap (page 7-3)
- 5) Child safety locks (page 2-19)
- 6) Tie-down hooks (page 9-15)
- 7) Bulb replacement (page 11-41)
- 8) Towing hook (page 9-15)

– CONTINUED –

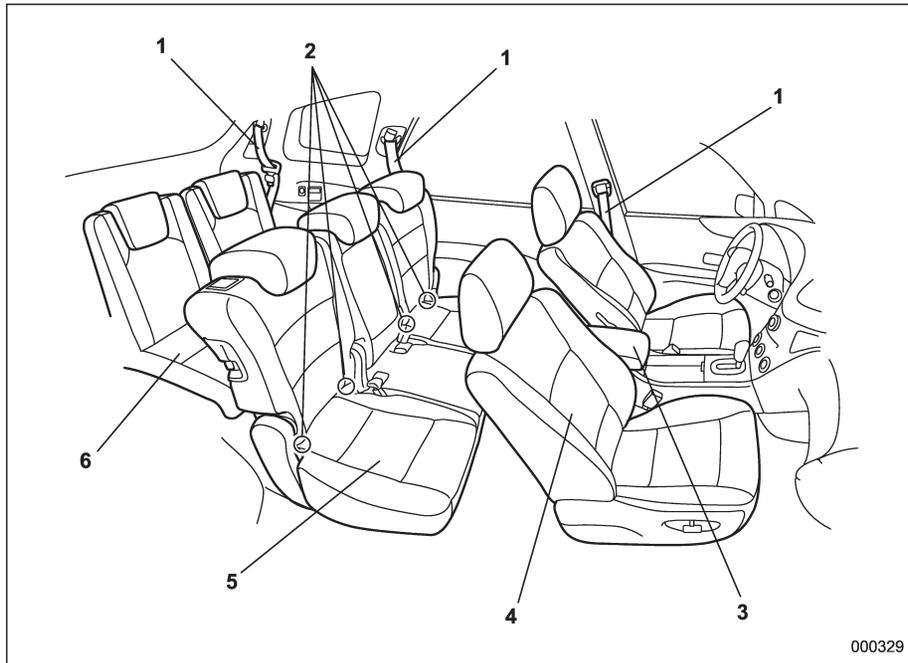
■ Interior**▼ Passenger compartment area**

000329

- 1) Seatbelt (page 1-16)
- 2) Lower anchorages for child restraint system (page 1-38)
- 3) Center console (page 6-6)
- 4) Front seat (page 1-2)
- 5) Second-row seat (page 1-7)
- 6) Third-row seat (page 1-13)

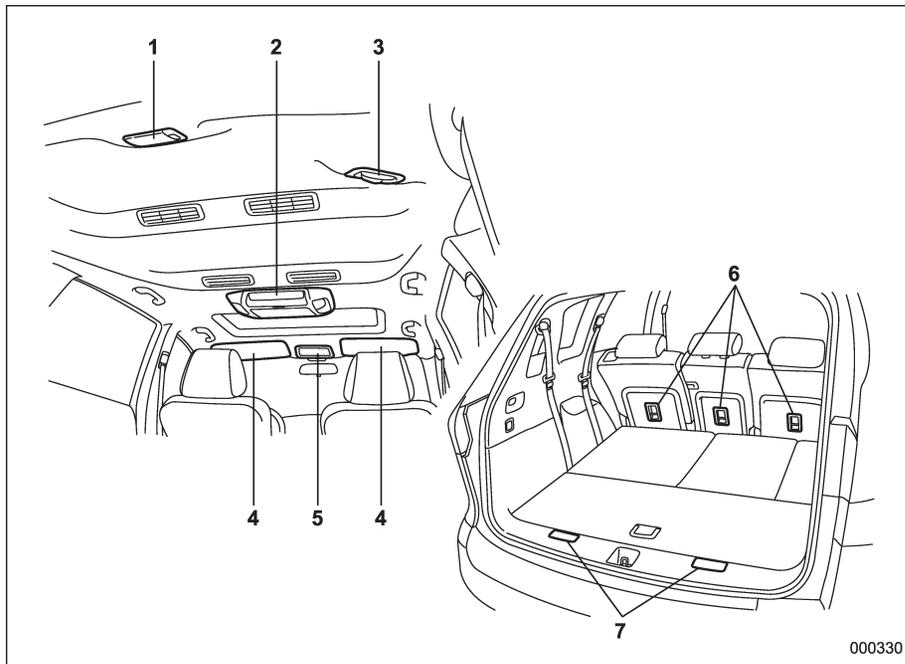

- 1) Cargo area light (page 6-2)
- 2) Dome lights (page 6-2)
- 3) Rear center seatbelt (page 1-23)
- 4) Sun visors (page 6-4)
- 5) Map light (page 6-3)
- 6) Top tether anchorages (rear seat/
second-row seat) (page 1-41)
- 7) Top tether anchorages (third-row seat)
(page 1-41)

– CONTINUED –

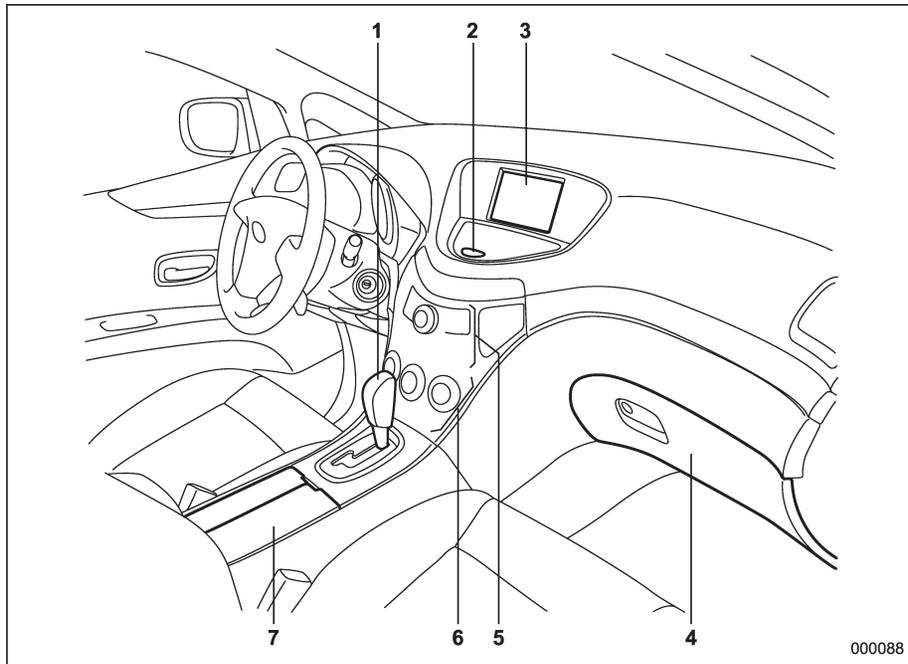

- 1) Selector lever (page 7-13)
- 2) Hazard warning flasher switch (page 3-5)
- 3) Multi function display (page 3-23)
- 4) Glove box (page 6-5)
- 5) Audio (page 5-1)
- 6) Climate control (page 4-1)
- 7) Cup holder (page 6-7)

000088

■ Instrument panel

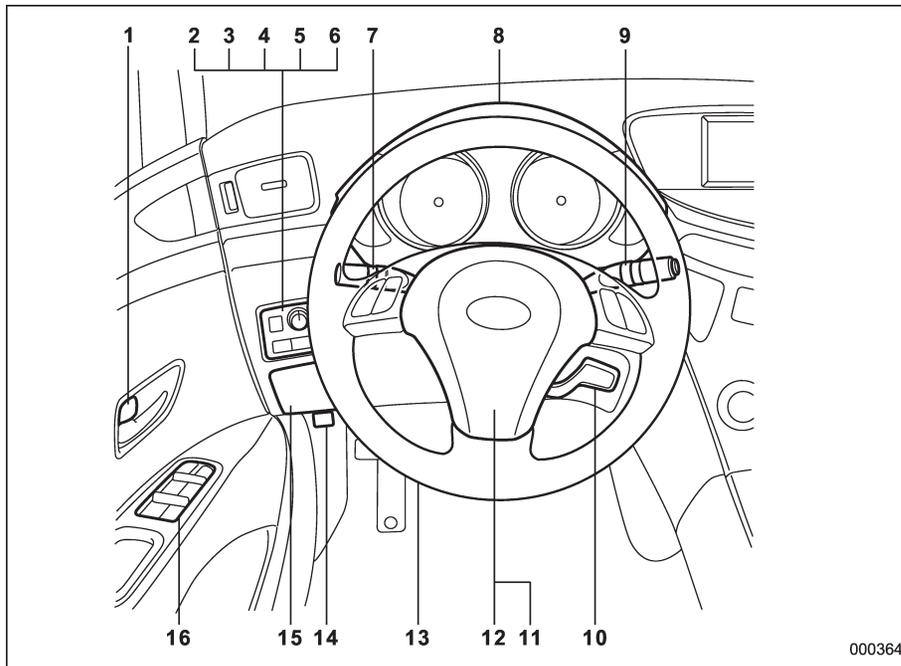

- 1) Door locks (page 2-4)
- 2) Illumination brightness control (page 3-28)
- 3) Remote control mirror switch (page 3-40)
Power folding mirror switch (if equipped) (page 3-41)
- 4) Windshield wiper deicer (page 3-36)
- 5) Traction Control system OFF switch (page 7-26)
- 6) Headlight beam leveler (if equipped) (page 3-29)
- 7) Light control switch (page 3-26)
- 8) Combination meter (page 3-5)
- 9) Wiper control lever (page 3-33)
- 10) Cruise control (page 7-30)
- 11) Horn (page 3-42)
- 12) SRS airbag (page 1-44)
- 13) Tilt steering (page 3-41)
- 14) Hood lock release knob (page 11-4)
- 15) Fuse box (page 11-38)
- 16) Power windows (page 2-20)

000364

- CONTINUED -

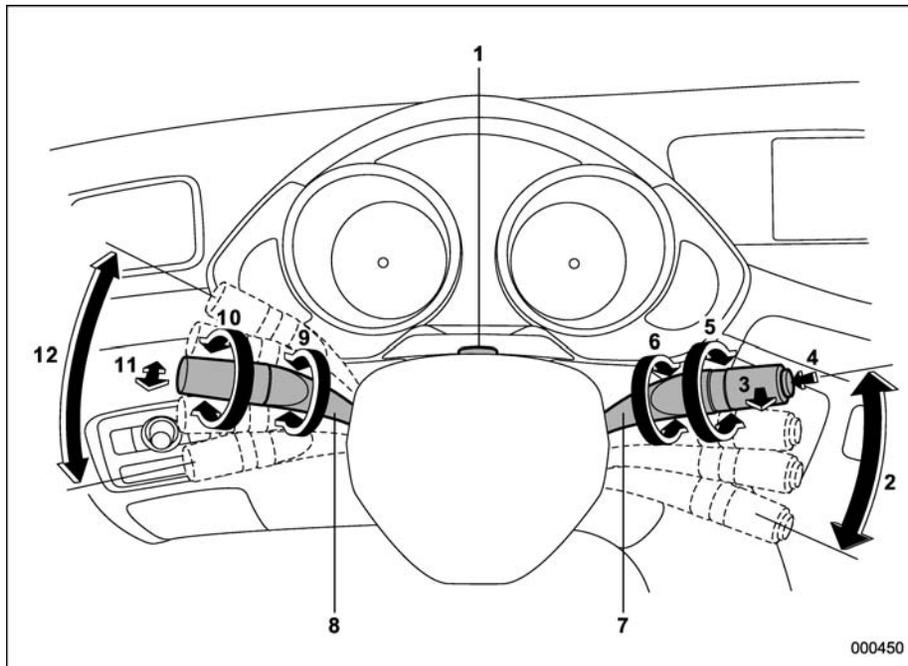
Light control and wiper control levers/switches

- 1) Parking light switch (page 3-32)
- 2) Windshield wiper (page 3-33)
- 3) Mist (page 3-34)
- 4) Windshield washer (page 3-35)
- 5) Rear window wiper and washer switch (page 3-35)
- 6) Wiper intermittent time control switch (page 3-34)
- 7) Wiper control lever (page 3-34)
- 8) Light control switch (page 3-26)
- 9) Fog light switch (page 3-32)
- 10) Headlight ON/OFF (page 3-26)
- 11) Headlight flasher High/Low beam change (page 3-27)
- 12) Turn signal (page 3-28)

■ Combination meter

▼ U.S.-spec. vehicles

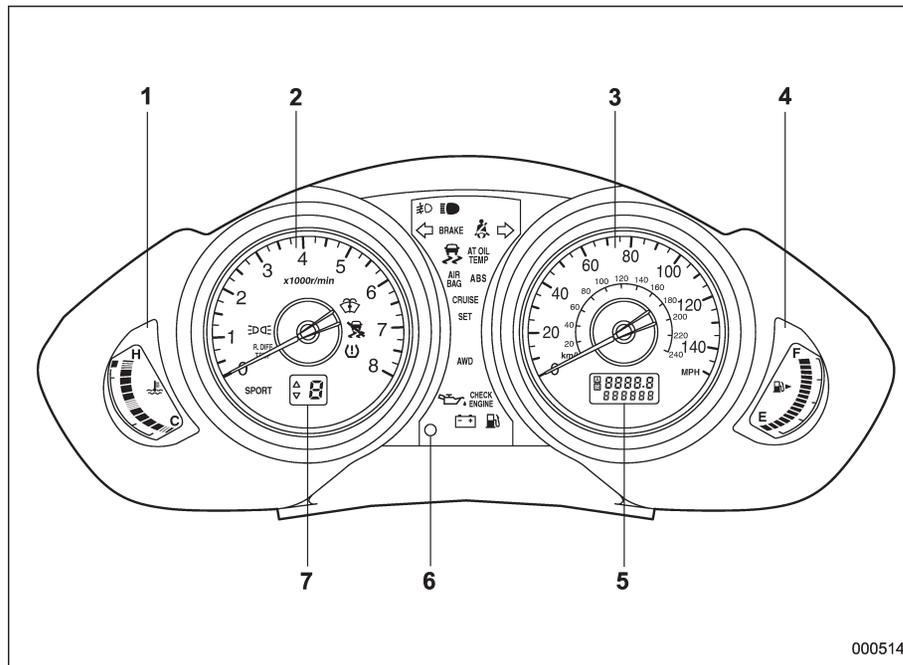

- 1) Temperature gauge (page 3-9)
- 2) Tachometer (page 3-7)
- 3) Speedometer (page 3-6)
- 4) Fuel gauge (page 3-8)
- 5) Trip meter and odometer (page 3-6/page 3-7)
- 6) Trip meter A/B selection and trip meter reset knob (page 3-7)
- 7) Selector lever/Gear position indicator (page 3-20)

– CONTINUED –

▼ Except U.S.-spec. vehicles

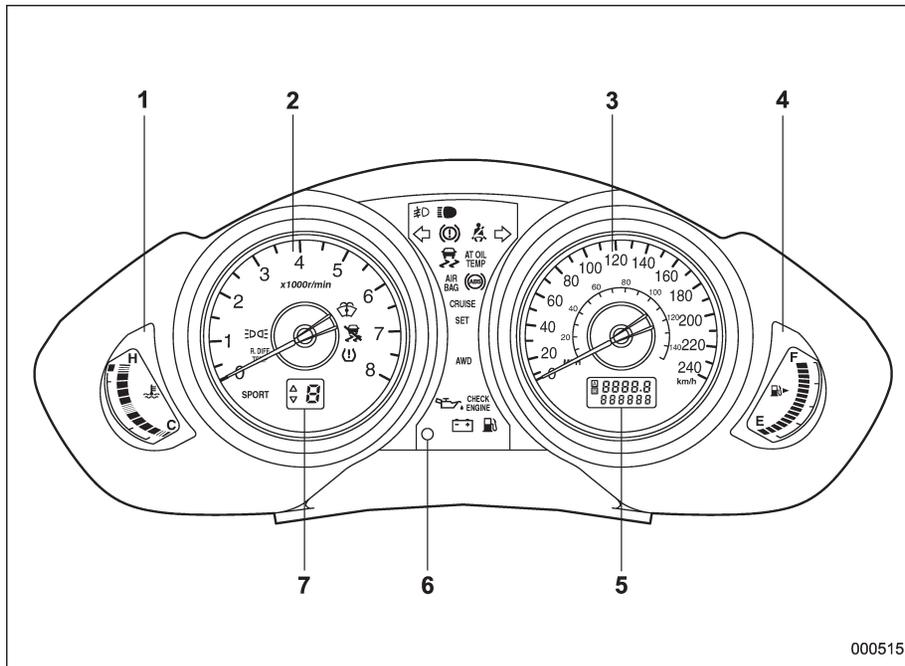

000515

- 1) Temperature gauge (page 3-9)
- 2) Tachometer (page 3-7)
- 3) Speedometer (page 3-6)
- 4) Fuel gauge (page 3-8)
- 5) Trip meter and odometer (page 3-6/page 3-7)
- 6) Trip meter A/B selection and trip meter reset knob (page 3-7)
- 7) Selector lever/Gear position indicator (page 3-20)

■ Warning and indicator lights

Mark	Name	Page
	Driver's seatbelt warning light	3-10
PASS 	Front passenger's seatbelt warning light	3-10
AIR BAG	SRS airbag system warning light	3-11
CHECK ENGINE	CHECK ENGINE warning light/Malfunction indicator lamp	3-12
	Charge warning light	3-13
	Oil pressure warning light	3-13
AT OIL TEMP	AT OIL TEMP warning light	3-13
ABS / 	ABS warning light	3-15
BRAKE / 	Brake system warning light	3-16
	Door open warning light	3-17
	Low fuel warning light	3-17
AWD	All-Wheel Drive warning light	3-18
	Vehicle Dynamics Control operation indicator light	3-18
	Vehicle Dynamics Control warning light/Traction Control system OFF indicator light	3-18
SECURITY ●	Security indicator light	3-19
	Turn signal indicator lights	3-20
	High beam indicator light	3-20
	Front fog light indicator light	3-21
	Headlight indicator light	3-21
CRUISE	Cruise control indicator light	3-20
SET	Cruise control set indicator light	3-21
	Low tire pressure warning light	3-14
ON 	Passenger airbag ON indicator light	3-12
OFF 	Passenger airbag OFF indicator light	3-12
SPORT	SPORT mode indicator light	3-20
	Windshield washer fluid warning light	3-18
R.DIFF TEMP	Rear differential oil temperature warning light	3-14

– CONTINUED –

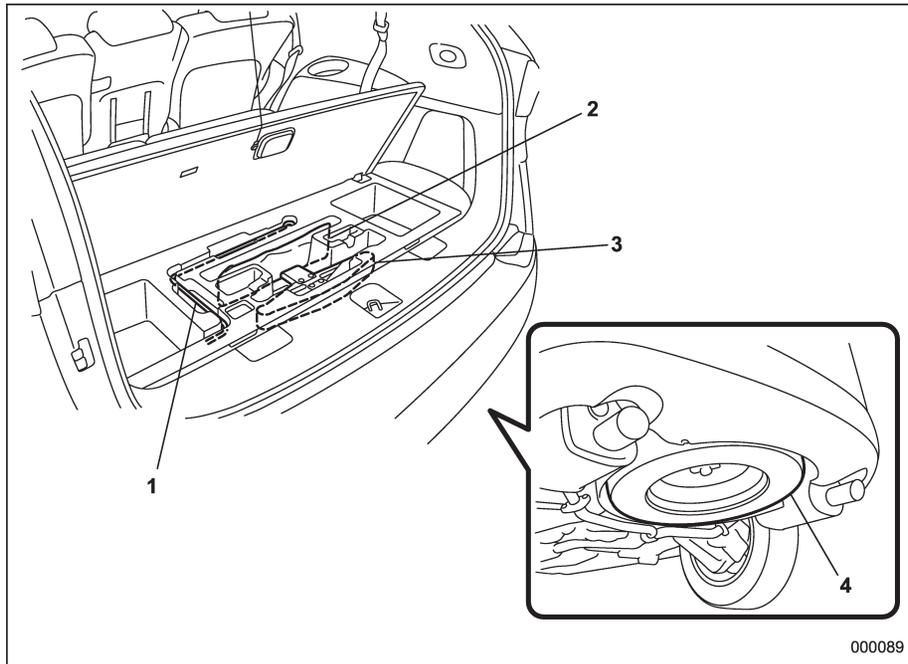
■ Cargo area**▼ 7-seater models**

- 1) Jack handle (page 9-19)
- 2) Maintenance tools (page 9-19)
- 3) Jack (page 9-19)
- 4) Spare tire (page 9-5)

000089

▼ 5-seater models

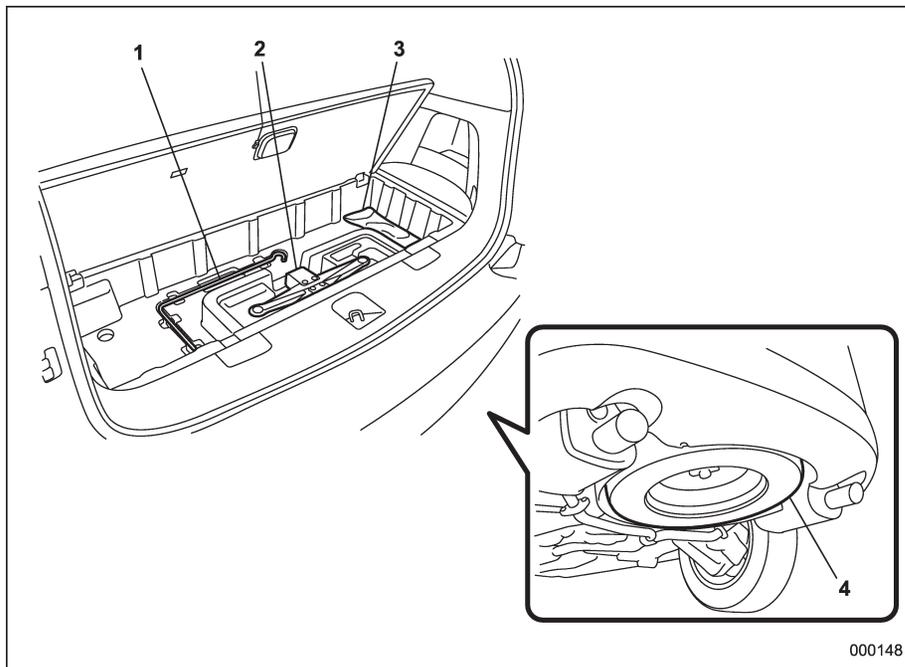

- 1) Jack handle (page 9-19)
- 2) Jack (page 9-19)
- 3) Maintenance tools (page 9-19)
- 4) Spare tire (page 9-5)

Function settings

A SUBARU dealer can change the settings of the functions shown in the following table to meet your personal requirements. Contact the nearest SUBARU dealer for details. If your vehicle is equipped with a genuine SUBARU navigation system, the settings for some of these functions can be changed using the monitor. For details, please refer to the Owner's Manual supplement for the navigation system.

Item	Function	Possible settings	Default setting	Page
Alarm system	Alarm system	Operation/Non-operation	Operation	2-15
	Monitoring start delay time (after closure of doors)	0 second/30 seconds	30 seconds	2-16
	Impact sensor operation (only vehicles with shock sensors (dealer option))	Operation/Non-operation	Non-operation	2-19
	Passive arming	Operation/Non-operation	Non-operation	2-18
Remote keyless entry system	Hazard warning flasher	Operation/Non-operation	Operation	2-8
	Audible signal	Operation/Non-operation	Operation	2-10
Key lock-in prevention	Key lock-in prevention	Operation/Non-operation	Operation	2-6
Rear window defogger	Rear window defogger	Operation for 15 minutes/Continuous operation	Operation for 15 minutes	3-37
Windshield wiper deicer	Windshield wiper deicer	Operation for 15 minutes/Continuous operation	Operation for 15 minutes	3-36
Map light/Dome light	Operation in interlock with remote keyless entry system	OFF/Short/Normal/Long	Normal	6-2
Battery drainage prevention function	Battery drainage prevention function	Operation/Non-operation	Operation	2-6

Seat, seatbelt and SRS airbags

Front seats	1-2	Fastening the seatbelt	1-19
Power seat.....	1-3	Seatbelt maintenance	1-27
Memory function (driver's seat – if equipped).....	1-4	Front seatbelt pretensioners	1-28
Head restraint adjustment.....	1-5	System monitors	1-29
Active head restraint	1-5	System servicing	1-30
Lumbar support	1-6	Precautions against vehicle modification	1-30
Seat heater (if equipped)	1-6	Child restraint systems	1-31
Rear seats (5-seater models)/Second-row seats (7-seater models)	1-7	Where to place a child restraint system.....	1-32
Forward and backward adjustment	1-8	Choosing a child restraint system	1-33
Reclining the seatback	1-9	Installing child restraint systems with A/ELR seatbelt	1-34
Folding down the seatback.....	1-9	Installing a booster seat.....	1-37
Head restraint adjustment.....	1-11	Installation of child restraint systems by use of lower and tether anchorages (LATCH)	1-38
Armrest	1-12	Top tether anchorages	1-41
Third-row seat (7-seater models)	1-13	*SRS airbag (Supplemental Restraint System airbag)	1-44
Access to the third-row seat.....	1-13	Your vehicle's SRS configuration	1-44
Folding down the seatback.....	1-14	SUBARU advanced frontal airbag system	1-48
Head restraint adjustment.....	1-15	SRS side airbag and SRS curtain airbag.....	1-58
Seatbelts	1-16	SRS airbag system monitors.....	1-69
Seatbelt safety tips.....	1-16	SRS airbag system servicing	1-70
Emergency Locking Retractor (ELR)	1-17	Precautions against vehicle modification.....	1-70
Automatic/Emergency Locking Retractor (A/ELR).....	1-17		
Seatbelt warning light and chime	1-18		

Front seats

▲ WARNING

- Never adjust the seat while driving to avoid the possibility of loss of vehicle control and of personal injury.
- Before adjusting the seat, make sure the hands and feet of rear seat passengers or luggage are clear of the adjusting mechanism.
- Seatbelts provide maximum restraint when the occupant sits well back and upright in the seat. To reduce the risk of sliding under the seatbelt in a collision, the front seatbacks should be always used in the upright position while the vehicle is running. If the front seatbacks are not used in the upright position in a collision, the risk of sliding under the lap belt and of the lap belt sliding up over the abdomen will increase, and both can result in serious internal injury or death.
- The SRS airbags deploy with considerable speed and force. Occupants who are out of proper

position when the SRS airbag deploys could suffer very serious injuries. Because the SRS airbag needs enough space for deployment, the driver should always sit upright and well back in the seat as far from the steering wheel as practical while still maintaining full vehicle control and the front passenger should move the seat as far back as possible and sit upright and well back in the seat.



▲ WARNING

Put children aged 12 and under in a rear seat properly restrained at all times. The SRS airbag deploys with

considerable speed and force and can injure or even kill children, especially if they are 12 years of age and under and are not restrained or improperly restrained. Because children are lighter and weaker than adults, their risk of being injured from deployment is greater. Consequently, we strongly recommend that ALL children (including those in child seats and those that have outgrown child restraint devices) sit in a REAR seat properly restrained at all times in a child restraint device or in a seatbelt, whichever is appropriate for the child's age, height and weight.

Always secure ALL types of child restraint devices (including forward facing child seats) in one of the rear seating positions recommended in this Owner's Manual.

NEVER INSTALL A REARWARD FACING CHILD SEAT IN THE FRONT SEAT. DOING SO RISKS SERIOUS INJURY OR DEATH TO THE CHILD BY PLACING THE CHILD'S HEAD TOO CLOSE TO THE SRS AIRBAG.

According to accident statistics, children are safer when properly restrained in the rear seating positions than in the front seating posi-

tions. For instructions and precautions concerning child restraint systems, refer to the “Child restraint systems” section in this chapter.

■ Power seat

▼ Forward and backward adjustment

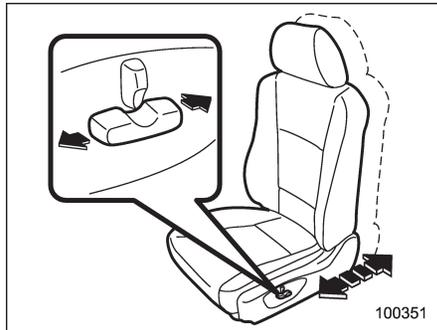

To adjust the seat forward or backward, move the control switch forward or backward.

NOTE

During backward-forward adjustment of the seat, you cannot adjust the seat cushion angle or seat height.

▼ Reclining the seatback

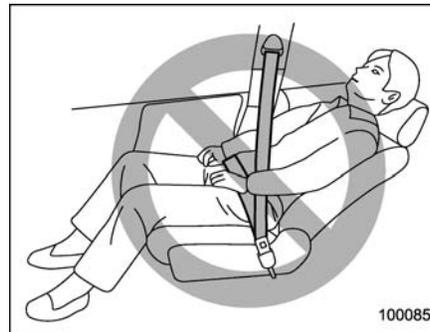

WARNING

To prevent the passenger from sliding under the seatbelt in the event of a collision, always put the seatback in the upright position while the vehicle is in motion. Also, do not place objects such as cushions between the passenger and the seatback. If you do so, the risk of sliding under the lap belt and of the lap belt sliding up over the abdomen will increase, and both can result in serious internal injury or death.

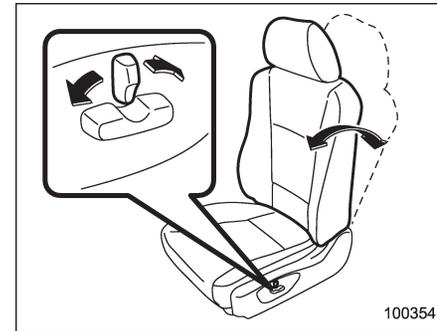

To adjust the angle of the seatback, move the control switch.

▼ Seat cushion angle adjustment (driver's seat)

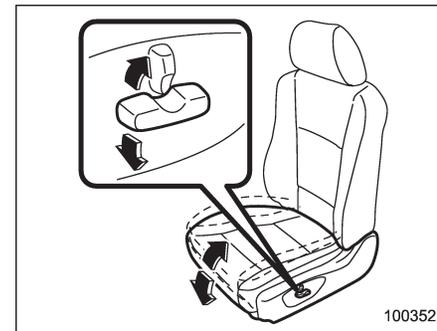

To adjust the seat cushion angle, pull up or push down the front end of the control

– CONTINUED –

1-4 Seat, seatbelt and SRS airbags

switch.

▼ Seat height adjustment (driver's seat)

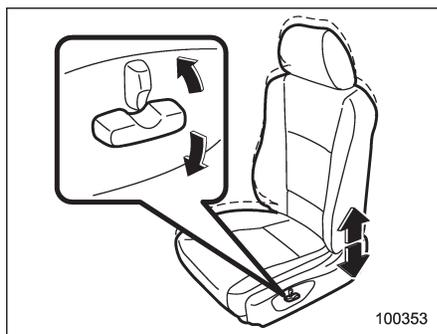

To adjust the seat height, pull up or push down the rear end of the control switch.

■ Memory function (driver's seat – if equipped)

Two of your favorite seat positions can be registered. Register the seat position with button “1” or “2” and retrieve the seat position by pressing either button.

The following seat positions can be registered:

- Forward/backward position of the seat
- Angle of seatback
- Angle of seat cushion

- Height of seat

▼ Registration of seat position

▲ WARNING

- Never adjust the seat while driving to avoid the possibility of loss of vehicle control and of personal injury.
- Before adjusting the seat, make sure the hands and feet of rear seat passengers or luggage are clear of the adjusting mechanism.

1. With the selector lever in the “P” position, adjust the seat position.

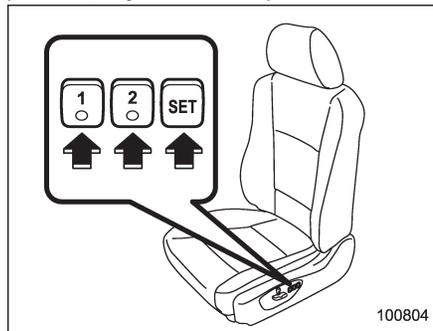

2. While pressing the “SET” button, press

the desired button “1” or “2”.

3. The chime sounds once, and the seat position is registered.

▼ Retrieval of seat position

▲ WARNING

- Never retrieve the seat position while driving to avoid the possibility of loss of vehicle control and of personal injury.
- Perform the seat position retrieval before driving. Be sure to confirm that the selector lever position is in the “P” position. Do not drive until the retrieval of the seat position is complete.
- Be sure to press the correct button to retrieve your registered seat position. If the seat position is not optimum for you, it may adversely affect your driving and may reduce the effectiveness of the seatbelt. That could result in an accident involving serious injury or death.
- When retrieving a registered seat position, make sure the hands, feet and possessions of rear seat passengers are clear of the seat adjusting mechanism.

- When any trouble or a malfunction occurs during the retrieval of the seat position, stop the retrieval of the seat position using any of the control switches for manual adjustment, seat memory set button, seat memory registered button 1 or 2.

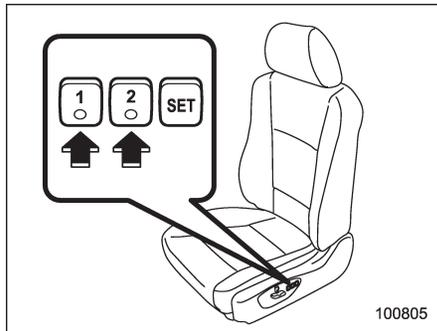

1. With the selector lever in the "P" position, press the desired button "1" or "2".
2. The chime sounds once and the seat moves to the registered position.
3. When the seat moves to the registered position, the chime sounds twice.

NOTE

- If a new position is registered for the same button, the previous seat position is deleted.
- Even if the battery is disconnected, the registered seat position is not deleted.

■ Head restraint adjustment

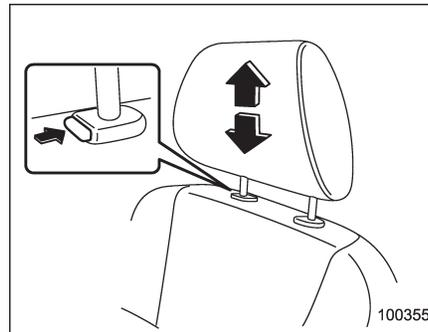

To raise:

Pull the head restraint up.

To lower:

Push the head restraint down while pressing the release button on the top of the seatback.

The head restraint should be adjusted so that the center of the head restraint is closest to the top of the occupant's ears.

⚠ WARNING

Never drive the vehicle with the head restraints removed because they are designed to reduce the risk of serious neck injury in the event that the vehicle is struck from the rear.

■ Active head restraint

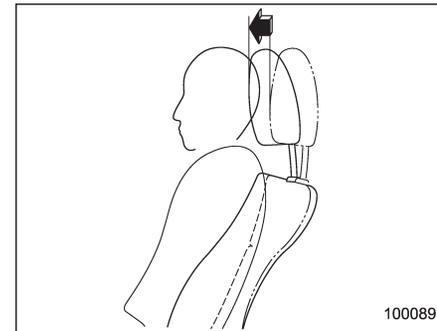

The front seats of your vehicle are equipped with active head restraints. They automatically tilt forward slightly in the event the vehicle is struck from the rear, decreasing the amount of rearward head movement and thus reducing the risk of whiplash. For maximum effectiveness the head restraint should be adjusted so that

– CONTINUED –

1-6 Seat, seatbelt and SRS airbags

the center of the head restraint is closest to the top of the occupant's ears.

CAUTION

- Each active head restraint is effective only when its height is properly adjusted and the driver/passenger sits in the correct position on the seat.
- If your vehicle is involved in a rear-end collision, have an authorized SUBARU dealer inspect the active head restraints.
- The active head restraints may not operate in the event the vehicle experiences only a slight impact in the rear.
- The active head restraints may be damaged if they are pushed hard from behind or subjected to shock. As a result, they may not function if the vehicle suffers a rear impact.

■ Lumbar support

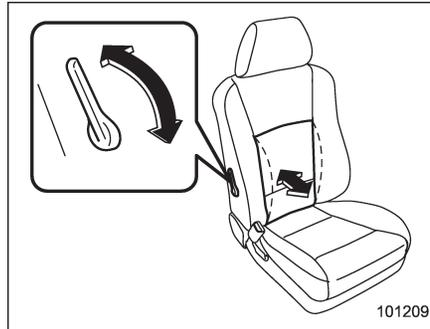

Pull the lever forward or backward.

Pulling the lever forward will increase the amount of support for your lower back.

Pulling the lever backward will decrease the amount of support for your lower back.

Seat heater (if equipped)

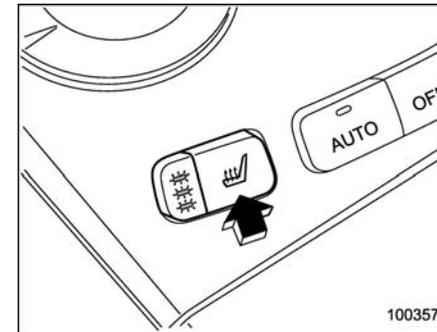

The seat heater is equipped in the front seats.

The seat heater operates when the ignition switch is in the "ON" position.

The seat heater can be adjusted in three levels. Press the button to activate the seat heater. Each subsequent press of the button will reduce the level. Pushing the button four times or keeping the button pressed for approximately 1 second will turn the heater off. While the seat heater is operating, its operating level is shown by the number of illuminated indicators. To warm the seat as quickly as possible, set the heater with three indicators illuminated.

When the vehicle's interior is warmed enough or before you leave the vehicle, be sure to turn the switch off.

CAUTION

- There is a possibility that people with delicate skin may suffer slight burns even at low temperatures if they use the seat heater for a long period of time. When using the heater, always be sure to warn the persons concerned.
- Do not put anything on the seat which insulates against heat, such as a blanket, cushion, or similar items. This may cause the seat heater to overheat.

NOTE

Use of the seat heater for a long period of time while the engine is not running can cause battery discharge.

**Rear seats (5-seater models)/
Second-row seats (7-seater models)**



WARNING

- Seatbelts provide maximum restraint when the occupant sits well back and upright in the seat. Do not put cushions or any other materials between occupants and seatbacks or seat cushions. If you do so, the risk of sliding under the lap belt and of the lap belt sliding up over the abdomen will increase, and both can result in serious internal injury or death.

- Before adjusting the seat, make sure the hands and feet of the rear seat passengers are clear of the adjusting mechanism (7-seater models only).

CAUTION

Never adjust the seat while driving. Doing so is dangerous as the seat could move rapidly and you could be injured.

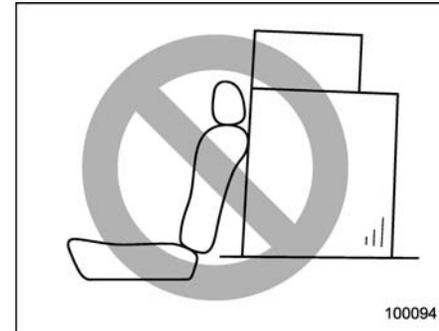

WARNING

Never stack luggage or other cargo higher than the top of the seatback because it could tumble forward and

1-8 Seat, seatbelt and SRS airbags

injure passengers in the event of a sudden stop or accident.

■ Forward and backward adjustment

▼ 5-seater models



100359

Pull the lever upward and slide the seat to the desired position. Then release the lever and move the seat back and forth to make sure that it is securely locked into place.

▼ 7-seater models

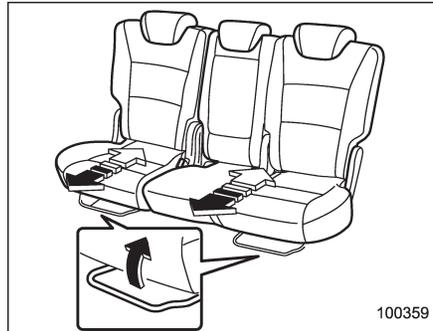

100359

Pull the lever upward and slide the seat to the desired position.

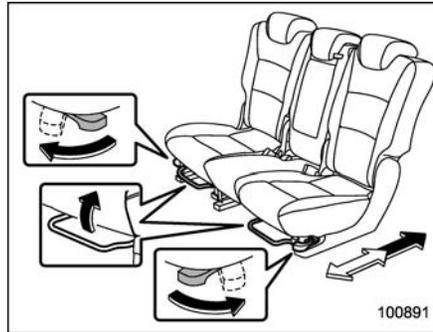

100891

When the right seat or the left seat pair is slid rearward, it stops partway at the lock point so as not to trap the legs of

passengers sitting on the third-row seat.

It is possible to slide the seat or seat pair further rearward by releasing the lock that stops it. To do this, simultaneously pull the lever under the outboard seat cushion and turn the lever on the side of the seat cushion outward when sliding the seat or seat pair.

Once you have released the lock, you can slide the seat or seat pair back and forth with only the lever under the seat cushion pulled. If you slide the seat or seat pair forward of the lock point, you will need to release the lock again before you can slide it behind the point.

Then release the lever and move the seat back and forth to make sure that it is securely locked into place.

⚠ CAUTION

If you slide the seat or seat pair aft of the lock point while the third-row seat is occupied, be careful not to trap the legs of the third-row passengers.

■ Reclining the seatback

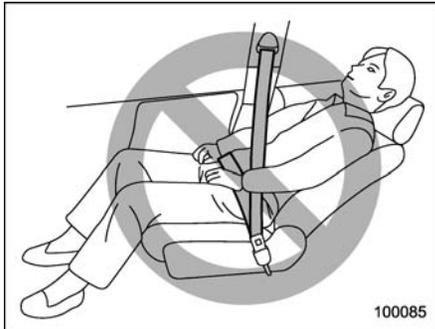

⚠ WARNING

To prevent the passenger from sliding under the seatbelt in the event of a collision, always put the seatback in the upright position while the vehicle is in motion. Also, do not place objects such as cushions between the passenger and the seatback. If you do so, the risk of sliding under the lap belt and of the lap belt sliding up over the abdomen will increase, and both can result in serious internal injury or death.

⚠ CAUTION

- In a 7-seater model vehicle, never allow the third-row seat passengers to adjust the seatback of the second row. Doing so is dangerous as the seatback will tilt rapidly and could injure the passengers.
- If the cargo area cover is equipped, be careful not to pinch your hand between the headrest and the cargo area cover when you recline the rear seat.

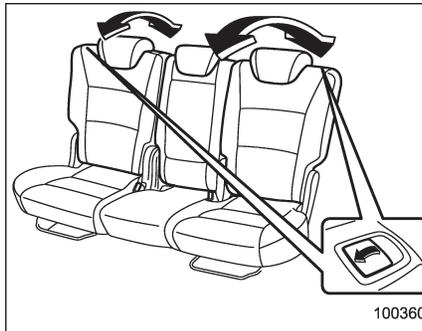

Pull the lever up and adjust the seatback to the desired position. Then release the lever and make sure the seatback is securely locked into place.

■ Folding down the seatback

⚠ WARNING

- After returning the seat to its original position, be certain to place all of the seatbelts and the tab attached to the seat cushion above the seat cushion. And make certain that the shoulder belts are fully visible.
- Never allow passengers to ride on the folded seatback or in the cargo area. Doing so may result in serious injury or death.
- Secure skis and other lengthy items properly to prevent them from being thrown around inside the vehicle and causing serious injury during a sudden stop, a sudden steering maneuver or a rapid acceleration.
- If passengers are sitting on the third-row seat, never drive while folding the second-row seat. It can be a serious interference at the time of braking and impact.
- If passengers are sitting on the third-row seat, never drive while the center seatback of the second-row seat is folded. Doing so

– CONTINUED –

1-10 Seat, seatbelt and SRS airbags

may result in serious injury in the event of a hard braking or an impact.

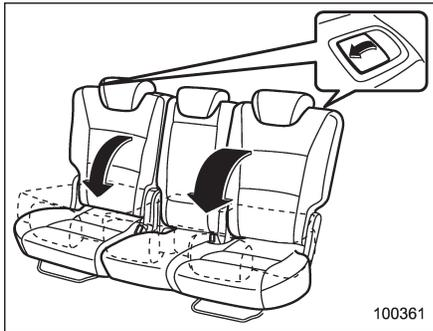

1. Slide the seat or seat pair to its rearmost position.
2. Lower the head restraint to its lowest position. Refer to the "Head restraint adjustment" in this section.
3. Unlock the seatback by pulling the lever and then fold the seatback down.
4. To return the seatback to its original position, raise the seatback until it locks into place. Make sure it is securely locked.

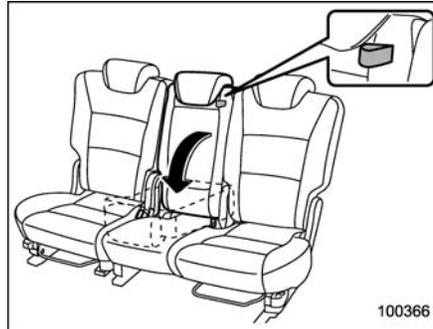

By pulling the tab on the center seat, you can fold only the seatback of the center seat.

To return the seatback to its original position, raise the seatback until it locks into place. Make sure it is securely locked.

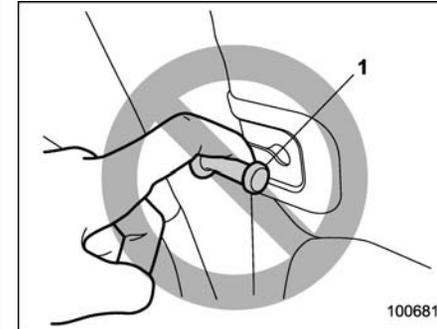

1) Bar

CAUTION

- **Folding the seatback of the center seat will expose the bar that retains it in the raised position. Be careful not to hurt yourself on it. Especially, do not rest your finger on the bar. Otherwise, when the seatback is raised, your finger could be pinched between the bar and seatback and thus injured.**

- Raise the seatback of the center seat while taking care not to trap your hands or other parts of the body between the center seat and window-side seat.

NOTE

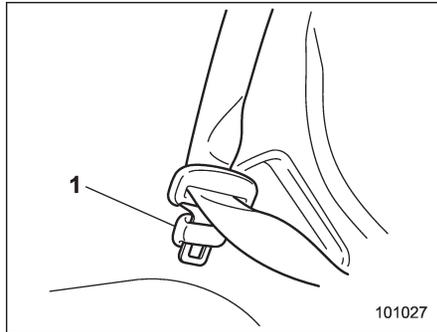

1) Holder

With the seatback folded, attach the tongue plate of each rear/second-row seatbelt to the corresponding holder. Do the same also before someone gets into the third-row seat.

Head restraint adjustment

WARNING

Never drive the vehicle with the head restraints removed because they are designed to reduce the risk of serious neck injury in the event that the vehicle is struck from the rear.

CAUTION

The head restraint is not intended to be used at the lowest position. Before sitting on the seat, raise the head restraint to an appropriate position depending on your sitting height.

Window side seats

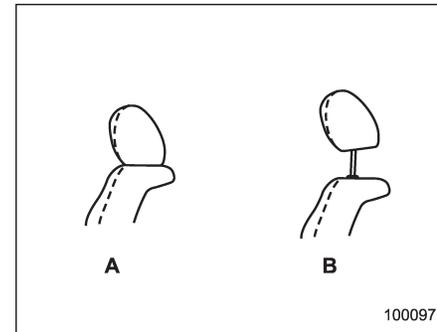

- A) When not used (retracted position)
- B) When used (extended position)

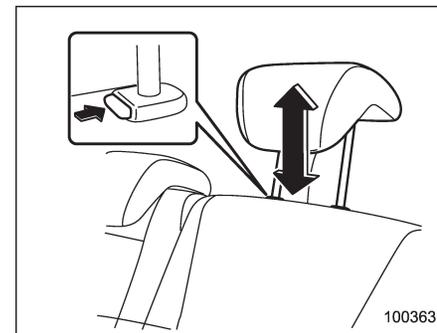

To raise:
Pull the head restraint up.

- CONTINUED -

1-12 Seat, seatbelt and SRS airbags

To lower:

Push the head restraint down while pressing the release button on the top of the seatback.

The head restraint should be adjusted so that the center of the head restraint is closest to the top of the occupant's ears. When the seats are not occupied, lower the head restraints to improve rearward visibility.

▼ Center seat

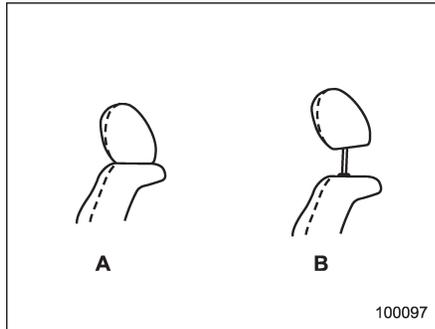

- A) When not used (retracted position)
- B) When used (extended position)

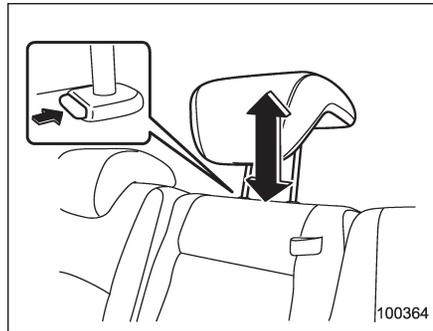

To raise:

Pull the head restraint up.

To lower:

Push the head restraint down while pressing the release button on the top of the seatback.

The head restraint should be adjusted so that the center of the head restraint is closest to the top of the occupant's ears. When the center seat is not occupied, lower the head restraint to improve rearward visibility.

■ Armrest



To lower the armrest, pull on the strap of the armrest.

▲ WARNING

To avoid the possibility of serious injury, passengers must never be allowed to sit on the center armrest while the vehicle is in motion.

Third-row seat (7-seater models)



⚠ WARNING

Seatbelts provide maximum restraint when the occupant sits well back and upright in the seat. Do not put cushions or any other materials between occupants and seatbacks or seat cushions. If you do so, the risk of sliding under the lap belt and of the lap belt sliding up over the abdomen will increase, and both can result in serious internal injury or death.

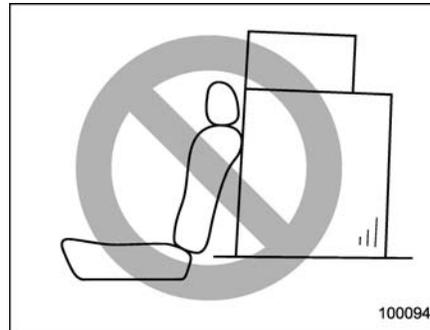

⚠ WARNING

Never stack luggage or other cargo higher than the top of the seatback because it could tumble forward and injure passengers in the event of a sudden stop or accident.

■ Access to the third-row seat

There are levers on both sides of the second-row seat. Each lever is used to facilitate access to the third-row seat.

⚠ WARNING

In its slid-forward position with the seatback tipped forward, the second-row seat is not locked and free

to move. Do not drive the vehicle with the seat in this state or allow anyone to sit on the seat unless it is completely locked. Doing so may result in serious injury or death.

⚠ CAUTION

When getting into or out of the third-row seat, make sure the second-row seat is in the completely slid-forward position and be sure to watch your step.

▼ To access the third-row seat

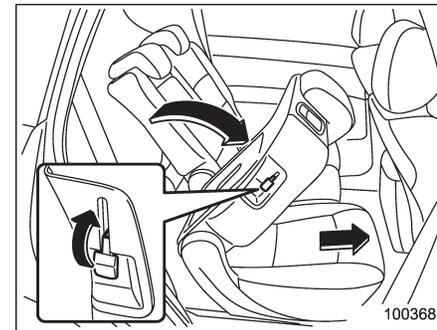

Raise the lever. The seatback of the second-row seat will tip forward and the seat will slide forward.

– CONTINUED –

1-14 Seat, seatbelt and SRS airbags

Before driving the vehicle, adjust the fore/aft position of the second-row seat, raise the seatback, and make sure the seatback is securely locked in position.

▼ To get out from the third-row seat

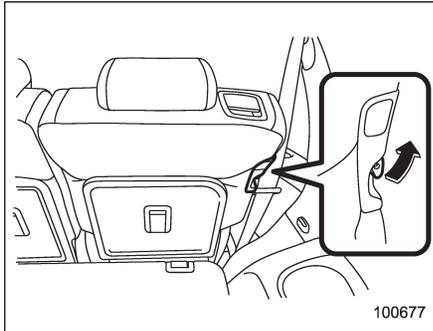

Raise the lever from the third-row seat. The seatback of the second-row seat will tip forward and the seat will slide forward. Before driving the vehicle, adjust the fore/aft position of the second-row seat, raise the seatback, and make sure the seatback is securely locked in position.

■ Folding down the seatback

▲ WARNING

- After returning the seat to its original position, be certain to place all of the seatbelts and the tab attached to the seat cushion above the seat cushion. And make certain that the shoulder belts are fully visible.
- Never allow passengers to ride on the folded seatback or in the cargo area. Doing so may result in serious injury or death.
- Secure skis and other lengthy items properly to prevent them from being thrown around inside the vehicle and causing serious injury during a sudden stop, a sudden steering maneuver or a rapid acceleration.

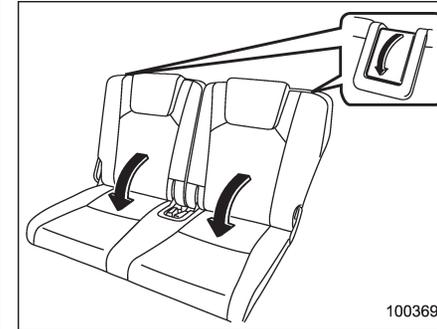

Place the head restraint in its lowest position, pull up the lever to release the seatback lock, and fold down the seatback. Refer to "Head restraint adjustment" in this section.

To return the seatback to its original position, raise the seatback until it locks into place. Make sure it is securely locked.

NOTE

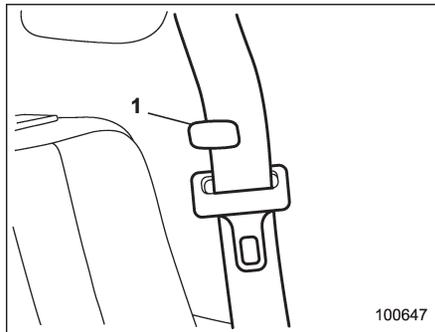

1) Holder

- Before folding or raising the seatback of the third-row seat, confirm that the seatbelt is flat against the sidewall at the lower point and the webbing is attached to the holder.
- When raising the seatback of the third-row seat, if the seatbelt catches on the seatback, hold the belt forward of the seatback while latching the seatback.

Head restraint adjustment

WARNING

Never drive the vehicle with the head restraints removed because they are designed to reduce the risk of serious neck injury in the event that the vehicle is struck from the rear.

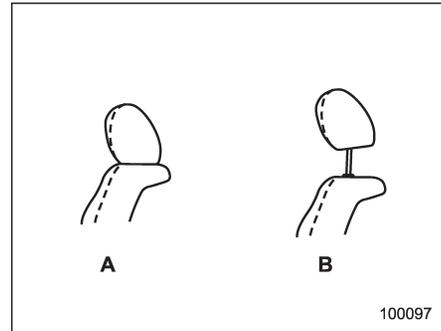

- A) When not used (retracted position)
- B) When used (extended position)

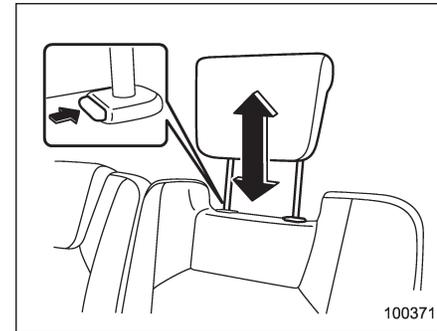

To raise:

Pull the head restraint up.

To lower:

Push the head restraint down while pressing the release button on the top of the seatback.

The head restraint should be adjusted so that the center of the head restraint is closest to the top of the occupant's ears. When the seats are not occupied, lower the head restraints to improve rearward visibility.

 **CAUTION**

The head restraint is not intended to be used at the lowest position. Before sitting on the seat, raise the head restraint to an appropriate position depending on your sitting height.

Seatbelts

■ Seatbelt safety tips

 **WARNING**

- All persons in the vehicle should fasten their seatbelts **BEFORE** the vehicle starts to move. Otherwise, the possibility of serious injury becomes greater in the event of a sudden stop or accident.
- All belts should fit snugly in order to provide full restraint. Loose fitting belts are not as effective in preventing or reducing injury.
- Each seatbelt is designed to support only one person. Never use a single belt for two or more persons – even children. Otherwise, in an accident, serious injury or death could result.
- Replace all seatbelt assemblies including retractors and attaching hardware worn by occupants of a vehicle that has been in a serious accident. The entire assembly should be replaced even if damage is not obvious.
- Put children aged 12 and under in

a rear seat properly restrained at all times. The SRS airbag deploys with considerable speed and force and can injure or even kill children, especially if they are 12 years of age and under and are not restrained or improperly restrained. Because children are lighter and weaker than adults, their risk of being injured from deployment is greater. Consequently, we strongly recommend that **ALL** children (including those in child seats and those that have outgrown child restraint devices) sit in a **REAR** seat properly restrained at all times in a child restraint device or in a seatbelt, whichever is appropriate for the child's height and weight.

Always secure **ALL** types of child restraint devices (including forward facing child seats) in one of the rear seating positions recommended in this Owner's Manual.

NEVER INSTALL A REARWARD FACING CHILD SEAT IN THE FRONT SEAT. DOING SO RISKS SERIOUS INJURY OR DEATH TO THE CHILD BY PLACING THE CHILD'S HEAD TOO CLOSE TO

THE SRS AIRBAG.

According to accident statistics, children are safer when properly restrained in the rear seating positions than in the front seating positions. For instructions and precautions concerning the child restraint system, refer to the “Child restraint systems” section in this chapter.

Your vehicle is equipped with a crash sensing and diagnostic module, which will record the use of the seatbelt(s) by the driver and front passenger when any of the SRS frontal, side and curtain airbags deploy.

▼ Infants or small children

Use a child restraint system that is suitable for your vehicle. Refer to the information on “Child restraint systems” in this chapter.

▼ Children

If a child is too big for a child restraint system, the child should sit in the rear seat and be restrained using the seatbelts. According to accident statistics, children are safer when properly restrained in the rear seating positions than in the front seating positions. Never allow a child to stand up or kneel on the seat.

If the shoulder portion of the belt crosses the face or neck, adjust the shoulder belt anchor height (window-side seating positions only) and then if necessary move the child closer to the belt buckle to help provide a good shoulder belt fit. Care must be taken to securely place the lap belt as low as possible on the hips and not on the child's waist. If the shoulder portion of the belt cannot be properly positioned, a child restraint system should be used. Never place the shoulder belt under the child's arm or behind the child's back.

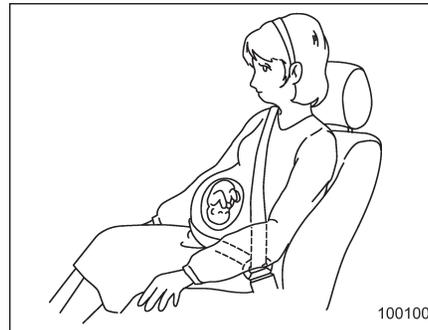
▼ Expectant mothers

Expectant mothers also need to use the seatbelts. They should consult their doctor for specific recommendations. The lap belt should be worn securely and as low as possible over the hips, not over the waist.

■ Emergency Locking Retractor (ELR)

The driver's seatbelt has an Emergency Locking Retractor (ELR).

The emergency locking retractor allows normal body movement but the retractor locks automatically during a sudden stop, impact or if you pull the belt very quickly out of the retractor.

■ Automatic/Emergency Locking Retractor (A/ELR)

Each passenger's seatbelt has an Automatic/Emergency Locking Retractor (A/ELR). The Automatic/Emergency Locking Retractor normally functions as an Emergency Locking Retractor (ELR). The A/ELR has an additional locking mode “Automatic Locking Retractor (ALR) mode” intended to secure a child restraint system. When the seatbelt is once drawn out completely and is then retracted even slightly, the retractor locks the seatbelt in that position and the seatbelt cannot be extended. As the belt is rewinding, clicks will be heard which indicate the retractor functions as ALR. When the seatbelt is retracted fully, ALR mode is released.

When securing a child restraint system on the passengers' seats, the seatbelt must be changed over to the Automatic Locking

– CONTINUED –

Retractor (ALR) mode.

When the child restraint system is removed, make sure that the retractor is restored to the Emergency Locking Retractor (ELR) function by allowing the seatbelt to retract fully.

For instructions on how to convert the retractor to the ALR mode and restore it to the ELR mode, refer to the "Installing child restraint systems with A/ELR seatbelt" section in this chapter.

■ Seatbelt warning light and chime



Your vehicle is equipped with a seatbelt warning device at the driver's and front passenger's seat.

With the ignition switch turned to the "ON" position, this device reminds the driver and front passenger to fasten their seatbelts by illuminating the warning lights in the locations indicated in the following illustrations and sounding a chime.

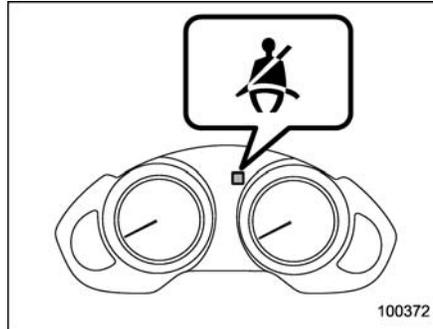

Driver's warning light

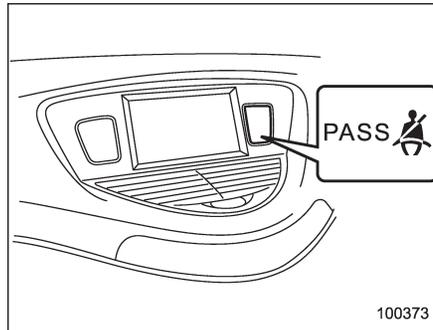

Front passenger's warning light

▼ Operation

If the driver and/or front passenger have/has not yet fastened the seatbelt(s) when

the ignition switch is turned to the "ON" position, the seatbelt warning light(s) will flash for 6 seconds, to warn that the seatbelt(s) is/are unfastened. If the driver's seatbelt is not fastened, a chime will also sound simultaneously.

NOTE

- If the driver's and/or front passenger's seatbelt(s) is/are still not fastened 6 seconds later, the seatbelt warning device operates as follows according to the vehicle speed.

- At speeds lower than approximately 9 mph (15 km/h)

The warning light(s) for unfastened seatbelt(s) will alternate between steady illumination and flashing at 15-second intervals. The chime will not sound.

- At speeds higher than approximately 9 mph (15 km/h)

The warning light(s) for unfastened seatbelt(s) will alternate between flashing and steady illumination at 15-second intervals and the chime will sound while the warning light(s) is/are flashing.

- It is possible to cancel the warning operation that follows the 6-second warning after turning ON the ignition switch. When the ignition switch is

turned ON next time, however, the complete sequence of the warning operation resumes. For further details about canceling the warning operation, please contact your SUBARU dealer.

If there is no passenger on the front passenger's seat, the seatbelt warning device for the front passenger's seat will be deactivated. The front passenger's occupant detection system monitors whether or not there is a passenger on the front passenger's seat.

Observe the following precautions. Failure to do so may prevent the device from functioning correctly or cause the device to fail.

- Do not install any accessory such as a table or TV onto the seatback.
- Do not store a heavy load in the seatback pocket.
- Do not allow the rear seat/second-row seat occupant to place his/her hands or legs on the front passenger's seatback, or allow him/her to pull the seatback.

If the seatbelt warning device for the front passenger's seat does not function correctly (e.g., it is activated even when the front passenger's seat is empty or it is deactivated even when the front passenger has not fastened his/her seatbelt), take the following actions.

- Ensure that no article is placed on the seat other than a child restraint system and the child occupant.
- Ensure that there is no article left in the seatback pocket.

If the seatbelt warning device for front passenger's seat still does not function correctly after taking relevant corrective actions described above, immediately contact your SUBARU dealer for an inspection.

■ Fastening the seatbelt

WARNING

- **Never use a belt that is twisted or reversed. In an accident, this can increase the risk or severity of injury.**
- **Keep the lap belt as low as possible on your hips. In a collision, this spreads the force of the lap belt over stronger hip bones instead of across the weaker abdomen.**
- **Seatbelts provide maximum restraint when the occupant sits well back and upright in the seat. To reduce the risk of sliding under the seatbelt in a collision,**

the front seatbacks should be always used in the upright position while the vehicle is running. If the front seatbacks are not used in the upright position in a collision, the risk of sliding under the lap belt and of the lap belt sliding up over the abdomen will increase, and both can result in serious internal injury or death.

- **Do not put cushions or any other materials between occupants and seatbacks or seat cushions. If you do so, the risk of sliding under the lap belt and of the lap belt sliding up over the abdomen will increase, and both can result in serious internal injury or death.**

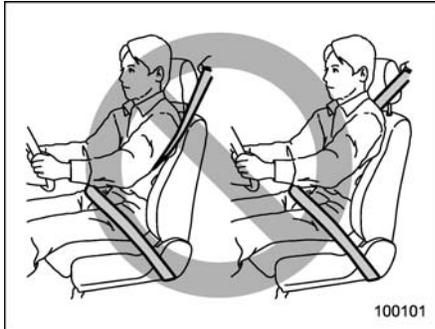

⚠ WARNING

Never place the shoulder belt under the arm or behind the back. If an accident occurs, this can increase the risk or severity of injury.

⚠ CAUTION

Metallic parts of the seatbelt can become very hot in a vehicle that has been closed up in sunny weather; they could burn an occupant. Do not touch such hot parts until they cool.

▼ **Front seatbelts**

1. Adjust the seat position:

Driver's seat: Adjust the seatback to the upright position. Move the seatback as far from the steering wheel as practical while still maintaining full vehicle control.

Front passenger's seat: Adjust the seatback to the upright position. Move the seat as far back as possible.

2. Sit well back in the seat.

3. Pick up the tongue plate and pull the belt out slowly. Do not let it get twisted. If the belt stops before reaching the buckle, return the belt slightly and pull it out more slowly. If the belt still cannot be unlocked, let the belt retract slightly after giving it a strong pull, then pull it out slowly again.

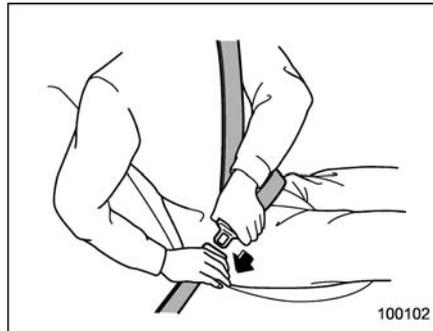

4. Insert the tongue plate into the buckle

until you hear a click.

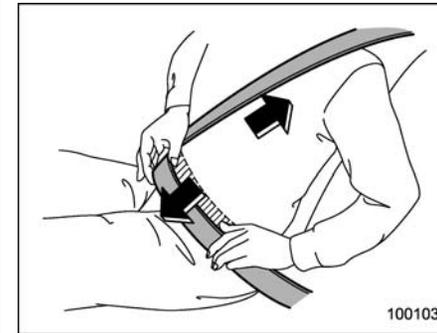

5. To make the lap part tight, pull up on the shoulder belt.
6. Place the lap belt as low as possible on your hips, not on your waist.

▽ Adjusting the front seat shoulder belt anchor height

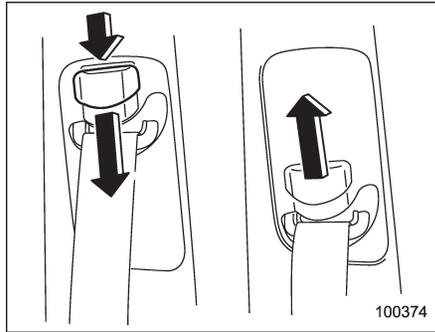

The shoulder belt anchor height should be adjusted to the position best suited for the driver/front passenger. Always adjust the anchor height so that the shoulder belt passes over the middle of the shoulder without touching the neck.

To raise:

Slide the anchor up.

To lower:

Push the release button and slide the anchor down.

Pull down on the anchor to make sure that it is locked in place.

WARNING

When wearing the seatbelts, make sure the shoulder portion of the webbing does not pass over your neck. If it does, adjust the seatbelt anchor to a lower position. Placing the shoulder belt over the neck may result in neck injury during sudden braking or in a collision.

▽ Unfastening the seatbelt

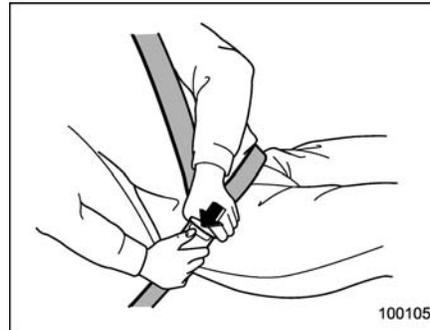

Push the button on the buckle.

Before closing the door, make sure that the belts are retracted properly to avoid catching the belt webbing in the door.

▼ Rear seatbelts (5-seater models)/ Second-row seatbelts (7-seater models) – excluding center seatbelt

1. Sit well back in the seat.
2. Pick up the tongue plate and pull the belt out slowly. Do not let it get twisted. If the belt stops before reaching the buckle, return the belt slightly and pull it out more slowly. If the belt still cannot be unlocked, let the belt retract slightly after giving a strong pull on it, then pull it out slowly again.

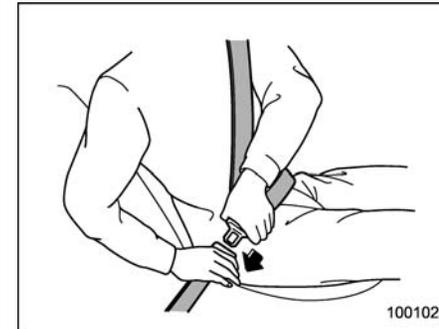

3. Insert the tongue plate into the buckle until you hear a click.

– CONTINUED –

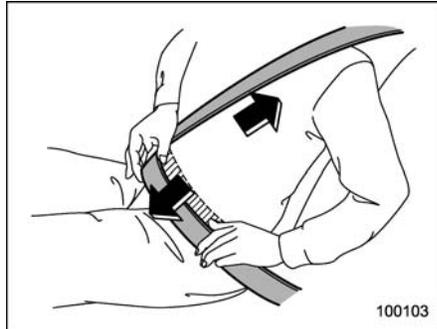

4. To make the lap part tight, pull up on the shoulder belt.
5. Place the lap belt as low as possible on your hips, not on your waist.

▽ Adjusting the shoulder belt anchor height (rear seats of 5-seater models/second-row seats of 7-seater models)

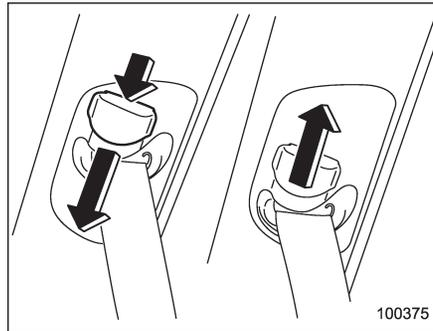

The shoulder belt anchor height should be adjusted to the position best suited for the passenger. Always adjust the anchor height so that the shoulder belt passes over the middle of the shoulder without touching the neck.

To raise:

Slide the anchor up.

To lower:

Push the release button and slide the anchor down.

Pull down on the anchor to make sure that it is locked in place.

⚠ WARNING

When wearing the seatbelts, make sure the shoulder portion of the webbing does not pass over your neck. If it does, adjust the seatbelt anchor to a lower position. Placing the shoulder belt over the neck may result in neck injury during sudden braking or in a collision.

▽ Unfastening the seatbelt

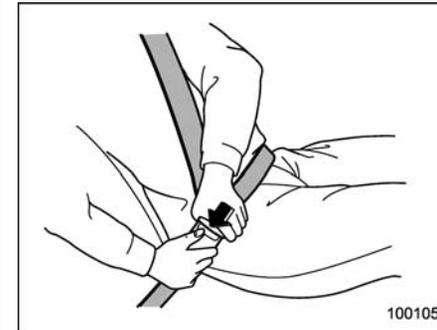

Push the button on the buckle.

Before closing the door, make sure that the belts are retracted properly to avoid catching the belt webbing in the door.

NOTE

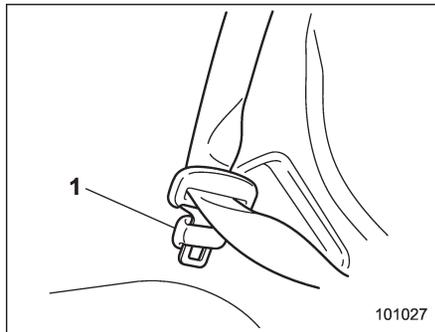

1) Holder

With the seatback folded, attach the tongue plate of each rear/second-row seatbelt to the corresponding holder. Do the same also before someone gets into the third-row seat.

▼ **Rear center seatbelt (5-seater models)/second-row center seatbelt (7-seater models)**

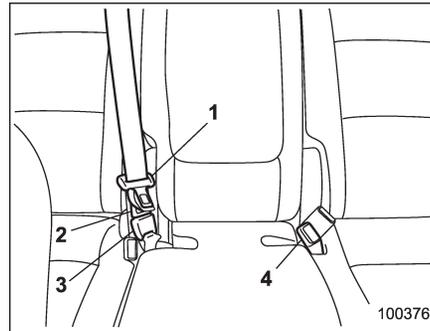

- 1) Center seatbelt tongue plate
- 2) Connector (tongue)
- 3) Connector (buckle)
- 4) Center seatbelt buckle

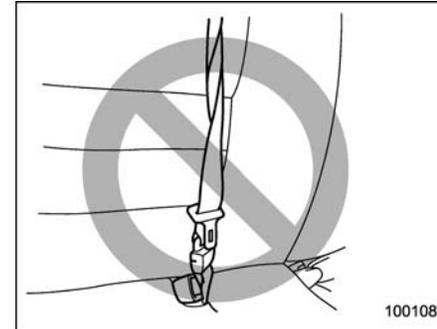

⚠ WARNING

Fastening the seatbelt with the webbing twisted can increase the risk or severity of injury in an accident. When fastening the belt after it is pulled out from the retractor, especially when inserting the connector's tongue plate into the mating buckle (on right-hand side), always check that the webbing is not twisted.

1-24 Seat, seatbelt and SRS airbags



WARNING

Be sure to fasten both tongue plates to the respective buckles. If the seatbelt is used only as a shoulder belt (with the connector's tongue plate not fastened to the connector's buckle on the right-hand side), it cannot properly restrain the wearer in position in an accident, possibly resulting in serious injury or death.

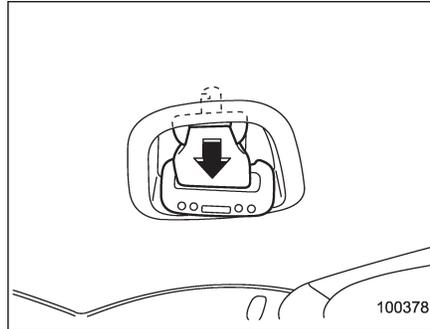

Center seatbelt is stowed in the recess of the ceiling.

1. Remove the connector (tongue) plate from the slot located at the front of the recess by pulling the connector (tongue) plate rearward.

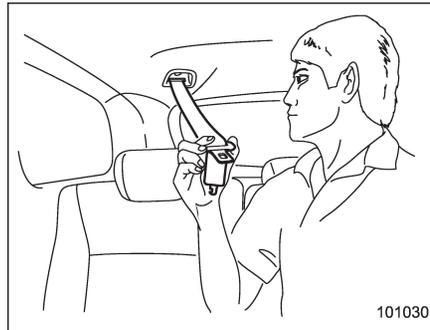

2. Pull out the seatbelt slowly from the overhead retractor.

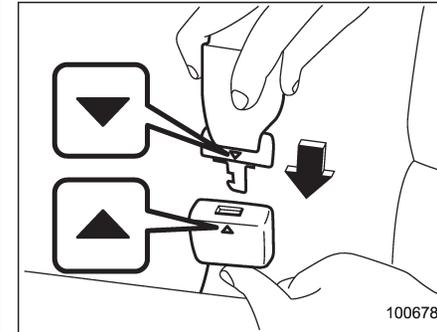

3. After confirming that the webbing is not twisted, insert the connector (tongue) attached at the webbing end into the buckle on the right-hand side until a click is heard. Make sure that the “▼” mark on the connector (tongue) and the “▲” mark on the buckle are aligned.

If the belt stops before reaching the buckle, return the belt slightly and pull it out more slowly. If the belt still cannot be unlocked, let the belt retract slightly after giving it a strong pull, then pull it out slowly again.



4. Insert the center seatbelt tongue plate in the center seatbelt buckle marked "CENTER" on the left-hand side until it clicks.

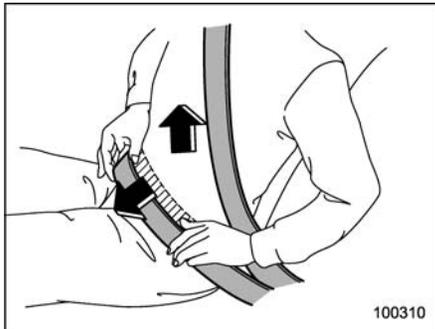

5. To make the lap part tight, pull up on the shoulder belt. And place the lap belt as

low as possible on your hips, not on your waist.

▽ Unfastening the seatbelt

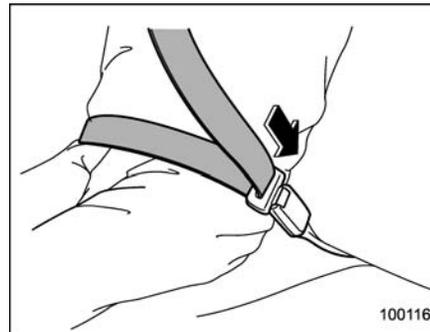

Push the release button of the center seatbelt buckle (on the left-hand side) to unfasten the seatbelt.

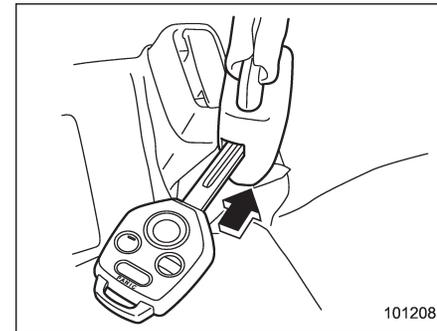

1. Insert a key or other hard pointed object into the slot in the connector (buckle) on the right-hand side and push it in, and the connector (tongue) plate will disconnect from the buckle.

- CONTINUED -

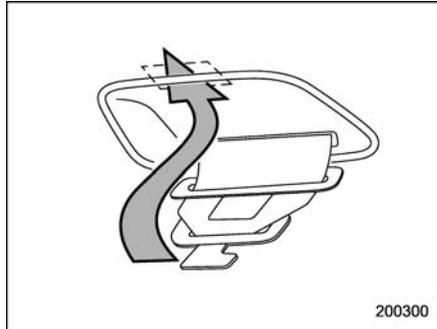

2. With the belt held by hand, allow the retractor to roll up the belt slowly. You should hold the webbing end and guide it back into the retractor while it is rolling up. Neatly store the tongue plate in the recess on the ceiling and then insert the connector (tongue) plate into the slot located at the front of the recess.

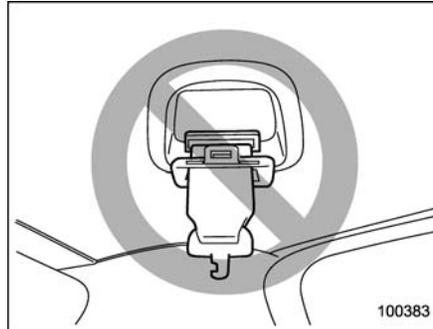

CAUTION

- Do not allow the retractor to roll up the seatbelt too quickly. Otherwise, the metal tongue plates may hit against the trim, resulting in damaged trim.
- Have the seatbelt fully rolled up so that the tongue plates are neatly stored. A hanging tongue plate can swing and hit against the trim during driving, causing damage to the trim.

▼ **Third-row seatbelt (7-seater models)**

1. Sit well back in the seat.
2. Pick up the tongue plate and pull the belt out slowly. Do not let it get twisted. If the belt stops before reaching the buckle, return the belt slightly and pull it out more slowly. If the belt still cannot be unlocked, let the belt retract slightly after giving a strong pull on it, then pull it out slowly again.

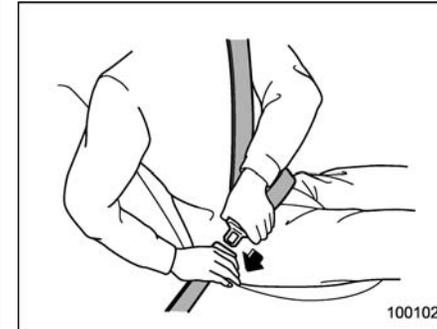

3. Insert the tongue plate into the buckle until you hear a click.

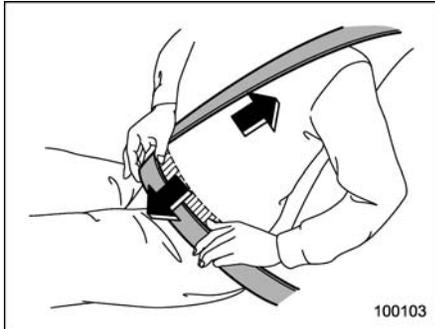

4. To make the lap part tight, pull up on the shoulder belt.
5. Place the lap belt as low as possible on your hips, not on your waist.

▽ Unfastening the seatbelt

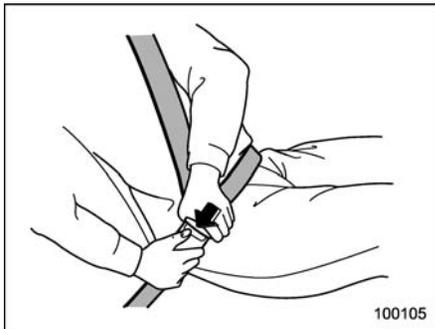

Push the button on the buckle.

NOTE

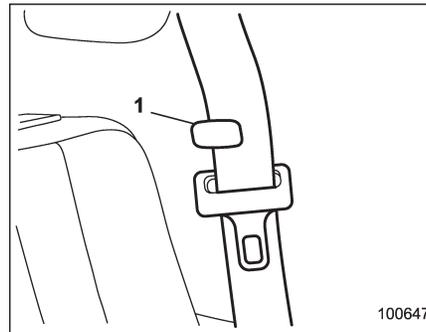

1) Holder

- Before folding or raising the seatback of the third-row seat, confirm that the seatbelt is flat against the sidewall at the lower point and the webbing is attached to the holder.
- When raising the seatback of the third-row seat, if the seatbelt catches on the seatback, hold the belt forward of the seatback while latching the seatback.

■ **Seatbelt maintenance**

To clean the seatbelts, use a mild soap and lukewarm water. Never bleach or dye the belts because this could seriously affect their strength.

Inspect the seatbelts and attachments including the webbing and all hardware periodically for cracks, cuts, gashes, tears, damage, loose bolts or worn areas. Replace the seatbelts even if only minor damage is found.

CAUTION

- Keep the belts free of polishes, oils, chemicals and particularly battery acid.
- Never attempt to make modifications or changes that will prevent the seatbelt from operating properly.

Front seatbelt pretensioners



The driver's and front passenger's seatbelts have a seatbelt pretensioner. The seatbelt pretensioners for the driver's seat and front passenger's seat operate at the same time as the frontal, and side SRS airbags. If the vehicle rolls over, they operate simultaneously with the curtain airbag.

The front and side airbag sensors and the rollover sensor are used as the pretensioner sensors. If a sensor detects a certain predetermined amount of force during a frontal collision, a side impact collision or a rollover collision of the vehicle, the front seatbelt is quickly drawn back in by the retractor to take up the slack so that the belt more effectively

restrains the front seat occupant.

When a seatbelt pretensioner is activated, an operating noise will be heard and a small amount of smoke will be released. These occurrences are normal and not harmful. This smoke does not indicate a fire in the vehicle.

Once the seatbelt pretensioner has been activated, the seatbelt retractor remains locked. Consequently, the seatbelt can not be pulled out and retracted and therefore must be replaced.

NOTE

- Seatbelt pretensioners are not designed to activate in minor frontal impacts, in minor side impacts or rear impacts.
- The seatbelt pretensioners for the driver's seat and front passenger's seat operate at the same time as the frontal, and side SRS airbags. If the vehicle rolls over, they operate simultaneously with the curtain airbag.
- Pretensioners are designed to function on a one-time-only basis. In the event that a pretensioner is activated, both the driver's and front passenger's seatbelt retractor assemblies must be replaced and only by an authorized SUBARU dealer. When replacing seat-

belt retractor assemblies, use only genuine SUBARU parts.

- If either front seatbelt does not retract or cannot be pulled out due to a malfunction or activation of the pretensioner, contact your SUBARU dealer as soon as possible.
- If the front seatbelt retractor assembly or surrounding area has been damaged, contact your SUBARU dealer as soon as possible.
- When you sell your vehicle, we urge you to explain to the buyer that it has seatbelt pretensioners by alerting him to the contents of this section.

⚠ WARNING

- To obtain maximum protection, occupants should sit in an upright position with their seatbelts properly fastened. Refer to the "Seatbelts" section in this chapter.
- Do not modify, remove or strike the front seatbelt retractor assemblies or surrounding area. This could result in accidental activation of the seatbelt pretensioners or could make the system inoperative, possibly resulting in serious injury. Seatbelt

pretensioners have no user-serviceable parts. For required servicing of front seatbelt retractors equipped with seatbelt pretensioners, see your nearest SUBARU dealer.

- When discarding front seatbelt retractor assemblies or scrapping the entire vehicle due to collision damage or for other reasons, consult your SUBARU dealer.

■ System monitors

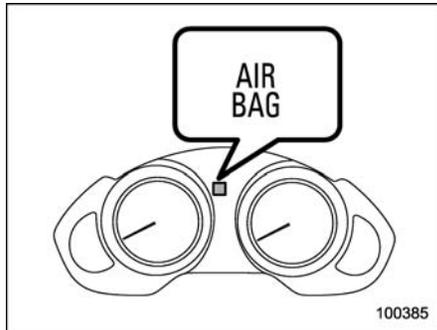

SRS airbag system warning light

A diagnostic system continually monitors the readiness of the seatbelt pretensioner while the vehicle is being driven. The

seatbelt pretensioners share the control module with the airbag system. Therefore, if any malfunction occurs in a seatbelt pretensioner, the SRS airbag system warning light will illuminate. The SRS airbag system warning light will show normal system operation by lighting for approximately 6 seconds when the ignition switch is turned to the "ON" position.

The following components are monitored by the indicator:

- Front sub sensor (right-hand side)
- Front sub sensor (left-hand side)
- Airbag control module (including impact and rollover sensors)
- Frontal airbag module (driver's side)
- Frontal airbag module (front passenger's side)
- Side airbag sensor (center pillar right-hand side)
- Side airbag sensor (center pillar left-hand side)
- Side airbag module (driver's side)
- Side airbag module (front passenger's side)
- Curtain airbag sensor (rear wheel house right-hand side)
- Curtain airbag sensor (rear wheel house left-hand side)
- Curtain airbag module (right side)
- Curtain airbag module (left side)
- Seatbelt pretensioner (driver's side)
- Seatbelt pretensioner (front passenger's side)
- Seatbelt buckle switch (driver's side)
- Seatbelt buckle switch (front passenger's side)
- Driver's seat position sensor
- Front passenger's seatbelt tension sensor
- Front passenger's occupant detection system weight sensor
- Front passenger's occupant detection control module
- Front passenger's frontal airbag ON and OFF indicator
- All related wiring

WARNING

If the warning light exhibits any of the following conditions, there may be a malfunction in the seatbelt pretensioners and/or SRS airbag system. Immediately take your vehicle to your nearest SUBARU dealer to have the system checked. Unless checked and properly repaired, the seatbelt pretensioners and/or SRS airbags will operate improperly (e.g. SRS airbags may inflate in a very

– CONTINUED –

minor collision or not inflate in a severe collision), which may increase the risk of injury.

- Flashing or flickering of the warning light
- No illumination of the warning light when the ignition switch is first turned to the "ON" position
- Continuous illumination of the warning light
- Illumination of the warning light while driving

■ System servicing

WARNING

- When discarding a seatbelt retractor assembly or scrapping the entire vehicle damaged by a collision, consult your SUBARU dealer.
- Tampering with or disconnecting the system's wiring could result in accidental activation of the seatbelt pretensioner and/or airbag or could make the system inoperative, which may result in serious injury. Do not use electrical test equipment on any

circuit related to the seatbelt pretensioner and airbag systems. For required servicing of the seatbelt pretensioner, see your nearest SUBARU dealer.

CAUTION

The front sub sensors are located on both sides of the radiator panel, and the airbag control module including the impact sensors is located under the center console. If you need service or repair in those areas or near the front seatbelt retractors, we recommend that you have an authorized SUBARU dealer perform the work.

NOTE

If the front part of the vehicle is damaged in an accident to the extent that the seatbelt pretensioner does not operate, contact your SUBARU dealer as soon as possible.

■ Precautions against vehicle modification

Always consult your SUBARU dealer if you want to install any accessory parts to your vehicle.

CAUTION

Do not perform any of the following modifications. Such modifications can interfere with proper operation of the seatbelt pretensioners.

- Attachment of any equipment (bush bar, winches, snow plow, skid plate, etc.) other than genuine SUBARU accessory parts to the front end.
- Modification of the suspension system or front end structure.
- Installation of a tire of different size and construction from the tires specified on the vehicle placard attached to the door pillar or specified for individual vehicle models in this Owner's Manual.

Child restraint systems

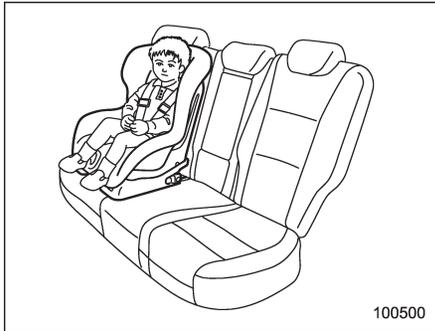

While riding in the vehicle, infants and small children should always be placed in an infant or child restraint system in one of the rear seating positions recommended in this Owner's Manual.

You should use an infant or child restraint system that meets Federal Motor Vehicle Safety Standards or Canada Motor Vehicle Safety Standards, is compatible with your vehicle and is appropriate for the child's age and size.

All child restraint systems are designed to be secured in vehicle seats by lap belts or the lap belt portion of a lap/shoulder belt (except those covered under the section in this manual, entitled "Installation of child

restraint systems by use of lower and tether anchorages (LATCH)").

Children could be endangered in an accident if their child restraints are not properly secured in the vehicle. When installing the child restraint system, carefully follow the manufacturer's instructions.

According to accident statistics, children are safer when properly restrained in the rear seating positions than in the front seating positions.

All U.S. states and Canadian provinces require that infants and small children be restrained in an approved child restraint system at all times while the vehicle is moving.



WARNING

Never let a passenger hold a child on his or her lap while the vehicle is moving. The passenger cannot protect the child from injury in a collision, because the child will be caught between the passenger and objects inside the vehicle. Additionally, holding a child in your lap or arms in the front seat exposes that child to another serious danger. Since the SRS airbag deploys with considerable speed and force, the child could be injured or even killed.

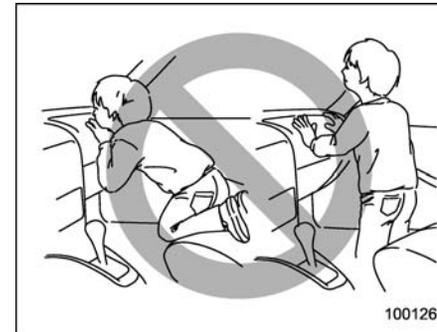

– CONTINUED –

WARNING

Children should be properly restrained at all times. Never allow a child to stand up, or to kneel on any seat. Unrestrained children will be thrown forward during sudden stop or in an accident and can be injured seriously.

Additionally, children standing up or kneeling on or in front of the front seat are exposed another serious danger. Since the SRS airbag deploys with considerable speed and force, the child could be injured or even killed.

Where to place a child restraint system

The following are SUBARU's recommendations on where to place a child restraint system in your vehicle.

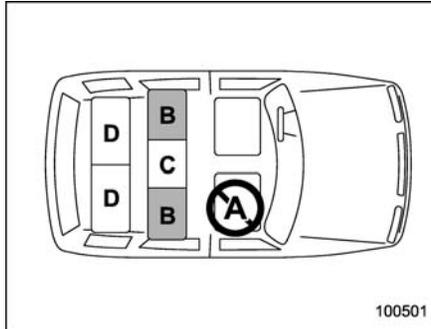

A: Front passenger's seat

You should not install a child restraint system (including a booster seat) due to the hazard to children posed by the passenger's airbag.

B: Rear outboard seats (5-seater models)/second-row outboard seats (7-seater models)

Recommended positions for all types of child restraint systems.

In these positions, Automatic/Emergency Locking Retractor (A/ELR) seatbelts and lower anchorages (bars) are provided for installing a child restraint system.

Some types of child restraints might not be able to be secured firmly due to projection of the seat cushion.

In this seating position, you should use

only a child restraint system that has a bottom base that fits snugly against the contours of the seat cushion and can be securely retained using the seatbelt.

C: Rear center seat (5-seater models)/second-row center seat (7-seater models)

Installing a child restraint system is not recommended, although the A/ELR seatbelt and an upper anchorage (tether anchorage) are provided in this position.

Some types of child restraints might not be able to be secured firmly due to projection of the seat cushion.

In this seating position, you should use only a child restraint system that has a bottom base that fits snugly against the contours of the seat cushion and can be securely retained using the seatbelt.

D: Third-row seat (7-seater models)

Installing a child restraint system is not recommended, although the A/ELR seatbelt and two upper anchorages (tether anchorages) are provided in these positions.

These seating positions are not equipped with lower anchorages (bars) for installing LATCH system-type child restraints. However, child restraint devices can be used in these position using the A/ELR seatbelts and upper anchorages (tether an-

chorage) provided.

Some types of child restraints might not be able to be secured firmly due to projection of the seat cushion.

In this seating position, you should use only a child restraint system that has a bottom base that fits snugly against the contours of the seat cushion and can be securely retained using the seatbelt.

▲ WARNING

Put children aged 12 and under in the rear seat properly restrained at all times. The SRS airbag deploys with considerable speed and force and can injure or even kill children, especially if they are 12 years of age and under and are not restrained or improperly restrained. Because children are lighter and weaker than adults, their risk of being injured from deployment is greater.

Consequently, be sure to secure ALL types of child restraint devices (including forward facing child seats) in the REAR seats at all times. You should choose a restraint device which is appropriate for the child's age, height and weight. According to accident statistics, children are safer when properly re-

strained in the rear seating positions than in the front seating positions.

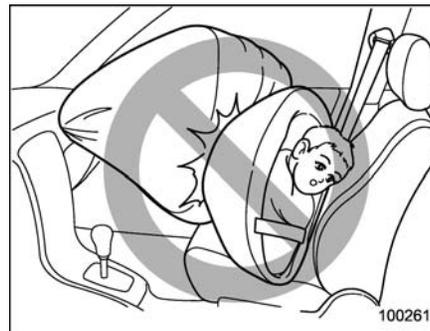

▲ WARNING

SINCE YOUR VEHICLE IS EQUIPPED WITH A PASSENGER'S SRS AIRBAG, DO NOT INSTALL A REARWARD FACING CHILD SAFETY SEAT IN THE FRONT PASSENGER'S SEAT. DOING SO RISKS SERIOUS INJURY OR DEATH TO THE CHILD BY PLACING THE CHILD'S HEAD TOO CLOSE TO THE SRS AIRBAG.

■ Choosing a child restraint system

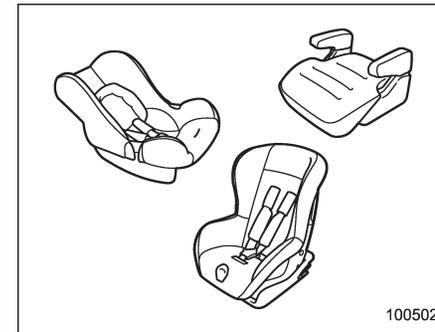

Choose a child restraint system that is appropriate for the child's age and size (weight and height) in order to provide the child with proper protection. The child restraint system should meet all applicable requirements of Federal Motor Vehicle Safety Standards for United States or Canada Motor Vehicle Safety Standards for Canada. It can be identified by looking for the label on the child restraint system or the manufacturer's statement of compliance in the document attached to the system. Also it is important for you to make sure that the child restraint system is compatible with the vehicle in which it will be used.

- CONTINUED -

■ Installing child restraint systems with A/ELR seatbelt

⚠ WARNING

- Child restraint systems and seatbelts can become hot in a vehicle that has been closed up in sunny weather; they could burn a small child. Check the child restraint system before you place a child in it.
- Do not leave an unsecured child restraint system in your vehicle. Unsecured child restraint systems can be thrown around inside of the vehicle in a sudden stop, turn or accident; they can strike and injure vehicle occupants as well as result in serious injuries or death to the child.

⚠ CAUTION

When you install a child restraint system, follow the manufacturer's instructions supplied with it. After installing the child restraint system, check to ensure that it is held securely in position. If it is not held tight and secure, the danger of your

child suffering personal injury in the event of an accident may be increased.

▼ Installing a rearward facing child restraint

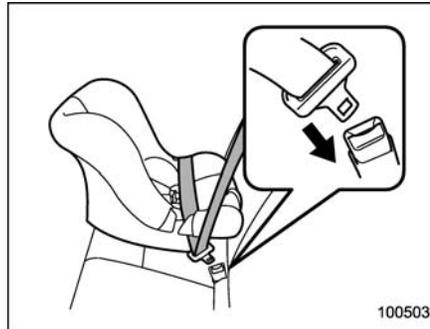

1. Slide the seat or seat pair to its rearmost position.
2. Adjust the seatback to the upright position.
3. Place the child restraint system in the rear seating position.
4. Run the lap and shoulder belt through or around the child restraint system following the instructions provided by its manufacturer.
5. Insert the tongue plate into the buckle until you hear a click.



6. Take up the slack in the lap belt.
7. Pull out the seatbelt fully from the retractor to change the retractor over from the Emergency Locking Retractor (ELR) to the Automatic Locking Retractor (ALR) function. Then, allow the belt to rewind into the retractor. As the belt is rewinding, clicks will be heard which indicate the retractor functions as ALR.

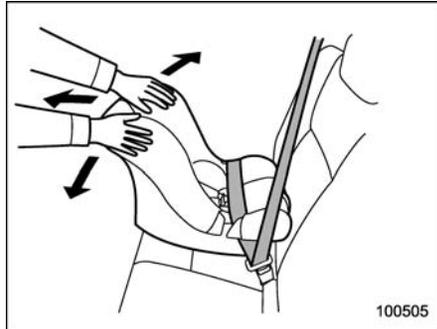

8. Push and pull the child restraint system forward and from side to side to check if it is firmly secured.

Sometimes a child restraint can be more firmly secured by pushing it down into the seat cushion and then tightening the seatbelt.

9. Pull at the shoulder portion of the belt to confirm that it cannot be pulled out (ALR properly functioning).

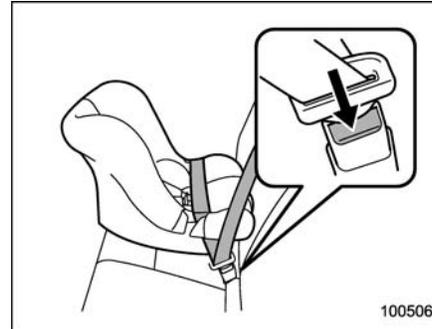

10. To remove the child restraint system, press the release button on the seatbelt buckle and allow the belt to retract completely. The belt will return to the ELR mode.

WARNING

NEVER INSTALL A REARWARD FACING CHILD SEAT IN THE FRONT PASSENGER'S SEAT. DOING SO RISKS SERIOUS INJURY OR DEATH TO THE CHILD BY PLACING THE CHILD'S HEAD TOO CLOSE TO THE SRS AIRBAG.

NOTE

When the child restraint system is no longer in use, remove it and restore the ELR function of the retractor. That function is restored by retracting the seatbelt fully.

▼ **Installing forward facing child restraint**

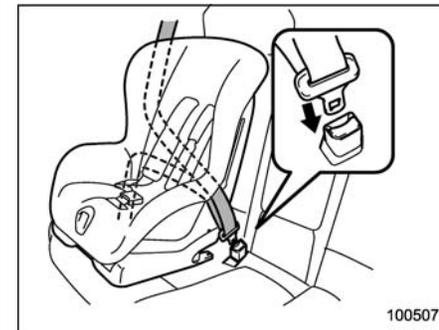

1. Slide the seat or seat pair to its rearmost position.
2. Adjust the seatback to the upright position.
3. Place the child restraint system in the seating position.
4. Run the lap and shoulder belt through or around the child restraint system following the instructions provided by its manufacturer.

– CONTINUED –

1-36 *Seat, seatbelt and SRS airbags*

5. Insert the tongue plate into the buckle until you hear a click.

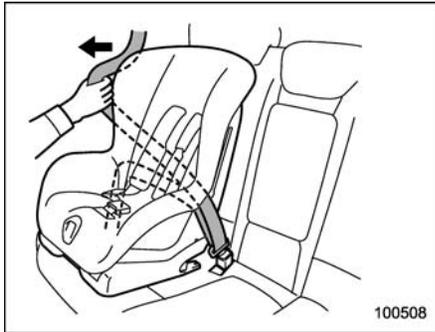

6. Take up the slack in the lap belt.

7. Pull out the seatbelt fully from the retractor to change the retractor over from the Emergency Locking Retractor (ELR) to the Automatic Locking Retractor (ALR) function. Then, allow the belt to rewind into the retractor. As the belt is rewinding, clicks will be heard which indicate the retractor functions as ALR.

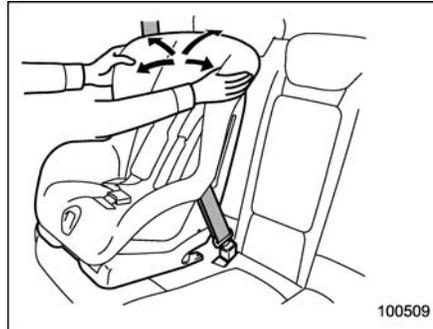

8. Before having a child sit in the child restraint system, move it back and forth and right and left to check if it is firmly secured. Sometimes a child restraint can be more firmly secured by pushing it down into the seat cushion and then tightening the seatbelt.

9. Pull at the shoulder portion of the belt to confirm that it cannot be pulled out (ALR properly functioning).

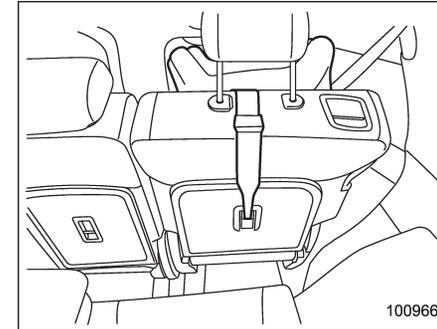

Rear seat (5-seater models)/Second-row seat (7-seater models)

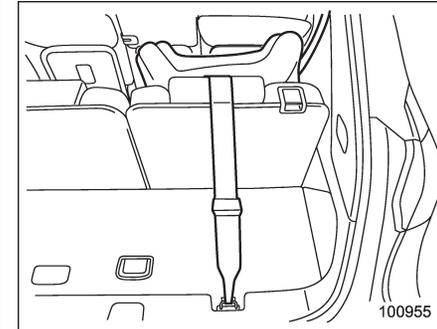

Third-row seat (7-seater models)

10. If the child restraint system requires a top tether, latch the hook onto the top tether anchor and tighten the top tether.

Refer to “Top tether anchorages” for additional instructions.

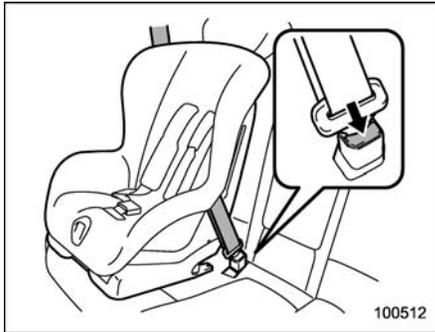

11. To remove the child restraint system, press the release button on the seatbelt buckle and allow the belt to retract completely. The belt will return to the ELR mode.

NOTE

When the child restraint system is no longer in use, remove it and restore the ELR function of the retractor. That function is restored by allowing the seatbelt to retract fully.

■ Installing a booster seat

⚠ WARNING

- Child restraint systems and seatbelts can become hot in a vehicle that has been closed up in sunny weather; they could burn a small child. Check the child restraint system before you place a child in it.
- Do not leave an unsecured child restraint system in your vehicle. Unsecured child restraint systems can be thrown around inside of the vehicle in a sudden stop, turn or accident; they can strike and injure vehicle occupants as well as result in serious injuries or death to the child.

⚠ CAUTION

When you install a child restraint system, follow the manufacturer’s instructions supplied with it. After installing the child restraint system, check to ensure that it is held securely in position. If it is not held tight and secure, the danger of your child suffering personal injury in the event of an accident may be in-

creased.



1. Slide the seat or seat pair to its rearmost position.
 2. Place the booster seat in the rear seating position and sit the child on it. The child should sit well back on the booster seat.
 3. Run the lap and shoulder belt through or around the booster seat and the child following the instructions provided by its manufacturer.
 4. Insert the tongue plate into the buckle until you hear a click. Take care not to twist the seatbelt.
- Make sure the shoulder belt is positioned across the center of child’s shoulder and that the lap belt is positioned as low as possible on the child’s hips.

– CONTINUED –

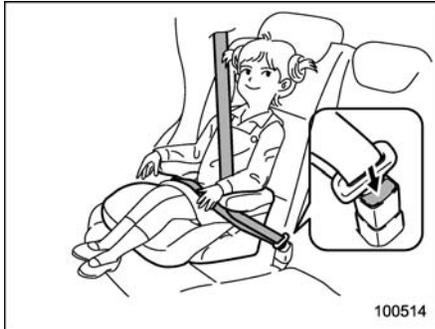

5. To remove the booster seat, press the release button on the seatbelt buckle and allow the belt to retract.

WARNING

- Never use a belt that is twisted or reversed. In an accident, this can increase the risk or severity of injury to the child.
- Never place the shoulder belt under the child's arm or behind the child's back. If an accident occurs, this can increase the risk or severity of injury to the child.
- The seatbelt should fit snugly in order to provide full restraint. Loose fitting belts are not as

effective in preventing or reducing injury.

- Place the lap belt as low as possible on the child's hips. A high-positioned lap belt will increase the risk of sliding under the lap belt and of the lap belt sliding up over the abdomen, and both can result in serious internal injury or death.
- Make sure the shoulder belt is positioned across the center of child's shoulder. Placing the shoulder belt over the neck may result in neck injury during sudden braking or in a collision.

Installation of child restraint systems by use of lower and tether anchorages (LATCH)

WARNING

- Child restraint systems and seatbelts can become hot in a vehicle that has been closed up in sunny weather; they could burn a small child. Check the child restraint system before you place a child in it.
- Do not leave an unsecured child

restraint system in your vehicle. Unsecured child restraint systems can be thrown around inside of the vehicle in a sudden stop, turn or accident; they can strike and injure vehicle occupants as well as result in serious injuries or death to the child.

CAUTION

When you install a child restraint system, follow the manufacturer's instructions supplied with it. After installing the child restraint system, check to ensure that it is held securely in position. If it is not held tight and secure, the danger of your child suffering personal injury in the event of an accident may be increased.

Some types of child restraint systems can be installed in a rear seating position of your vehicle without use of the seatbelts. Such child restraint systems are secured to the dedicated anchorages provided on the vehicle body.

The lower and tether anchorages are sometimes referred to as the LATCH system (Lower Anchors and Tethers for Children).

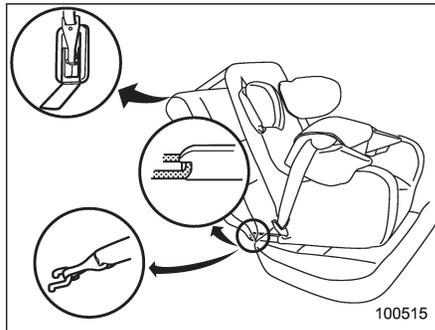
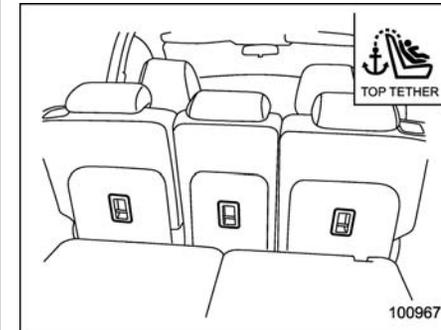
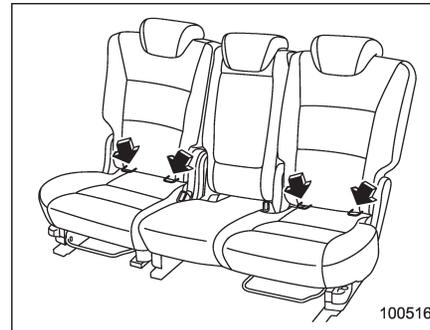

Lower anchorages for child restraints are provided in the following locations:

- 5-seater models: on the rear seats
- 7-seater models: on the second-row seats

For each window-side seating position, two lower anchorages are provided. Each lower anchorage is located where the seat cushion meets the seatback.

The tether anchorages (upper anchorages) are provided for all the seating positions of the rear seat (5-seater models)/second-row seat (7-seater models).

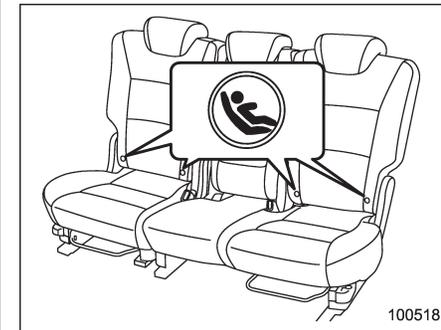

On each outboard rear/second-row seat, you will find marks "Ⓜ" at the bottom of the

Your vehicle is provided with child restraint system anchors as follows:

- Four lower anchorages (bars) and three upper anchorages (tether anchorages) on the rear seat (5-seater model)/second-row seat (7-seater model)

– CONTINUED –

1-40 Seat, seatbelt and SRS airbags

seatback.

Each lower anchorage is located where the seat cushion meets the seatback.

CAUTION

When you install a child restraint system, follow the manufacturer's instructions supplied with it. After installing the child restraint system, check to ensure that it is held securely in position. If it is not held tight and secure, the danger of your child suffering personal injury in the event of an accident may be increased.

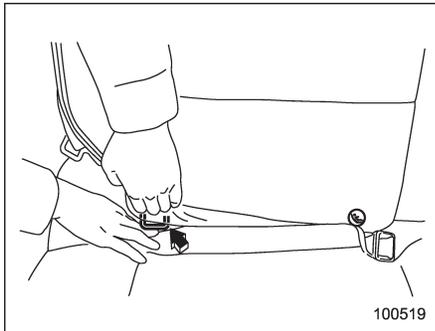

1. Slide the seat or seat pair to its rearmost position.

2. Make the clearance between the seat cushion and seatback a little wider to locate the two anchorages (bars) for the position where you want to install the child restraint system.

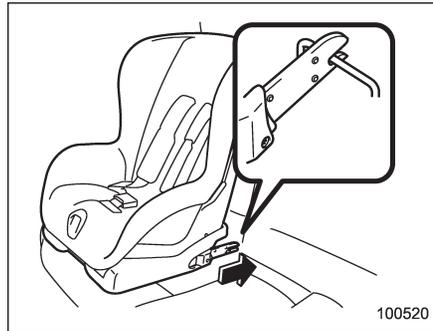

3. While following the instructions supplied by the child restraint system manufacturer, connect the lower hooks onto the lower anchorages located at "Ⓞ" marks on the bottom of the seatback. When the hooks are connected, make sure the adjacent seatbelts are not caught.



4. [If your child restraint system is of a flexible attachment type (which uses tether belts to connect the child restraint system properly to the lower anchorages)] While pushing the child restraint into the seat cushion, pull both left and right lower tether belts up to secure the child restraint system firmly by taking up the slack in the belt.

5. Connect the top tether hook to the tether anchorage and firmly tighten the tether.

For information on how to set the top tether, Refer to the following "Top tether anchorages" section.



6. Before seating a child in the child restraint system, try to move seat back and forth and left and right to verify that it is held securely in position.

7. To remove the child restraint system, follow the reverse procedures of installation.

If you have any question concerning this type of child restraint system, ask your SUBARU dealer.

■ Top tether anchorages

Your vehicle is equipped with three top tether anchorages (five in the 7-seater models) so that a child restraint system having a top tether can be installed in a rear seating position. When installing a child restraint system using top tether, proceed as follows, while observing the

instructions by the child restraint system manufacturer.

Since a top tether can provide additional stability by offering another connection between a child restraint system and the vehicle, we recommend that you use a top tether whenever one is required or available.

▼ Tether anchorage location

▽ Rear seat (5-seater models)/Second-row seat (7-seater models)

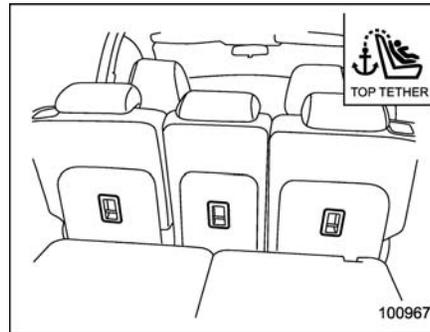

Three tether anchorages, i.e., ones for the right, center and left seats, are already installed on the back of each seatback. Open the cover flap to use each anchorage.

▽ Third-row seat (7-seater models)

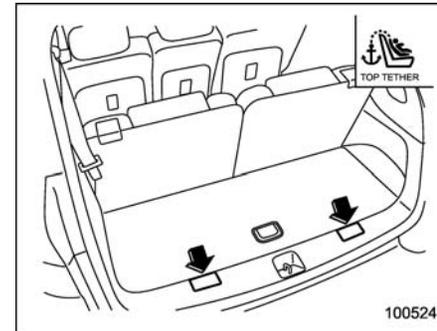

Two tether anchorages are attached to the rear edge of the cargo area.

Open the cover flap to use each anchorage.

▼ To hook the top tether

▽ Rear seat (5-seater models)/Second-row seat (7-seater models)

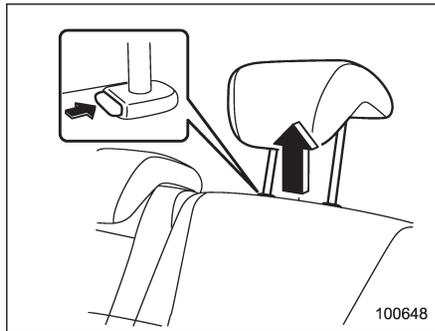

1. Raise the head restraint to the highest position at the seating position where the child seat has been installed using the seatbelt or lower anchorages; lift up the head restraint while pressing the release button.

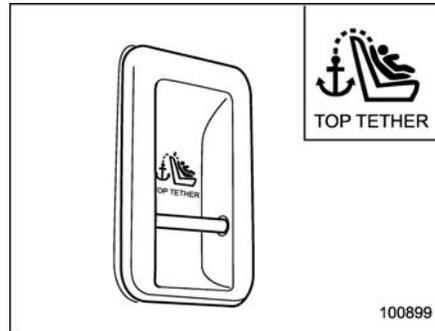

2. Confirm that there are no obstacles around the anchorages.

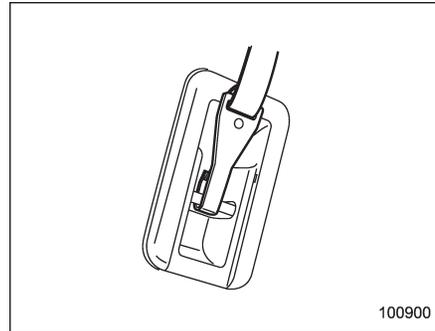

3. Fasten the top tether hook of the child restraint system to the appropriate upper anchorage.
4. Tighten the top tether securely.

CAUTION

When the child restraint system is to be secured using the top tether, pass the top tether under the head restraint between the head restraint stay posts.

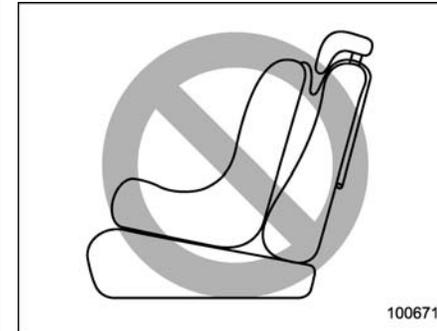

CAUTION

Be sure to install the top tether with the head restraint raised to the highest position. If the head restraint is in any of the lower positions, the top tether will touch the head restraint and the resulting slack will prevent its secure installation.

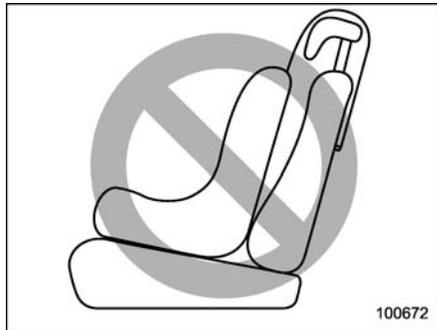

CAUTION

Do not route the top tether over the head restraint. It may happen that the top tether cannot be fastened tightly.

▽ Third-row seat (7-seater models)

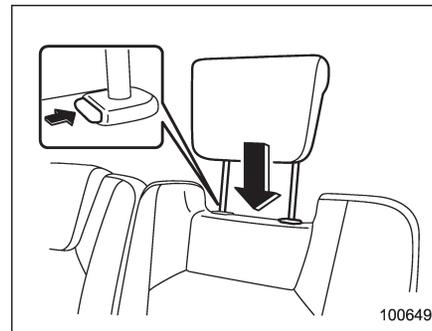

1. Lower the head restraint to its lowest position.

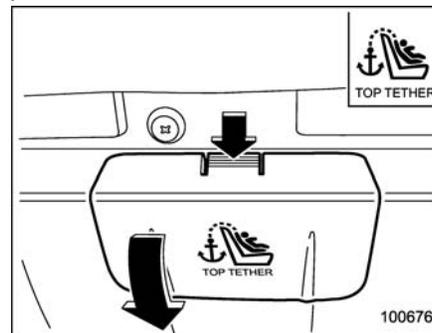

2. Open the lid of the cargo area, then remove the covers for the anchorages.

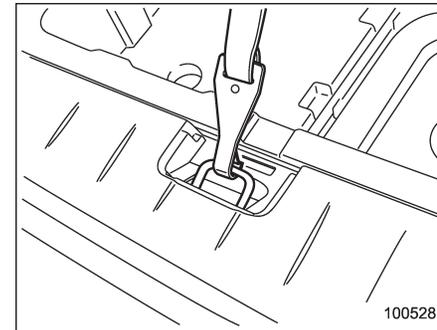

3. Fasten the top tether hook of the child restraint system to the appropriate upper anchorage.

4. Tighten the top tether securely.

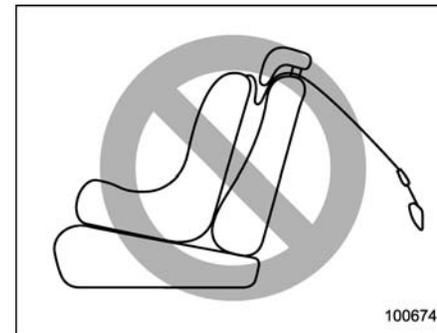

- CONTINUED -

CAUTION

Do not pass the top tether under the head restraint. The top tether will touch the head restraint and the resulting slack will prevent its secure installation.

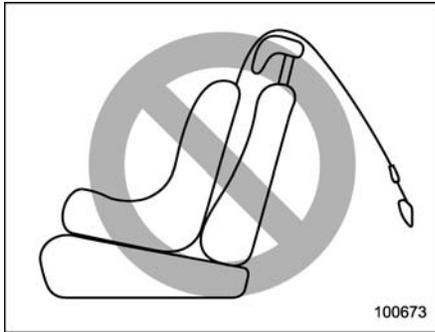

CAUTION

Do not use the top tether with the head restraint in a raised position, otherwise the top tether cannot be fastened tightly.

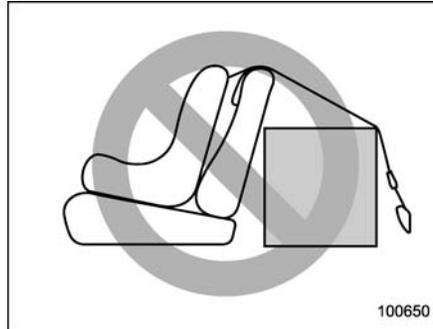

CAUTION

Prevent the top tether from touching cargo in the cargo area. The top tether may become slack if the cargo changes shape or moves.

***SRS airbag (Supplemental Restraint System airbag)**

*SRS: This stands for supplemental restraint system. This name is used because the airbag system supplements the vehicle's seatbelts.

Your vehicle is equipped with a crash sensing and diagnostic module, which will record the use of the seatbelt(s) by the driver and front passenger when any of the SRS frontal, side and curtain airbags deploy.

■ Your vehicle's SRS configuration

The driver's seat, the front passenger's seat, and the outboard seats of the rear/second seating row of your vehicle are each provided with, in addition to a lap/shoulder belt, one or more airbags as follows:

- Frontal airbag (one each for driver's seat and front passenger's seat)
- Side airbag (one each for driver's seat and front passenger's seat)
- Curtain airbag (one each for the outboard sides of cabin, extending from driver's and front passenger's seats to rear/second seating row)

These SRS airbags are designed only as a supplement to the primary protection provided by the seatbelt.

The system also controls front seatbelt pretensioners. For operation instructions and precautions concerning the seatbelt pretensioner, refer to the "Front seatbelt pretensioners" section in this chapter.



WARNING

- To obtain maximum protection in the event of an accident, the driver and all passengers in the vehicle should always wear seatbelts when the vehicle is moving. The SRS airbag is designed only as a supplement to the primary protection provided by the seatbelt. It does not do away with the need to fasten seatbelts. In combination with the seatbelts, it offers the best combined protection in case of a serious accident. Not wearing a seatbelt increases the chance of severe injury or death in a crash even when the vehicle has the SRS airbag. For instructions and precautions concerning the seatbelt system, refer to the "Seatbelts" section in this chapter.

- Do not sit or lean unnecessarily close to the SRS airbag. Because the SRS airbag deploys with considerable speed – faster than the blink of an eye – and force to protect in high speed collisions, the force of an airbag can injure an occupant whose body is too close to SRS airbag.

It is also important to wear your seatbelt to help avoid injuries that can result when the SRS airbag contacts an occupant not in proper position such as one thrown forward during pre-accident braking.

Even when properly positioned, there remains a possibility that an occupant may suffer minor injury such as abrasions and bruises to the face or arms because of the SRS airbag deployment force.

- The SRS airbags deploy with considerable speed and force. Occupants who are out of proper position when the SRS airbag deploys could suffer very serious injuries. Because the SRS airbag needs enough space for deployment, the driver should always sit upright and well back in the

seat as far from the steering wheel as practical while still maintaining full vehicle control and the front passenger should move the seat as far back as possible and sit upright and well back in the seat.

- Do not place any objects over or near the SRS airbag cover or between you and the SRS airbag. If the SRS airbag deploys, those objects could interfere with its proper operation and could be propelled inside the vehicle and cause injury.



100350

– CONTINUED –

 **WARNING**

- Put children aged 12 and under in a rear seat properly restrained at all times. The SRS airbag deploys with considerable speed and force and can injure or even kill children, especially if they are 12 years of age and under and are not restrained or improperly restrained. Because children are lighter and weaker than adults, their risk of being injured from deployment is greater.

Consequently, we strongly recommend that ALL children (including those in child seats and those that have outgrown child restraint devices) sit in a REAR seat properly restrained at all times in a child restraint device or in a seatbelt, whichever is appropriate for the child's age, height and weight.

Always secure ALL types of child restraint devices (including forward facing child seats) in one of the rear seating positions recommended in this Owner's Manual.

According to accident statistics, children are safer when properly

restrained in the rear seating positions than in the front seating positions.

For instructions and precautions concerning the child restraint system, refer to the "Child restraint systems" section in this chapter.

- NEVER INSTALL A REARWARD FACING CHILD SEAT IN THE FRONT SEAT. DOING SO RISKS SERIOUS INJURY OR DEATH TO THE CHILD BY PLACING THE CHILD'S HEAD TOO CLOSE TO THE SRS AIRBAG.
- Never allow a child to stand up, or to kneel on the front passenger's seat, or never hold a child on your lap or in your arms. The SRS airbag deploys with considerable force and can injure or even kill the child.

 **CAUTION**

- When the SRS airbag deploys, some smoke will be released. This smoke could cause breathing problems for people with a history of asthma or other breathing trouble. If you or your

passengers have breathing problems after SRS airbag deploys, get fresh air promptly.

- A deploying SRS airbag releases hot gas. Occupants could get burned if they come into direct contact with the hot gas.

NOTE

When you sell your vehicle, we urge you to explain to the buyer that it is equipped with SRS airbags by alerting him or her to the applicable section in this Owner's Manual.

▼ Components

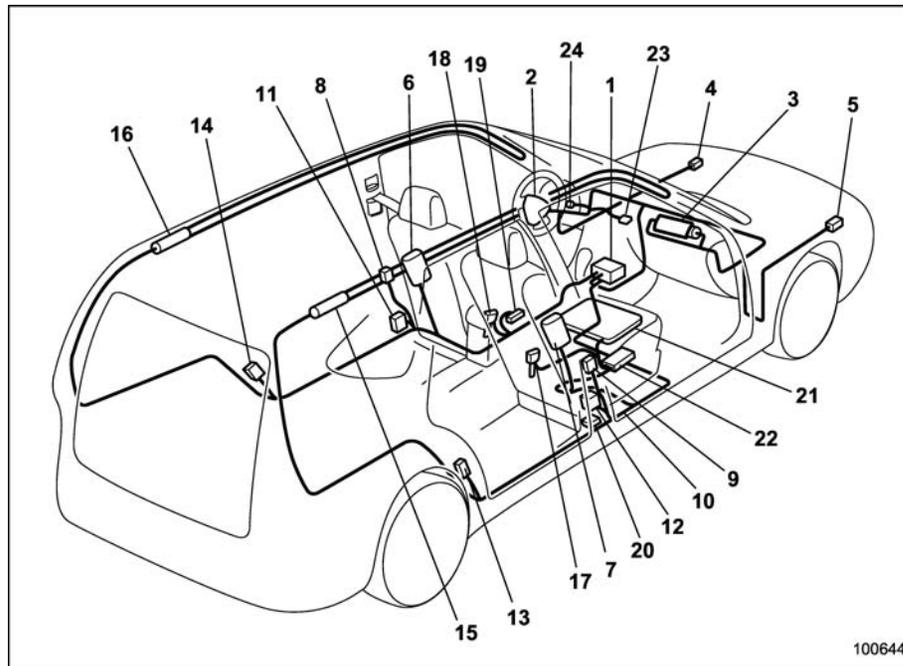

- | | |
|--|--|
| 1) Airbag control module (including impact and rollover sensors) | 5) Front sub sensor (right-hand side) |
| 2) Frontal airbag module (driver's side) | 6) Side airbag module (driver's side) |
| 3) Frontal airbag module (front passenger's side) | 7) Side airbag module (front passenger's side) |
| 4) Front sub sensor (left-hand side) | 8) Side airbag sensor (center pillar left-hand side) |

- | |
|---|
| 9) Side airbag sensor (center pillar right-hand side) |
| 10) Airbag wiring |
| 11) Seatbelt pretensioner (driver's side) |
| 12) Seatbelt pretensioner (front passenger's side) |
| 13) Curtain airbag sensor (rear wheel house right-hand side) |
| 14) Curtain airbag sensor (rear wheel house left-hand side) |
| 15) Curtain airbag module (right side) |
| 16) Curtain airbag module (left side) |
| 17) Seatbelt buckle switch (front passenger's side) |
| 18) Seatbelt buckle switch (driver's side) |
| 19) Driver's seat position sensor |
| 20) Front passenger's seatbelt tension sensor |
| 21) Front passenger's occupant detection system weight sensor |
| 22) Front passenger's occupant detection control module |
| 23) Front passenger's frontal airbag ON and OFF indicator |
| 24) SRS airbag system warning light |

– CONTINUED –

■ **SUBARU advanced frontal airbag system**

Your vehicle is equipped with a SUBARU advanced frontal airbag system that complies with the new advanced frontal airbag requirements in the amended Federal Motor Vehicle Safety Standard (FMVSS) No. 208.

The SUBARU advanced frontal airbag system automatically determines the deployment force of the driver's SRS frontal airbag at the time of deployment as well as whether or not to activate the front passenger's SRS frontal airbag and, if activated, the deployment force of the SRS frontal airbag at the time of deployment.

Your vehicle has warning labels on the driver's and front passenger's sun visors beginning with the phrase "EVEN WITH ADVANCED AIR BAGS" and a tag attached to the glove box lid beginning with the phrase "Even with Advanced Air Bags". Make sure that you carefully read the instructions on the warning labels and tag.

Always wear your seatbelt. The SUBARU advanced frontal airbag system is a supplemental restraint system and must be used in combination with a seatbelt. All occupants should wear a seatbelt or be seated in an appropriate child restraint

system.

The driver's SRS frontal airbag is stowed in the center portion of the steering wheel. The front passenger's SRS frontal airbag is stowed near the top of the dashboard under an "SRS AIRBAG" mark.

In a moderate to severe frontal collision, the driver's and front passenger's SRS frontal airbags deploy and supplement the seatbelts by reducing the impact on the driver's and front passenger's head and chest.

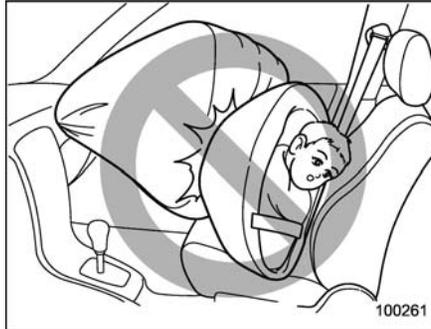

⚠ WARNING

NEVER INSTALL A REARWARD FACING CHILD SAFETY SEAT IN THE FRONT SEAT. DOING SO RISKS SERIOUS INJURY OR DEATH TO

THE CHILD BY PLACING THE CHILD'S HEAD TOO CLOSE TO THE SRS AIRBAG.

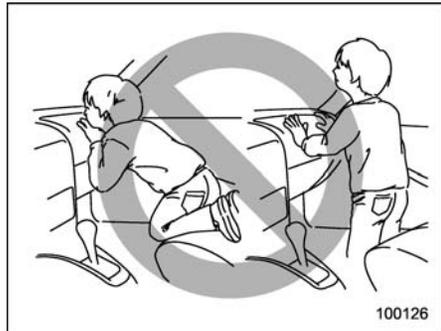

⚠ WARNING

Never allow a child to stand up, or to kneel on the front passenger's seat. The SRS airbag deploys with considerable force and can injure or even kill the child.



⚠ WARNING

Never hold a child on your lap or in your arms. The SRS airbag deploys with considerable force and can injure or even kill the child.



⚠ WARNING

The SRS airbag deploys with considerable speed and force. Occupants who are out of proper position when the SRS airbag deploys could suffer very serious injuries. Because the SRS airbag needs enough space for deployment, the driver should always sit upright and well back in the seat as far from the steering wheel as practical while still maintaining full vehicle control and the front passenger should move the seat as far back as possible and sit upright and well back in the seat.

It is also important to wear your

seatbelt to help avoid injuries that can result when the SRS airbag contacts an occupant not in proper position such as one thrown toward the front of the vehicle during pre-accident braking.

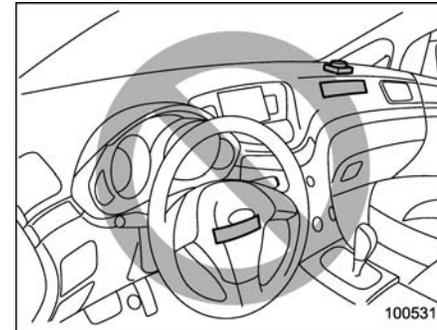

⚠ WARNING

Do not put any objects over the steering wheel pad and dashboard. If the SRS frontal airbag deploys, those objects could interfere with its proper operation and could be propelled inside the vehicle and cause injury.

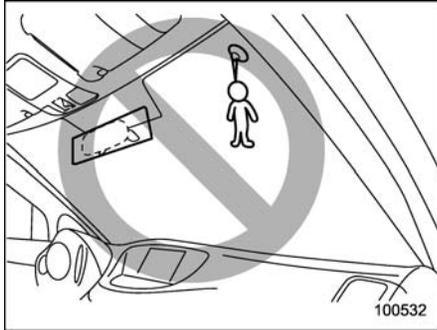

WARNING

Do not attach accessories to the windshield, or fit an extra-wide mirror over the rear view mirror. If the SRS airbag deploys, those objects could become projectiles that could seriously injure vehicle occupants.

▼ **Driver's SRS frontal airbag**

The driver's SRS frontal airbag uses a dual stage inflator. The inflator operates in different ways depending on the severity of impact, backward-forward adjustment of the driver's seat position and whether or not he/she is wearing the seatbelt.

The backward-forward adjustment of the driver's seat position is monitored by the

driver's seat position sensor under the driver's seat.

Whether or not the driver is wearing the seatbelt is monitored by the seatbelt buckle switch.

Observe the following precautions. Failure to do so may cause the seatbelt buckle switch and/or the seat position sensor to malfunction, preventing the SUBARU advanced frontal airbag system from functioning correctly or causing the system to fail.

- Do not place articles/metal objects or install any accessory other than a genuine SUBARU accessory under the driver's seat. Do not allow the rear seat occupant to kick the driver's seat or push up its bottom surface with his/her feet.
- Do not place a magnet near the seatbelt buckle or under the driver's seat.

If the seatbelt buckle switch and/or the driver's seat position sensor have failed, the SRS airbag system warning light will illuminate. Although the driver's SRS frontal airbag can deploy regardless of the backward-forward adjustment of the driver's seat position even when the warning light illuminates, have the system inspected by your SUBARU dealer immediately if the SRS airbag system warning light illuminates.

NOTE

The driver's SRS side airbag, SRS curtain airbag and seatbelt pretensioner are not controlled by the SUBARU advanced frontal airbag system.

▼ **Front passenger's SRS frontal airbag**

The front passenger's SRS frontal airbag uses a dual stage inflator. The inflator operates in different ways depending on the severity of impact.

The total load on the seat is monitored by the occupant detection system's weight sensor located under the seat.

The system has another sensor that monitors the tension of the front passenger seatbelt. Using the total seat load and seatbelt tension data from the sensors, the occupant detection system determines whether the front passenger's SRS frontal airbag should or should not be inflated.

The occupant detection system may not inflate the front passenger's SRS frontal airbag even when the driver's SRS frontal airbag deploys. This is normal.

Observe the following precautions. Failure to do so may prevent the SUBARU advanced frontal airbag system from functioning correctly or cause the system to fail.

- Do not apply any strong impact to the front passenger's seat such as by kicking.
- Do not spill liquid on the front passenger's seat. If liquid is spilled, wipe it off immediately.
- Do not remove or disassemble the front passenger's seat.
- Do not install any accessory (such as an audio amplifier) other than a genuine SUBARU accessory under the front passenger's seat.
- Do not place anything (shoes, umbrella, etc.) under the front passenger's seat.
- The front passenger's seat must not be used with the head restraint removed.
- Do not leave any article including a child restraint system on the front passenger's seat or the seatbelt tongue and buckle engaged when you leave your vehicle.
- Do not place a magnet near the seatbelt buckle and the seatbelt retractor.

If the seatbelt buckle switch and/or front passenger's occupant detection system have failed, the SRS airbag system warning light will illuminate. Have the system inspected by your SUBARU dealer immediately if the SRS airbag system warning light illuminates.

If your vehicle has sustained impact, this may affect the proper function of the

SUBARU advanced frontal airbag system. Have your vehicle inspected at your SUBARU dealer.

NOTE

The front passenger's SRS side airbag, SRS curtain airbag and seatbelt pretensioner are not controlled by the SUBARU advanced frontal airbag system.

▼ **Passenger's frontal airbag ON and OFF indicators**

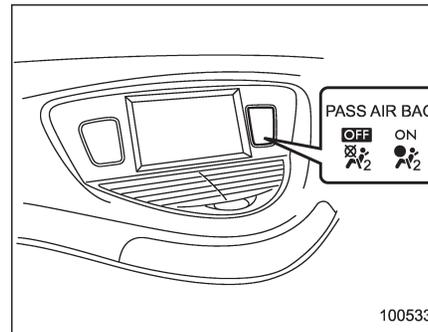

-  Front passenger's frontal airbag ON indicator
-  Front passenger's frontal airbag OFF indicator

The front passenger's frontal airbag ON and OFF indicators show you the status of

the front passenger's SRS frontal airbag. The indicators are located in the center portion of the instrument panel.

When the ignition switch is turned to the "ON" position, both the ON and OFF indicators illuminate for 6 seconds during which time the system is checked. Following the system check, both indicators turn off for 2 seconds. After that, one of the indicators illuminates depending on the status of the front passenger's SRS frontal airbag determined by the SUBARU advanced frontal airbag system monitoring.

If the front passenger's SRS frontal airbag is activated, the passenger's frontal airbag ON indicator will illuminate while the OFF indicator will remain off.

If the front passenger's SRS frontal airbag is deactivated, the passenger's frontal airbag ON indicator will remain off while the OFF indicator will illuminate.

With the ignition switch turned to the "ON" position, if both the ON and OFF indicators simultaneously remain illuminated or off even after the system check period, the system is malfunctioning. Contact your SUBARU dealer immediately for an inspection.

▼ **Conditions in which front passenger's SRS frontal airbag is not activated**

The front passenger's SRS frontal airbag will not be activated when any of the following conditions are met regarding the front passenger's seat:

- The seat is empty.
- The seat is equipped with a rearward facing child restraint system and an infant is restrained with it. (See WARNING that follows.)
- The seat is equipped with a forward facing child restraint system and a small child is restrained with it. (See WARNING that follows.)
- The seat is equipped with a booster seat and a small child is in the booster seat. (See WARNING that follows.)
- The seat is relieved of the occupant load for a time exceeding the predetermined monitoring time period.
- The seat is occupied by a child who has outgrown a child restraint system (See WARNING that follows.) or by a small adult.
- The front passenger's occupant detection system is malfunctioning.

 **WARNING**

NEVER INSTALL A REARWARD FACING CHILD SEAT IN THE FRONT PASSENGER'S SEAT EVEN IF THE FRONT PASSENGER'S SRS FRONTAL AIRBAG IS DEACTIVATED. Be sure to install it in one of the rear seating positions recommended in this Owner's Manual in a correct manner. Also, it is strongly recommended that any forward facing child seat or booster seat be installed in one of the rear seating positions recommended in this Owner's Manual, and that even children who have outgrown a child restraint system be also seated in a REAR seat. This is because children sitting in the front passenger's seat may be killed or severely injured should the front passenger's SRS frontal airbag deploy. REAR seats are the safest place for children.

When the front passenger's seat is occupied by a child, observe the following precautions. Failure to do so may increase the load on the front passenger's seat, activating the front passenger's SRS frontal airbag even though that seat is occupied by a child.

- Do not place any article on the seat other than the child occupant and a child restraint system.
- Do not place more than one child on the seat.
- Do not install any accessory such as a table or TV onto the seatback.
- Do not store a heavy load in the seatback pocket.
- Do not allow the rear/second-row seat occupant to place his/her hands or legs on the front passenger's seatback, or allow him/her to pull the seatback.

▽ **If the front passenger's frontal airbag ON indicator illuminates and the OFF indicator turns off even when an infant or a small child is in a child restraint system (including booster seat)**

Turn the ignition switch to the "LOCK" position if the front passenger's frontal airbag ON indicator illuminates and the OFF indicator turns off even when an infant or a small child is in a child restraint system (including booster seat). Remove the child restraint system from the seat. By referring to the child restraint manufacturer's recommendations as well as the child restraint system installation procedures in the "Child restraint systems" section in this chapter, correctly install

the child restraint system. Turn the ignition switch to the "ON" position and make sure that the front passenger's frontal airbag ON indicator turns off and the OFF indicator illuminates.

If the ON indicator still remains illuminated while the OFF indicator turns off, take the following actions.

- Ensure that no article is placed on the seat other than the child restraint system and the child occupant.
- Ensure that there is no article left in the seatback pocket.

If the ON indicator still remains illuminated while the OFF indicator turns off after taking relevant corrective actions described above, relocate the child restraint system to one of the rear seating positions recommended in this Owner's Manual and immediately contact your SUBARU dealer for an inspection.

NOTE

When a child who has outgrown a child restraint system or a small adult is seated in the front passenger's seat, the SUBARU advanced frontal airbag system may or may not activate the front passenger's SRS frontal airbag depending on the occupant's seating posture. If the front passenger's SRS

frontal airbag is activated (the ON indicator remains illuminated while the OFF indicator turns off), take the following actions.

- **Ensure that no article is placed on the seat other than the occupant.**
- **Ensure that there is no article left in the seatback pocket.**

If the ON indicator still remains illuminated while the OFF indicator turns off despite the fact that the actions noted above have been taken, seat the child/small adult in the rear seat and immediately contact your SUBARU dealer for an inspection. Even if the system has passed the dealer inspection, it is recommended that on subsequent trips the child/small adult always take the rear seat.

Children who have outgrown a child restraint system should always wear the seatbelt irrespective of whether the airbag is deactivated or activated.

▼ Conditions in which front passenger's SRS frontal airbag is activated

The front passenger's SRS frontal airbag will be activated for deployment upon impact when any of the following conditions is met regarding the front passenger's seat.

- When the seat is occupied by an adult.

- When a heavy article is placed on the seat.

When the front passenger's seat is occupied by an adult, observe the following precautions. Failure to do so may lessen the load on the front passenger's seat, deactivating the front passenger's SRS frontal airbag despite the fact that the seat is occupied by an adult.

- Do not allow the rear seat occupant to lift the front passenger's seat cushion using his/her feet.
- Do not place any article under the front passenger's seat, or squeeze any article from behind and under the seat. This may lift the seat cushion.
- Do not squeeze any article between the front passenger's seat and side trim/pillar, door or center console box. This may lift the seat cushion.

▽ If the passenger's frontal airbag OFF indicator illuminates and the ON indicator turns off even when the front passenger's seat is occupied by an adult

This can be caused by the adult incorrectly sitting in the front passenger's seat. Turn the ignition switch to the "LOCK" position. Ask the front passenger to set the seatback to the upright position, sit up

– CONTINUED –

1-54 Seat, seatbelt and SRS airbags

straight in the center of the seat cushion, correctly fasten the seatbelt, position his/her legs out forward, and adjust the seat to the rearmost position. Turn the ignition switch to the "ON" position. If the OFF indicator remains illuminated while the ON indicator remains off, take the following actions.

- Turn the ignition switch to the "LOCK" position.
- Ensure that there are no articles, books, shoes, or other objects trapped under the seat, at the rear of the seat, or on the side of the seat.
- Next, turn the ignition switch to the "ON" position and wait 6 seconds to allow the system to complete self-checking. Following the system check, both indicators turn off for 2 seconds. Now, the ON indicator should illuminate while the OFF indicator remains off.

If the OFF indicator still remains illuminated while the ON indicator remains off, ask the occupant to move to the rear seat and immediately contact your SUBARU dealer for an inspection.

▼ **Effect vehicle modifications made for persons with disabilities may have on SUBARU advanced frontal airbag system operation (U.S. only)**

Changing or moving any parts of the front

seats, seatbelts, front bumper, front side frame, instrument panel, combination meter, steering wheel, steering column, tire, suspension or floor panel can affect the operation of the SUBARU advanced airbag system. If you have any questions, you may contact the following SUBARU distributors:

<Continental U.S., Alaska and the District of Columbia>

Subaru of America, Inc.

Customer Dealer Services Department
P.O. Box 6000

Cherry Hill, NJ 08034-6000

1-800-SUBARU3 (1-800-782-2783)

<Hawaii>

Servco Subaru Inc., dba Subaru Hawaii
2850 Pukoloa Street, Suite 202, Honolulu,
HI 96819

808-839-2273

<Puerto Rico>

Trebol Motors

P.O. Box 11204, San Juan, Puerto Rico
00910

787-793-2828

There are currently no SUBARU distributors in any other U.S. territories. If you are in such an area, please contact the SUBARU distributor or dealer from which

you bought your vehicle.

▼ **Operation**

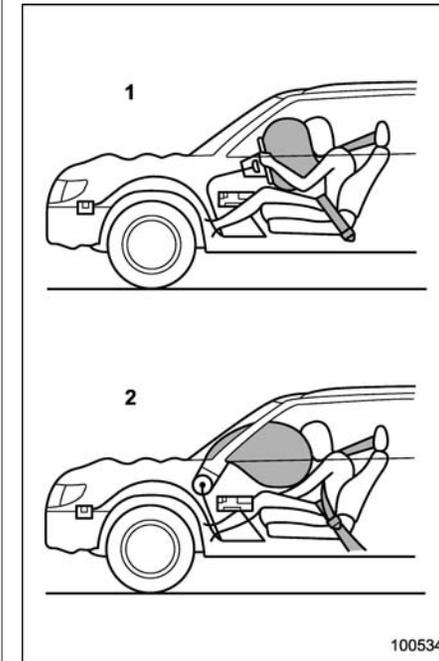

- 1) Driver's side
- 2) Passenger's side

The SRS airbag can function only when the ignition switch is in the "ON" position.

The SUBARU advanced frontal airbag system is designed to determine the activation or deactivation condition of the front passenger's SRS frontal airbag depending on the total load on the front passenger's seat monitored by the front passenger's occupant detection system weight sensor. For this reason, only the driver's SRS frontal airbag may deploy in the event of a collision, but this does not mean failure of the system.

If the front sub sensors located on both sides of the radiator panel and the impact sensors in the airbag control module detect a predetermined amount of force during a frontal collision, the control module sends signals to the airbag module(s) (only driver's module or both driver's and front passenger's modules) instructing the module(s) to inflate the SRS frontal airbag(s). The driver's and front passenger's SRS frontal airbags use dual stage inflators. The two inflators of each airbag are triggered either sequentially or simultaneously, depending on the severity of impact, backward-forward adjustment of the driver's seat position and fastening/unfastening of the seatbelt in the case of the driver's SRS frontal airbag and depending on the severity of impact and the total load on the seat in the case of the front passenger's SRS frontal airbag.

After deployment, the SRS airbag immediately starts to deflate so that the driver's vision is not obstructed. The time required from detecting impact to the deflation of the SRS airbag after deployment is shorter than the blink of an eye.

When only the driver's SRS frontal airbag deploys and both the driver's and front passenger's SRS frontal airbags deploy, the driver's and front passenger's seatbelt pretensioners operate at the same time.

Although it is highly unlikely that the SRS airbag would activate in a non-accident situation, should it occur, the SRS airbag will deflate quickly, not obscuring vision and will not interfere with the driver's ability to maintain control of the vehicle.

When the SRS airbag deploys, a sudden, fairly loud inflation noise will be heard and some smoke will be released. These occurrences are a normal result of the deployment. This smoke does not indicate a fire in the vehicle.

 **CAUTION**

Do not touch the SRS airbag system components around the steering wheel and dashboard with bare hands right after deployment. Doing so can cause burns because the

components can be very hot as a result of deployment.

The driver's SRS frontal airbag and front passenger's SRS frontal airbag are designed to deploy in the event of an accident involving a moderate to severe frontal collision. It is basically not designed to deploy in lesser frontal impacts because the necessary protection can be achieved by the seatbelt alone. Also, they are basically not designed to deploy in side or rear impacts or in rollover accidents because deployment of only the driver's SRS frontal airbag or both driver's and front passenger's SRS frontal airbags would not help the occupant in those situations. The driver's and front passenger's SRS frontal airbags are designed to function on a one-time-only basis.

SRS airbag deployment depends on the level of force experienced in the passenger compartment during a collision. That level differs from one type of collision to another, and it may have no bearing on the visible damage done to the vehicle itself.

– CONTINUED –

- ▽ **Examples of accidents in which the driver's/driver's and front passenger's SRS frontal airbag(s) will most likely deploy.**

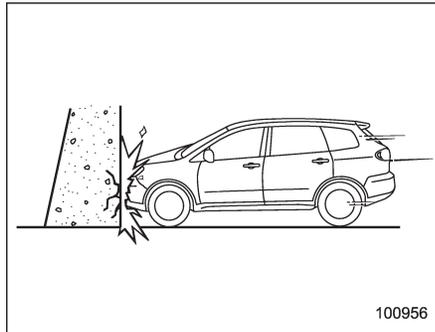

A head-on collision against a thick concrete wall at a vehicle speed of 12 to 19 mph (20 to 30 km/h) or higher activates only the driver's SRS frontal airbag or both driver's and front passenger's SRS frontal airbags. The airbag(s) will also be activated when the vehicle is exposed to a frontal impact similar in fashion and magnitude to the collision described above.

- ▽ **Examples of the types of accidents in which it is possible that the driver's/driver's and front passenger's SRS frontal airbag(s) will deploy.**

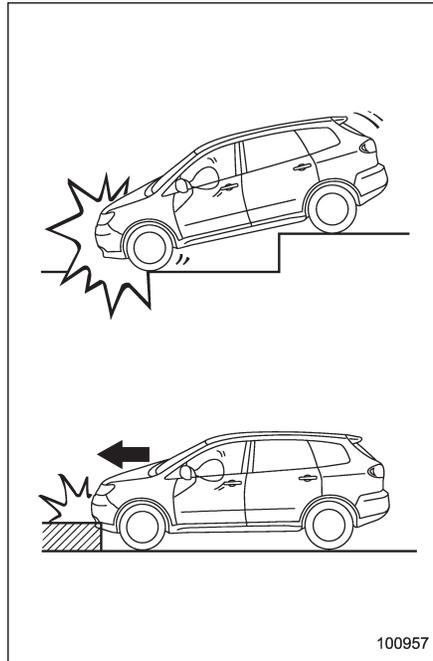

The only the driver's SRS frontal airbag or

both driver's and front passenger's SRS frontal airbags may be activated when the vehicle sustains a hard impact in the undercarriage area from the road surface (such as when the vehicle plunges into a deep ditch, is severely impacted or knocked hard against an obstacle on the road such as a curb).

▽ **Examples of the types of accidents in which deployment of the driver's/driver's and front passenger's SRS frontal airbag(s) is unlikely to occur.**

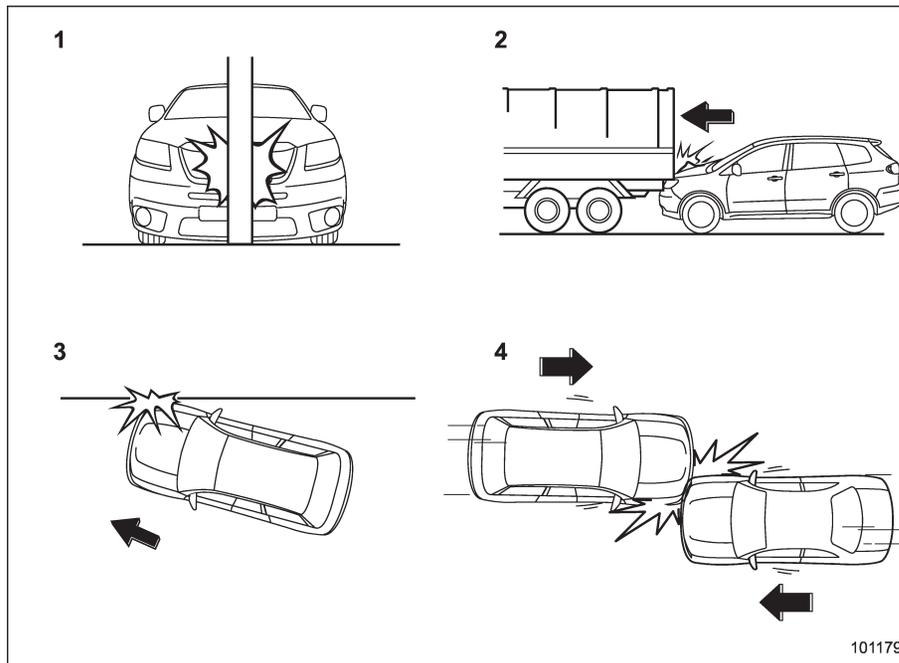

- 1) The vehicle strikes an object, such as a telephone pole or sign pole.
- 2) The vehicle slides under the load bed of a truck.
- 3) The vehicle sustains an oblique offset frontal impact.
- 4) The vehicle sustains an offset frontal collision.

There are many types of collisions which might not necessarily require deployment of driver's/driver's and front passenger's SRS frontal airbag(s). In the event of accidents like those illustrated, the driver's/driver's and front passenger's SRS frontal airbag(s) may not deploy depending on the level of accident forces involved.

▽ Examples of the types of accidents in which the driver's/driver's and front passenger's SRS frontal airbag(s) will basically not deploy.

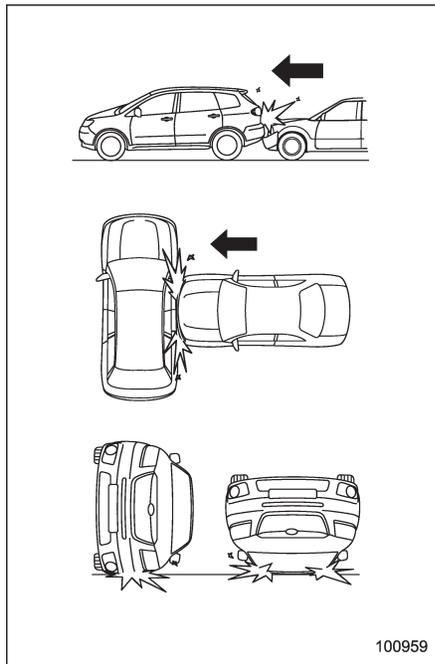

The driver's and front passenger's SRS frontal airbags are designed basically not

to deploy if the vehicle is struck from the side or from behind, or if it rolls onto its side or roof, or if it is involved in a low-speed frontal collision.

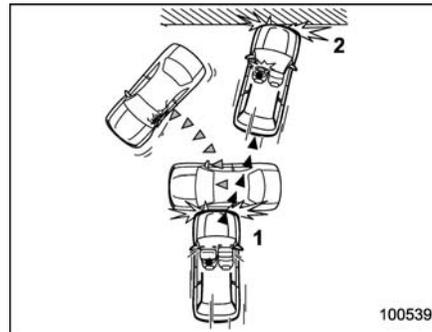

- 1) First impact
- 2) Second impact

In an accident where the vehicle is impacted more than once, the driver's and/or front passenger's SRS frontal airbag(s) will deploy only once on the first impact.

Example: In the case of a double collision, first with another vehicle, then against a concrete wall in immediate succession, once either or both of the driver's and front passenger's SRS frontal airbags is/are activated on the first impact, it/they will not be activated on the second impact.

■ SRS side airbag and SRS curtain airbag

The SRS side airbag is stored in the door side of each front seat seatback, which bears an "SRS AIRBAG" label.

In a moderate to severe side impact collision, the SRS side airbag on the impacted side of the vehicle deploys between the occupant and the door panel and supplements the seatbelt by reducing the impact to the occupant's chest and waist. The SRS side airbag operates only for front seat occupants.

The SRS curtain airbag on each side of the cabin is stored in the roof side (between the front pillar and a point over the rear seat). An "SRS AIRBAG" mark is located at the top of each center pillar.

In a moderate to severe side impact collision, the SRS curtain airbag on the impacted side of the vehicle deploys between the occupant and the side window and supplements the seatbelt by reducing the impact on the occupant's head.

In a rollover, SRS curtain airbags on both sides of the vehicle deploy between the occupant and the side window and supplement the seatbelt by reducing the impact to the occupant's head.

In a 7-seater model vehicle, the SRS

curtain airbag does not operate for third-row seat occupants.

⚠ WARNING

The SRS side airbag and SRS curtain airbag are designed as only a supplement to the primary protection provided by the seatbelt. They do not do away with the need to fasten seatbelts. It is also important to wear your seatbelt to help avoid injuries that can result when an occupant is not seated in a proper upright position.



⚠ WARNING

- Do not sit or lean unnecessarily

close to either front door. The SRS side airbag is stored in both front seat seatbacks next to the door, and it provides protection by deploying rapidly (faster than the blink of an eye) in the event of a side impact collision. However, the force of SRS side airbag deployment may cause injuries if your head or other parts of the body are too close to the SRS side airbag.

- Since your vehicle is equipped with SRS curtain airbags, do not sit or lean unnecessarily close to the front or rear door on either side. Also, do not put your head, arms and hands out of the window. The SRS curtain airbag on each side of the cabin is stored in the roof side (between the front pillar and a point over the rear seat), and it provides protection by deploying rapidly (faster than the blink of an eye) in the event of a side impact or a rollover. However, the force of its deployment may cause injuries if your head is too close to it.



⚠ WARNING

Do not rest your arm on either front door or its internal trim. It could be injured in the event of SRS side airbag deployment.

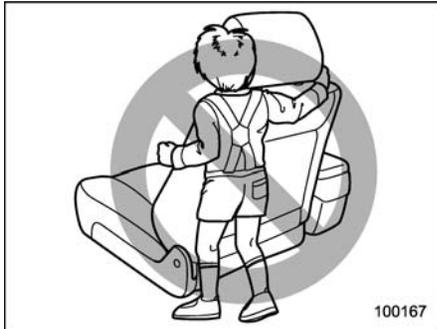

⚠ WARNING

- Never allow a child to kneel on the front passenger's seat facing the side window or to wrap his/her arms around the front seat

seatback. In the event of an accident, the force of the SRS side airbag deployment could injure the child seriously because his/her head or arms or other parts of the body are too close to the SRS side airbag.

Since your vehicle is also equipped with a front passenger's SRS frontal airbag, children aged 12 and under should be placed in a rear seat anyway and should be properly restrained at all times.

- Never allow a child to kneel on any passenger's seat facing the side window or put their head, arms and hands out of the window. In the event of an accident, the force of the SRS curtain airbag deployment could injure the child seriously because his/her head is close to the SRS curtain airbag.

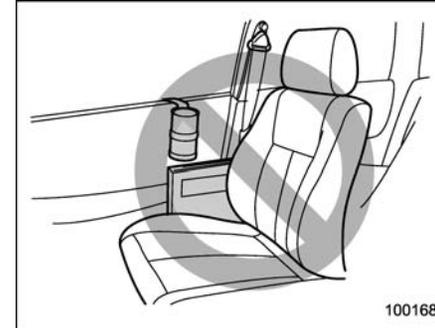

⚠ WARNING

- Do not attach accessories to the door trim or near either SRS side airbags and do not place objects near the SRS side airbags. In the event of the SRS side airbag deployment, they could be propelled dangerously toward the vehicle's occupants and cause injuries.
- Do not attach a hands-free microphone or any other accessory to a front pillar, a center pillar, a rear pillar, the windshield, a side window, an assist grip, or any other cabin surface that would be near a deploying SRS curtain airbag.

A hands-free microphone or other accessory in such a location could be propelled through the cabin with great force by the curtain airbag, or it could prevent correct deployment of the curtain airbag. In either case, the result could be serious injuries.

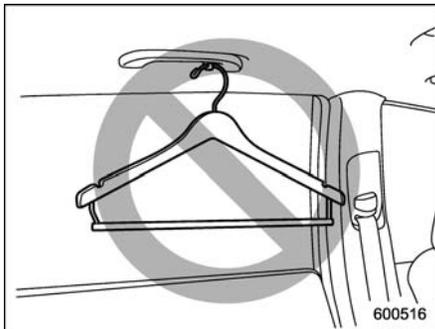

▲ WARNING

Do not hang coat hangers or other hard or pointed objects on the coat hooks. If such items were hanging on the coat hooks during deployment of the SRS curtain airbags, they could cause serious injuries by coming off the coat hooks and being thrown through the cabin or by

preventing deployment of the curtain airbags.

Before hanging clothing on the coat hooks, make sure there are no sharp objects in the pockets. Hang clothing directly on the coat hooks without using hangers.

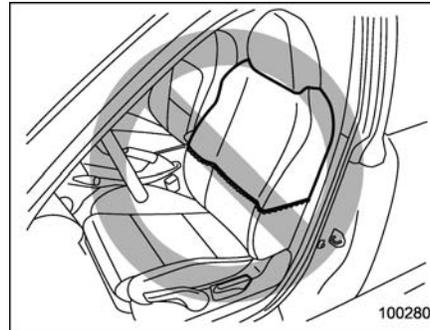

▲ WARNING

Do not put any kind of cover or clothes or other objects over either front seatback and do not attach labels or stickers to the front seat surface on or near the SRS side airbag. They could prevent proper deployment of the SRS side airbag, reducing protection available to the

front seat's occupant.

▼ Operation



The SRS side airbag and SRS curtain airbag can function only when the ignition switch is in the "ON" position.

The driver's and front passenger's SRS side airbags and SRS curtain airbags deploy independently of each other since each has its own impact sensor. Therefore, they may not both deploy in the same accident. Also, the SRS side airbag and SRS curtain airbag deploys independently of the driver's and front passenger's SRS frontal airbags in the steering wheel and instrument panel.

An impact sensor is located in each of the

- CONTINUED -

1-62 Seat, seatbelt and SRS airbags

left and right center pillars and rear wheel houses. In addition, the rollover sensor is inside the airbag control module.

If a center pillar impact sensor senses an impact force above a predetermined level in a side collision, the control module causes both the SRS side airbag and curtain airbag on the impacted side to inflate regardless of whether the rear wheel house impact sensor on the same side senses an impact. If it is a rear wheel house impact sensor alone that senses a sufficiently strong impact force, the control module causes only the SRS curtain airbag on the impacted side to inflate. If the rollover sensor detects rollover of the vehicle, the control module inflates the curtain airbag.

After deployment, the SRS side airbag immediately starts to deflate. The time required from detection of an impact to deflation of an SRS side airbag after deployment is shorter than the blink of an eye.

The SRS curtain airbag remains inflated for a while following deployment then slowly deflates.

The SRS side airbag and SRS curtain airbag deploy even when no one occupies the seat on the side on which an impact is

applied.

When the SRS side airbag and SRS curtain airbag deploy, a sudden, fairly loud inflation noise will be heard and some smoke will be released. These occurrences are a normal result of the deployment. This smoke does not indicate a fire in the vehicle.



CAUTION

Do not touch the SRS side airbag system components around the front seat seatback with bare hands right after deployment. Doing so can cause burns because the components can be very hot as a result of deployment.

After deployment, do not touch any part of the SRS curtain airbag system (from the front pillar to the part of the roof side over the rear seat). Doing so can cause burns because the components can be very hot as a result of deployment.

The SRS side airbag and SRS curtain airbag are designed to deploy in the event of an accident involving a moderate to severe side impact collision. Also, in the case of a rollover, the SRS curtain airbag deploys. They are basically not designed

to deploy in a lesser side impact. Also, they are basically not designed to deploy in frontal or rear impacts because SRS side airbag and SRS curtain airbag deployment would not help the occupant in those situations.

Each SRS side airbag and SRS curtain airbag are designed to function on a one-time-only basis.

SRS side airbag and SRS curtain airbag deployment depend on the level of force experienced in the passenger compartment during a side impact collision. That level differs from one type of collision to another, and it may have no bearing on the visible damage done to the vehicle itself. Also, the SRS curtain airbag deploys depending on the vehicle's position and inclination at the time of the rollover.

▽ Example of the type of accident in which the SRS side airbag will most likely deploy.

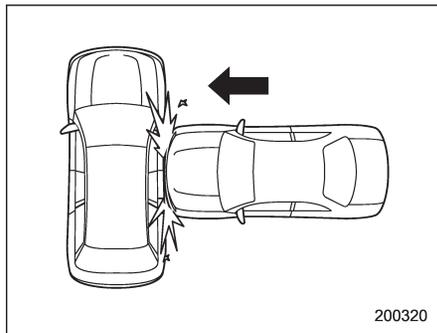

A severe side impact near the front seat activates the SRS side airbag.

- CONTINUED -

1-64 Seat, seatbelt and SRS airbags

▽ Examples of the types of accidents in which the SRS curtain airbag will most likely deploy.

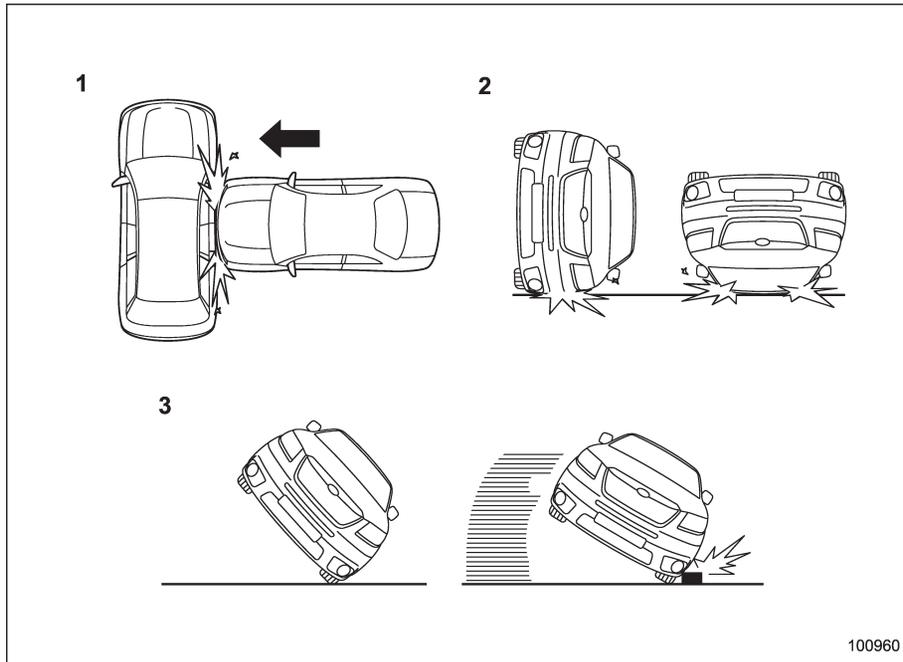

- 1) A severe side impact near the front seat or the rear seat activates the SRS curtain airbag.
- 2) The vehicle rolls onto its side or the roof.
- 3) If the angle of vehicle tip-up is marginal or if the skidding vehicle's tires hit a curbstone laterally.

▽ Examples of the types of accidents in which it is possible that the SRS side airbag and the SRS curtain airbag will deploy.

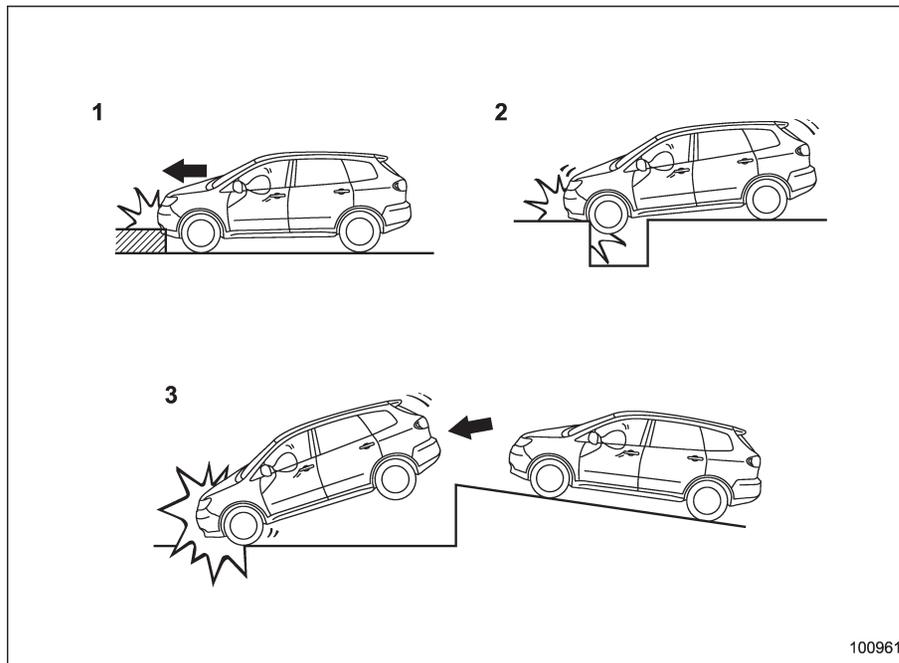

- 1) Hitting a curb, edge of pavement or hard surface
- 2) Falling into or jumping over a deep hole
- 3) Landing hard or vehicle falling

It is possible that the SRS side and curtain airbags will deploy if a serious impact occurs to the underside of your vehicle. Some examples are shown in the illustration.

– CONTINUED –

1-66 Seat, seatbelt and SRS airbags

▽ Examples of the types of accidents in which the SRS side airbag is unlikely to deploy.

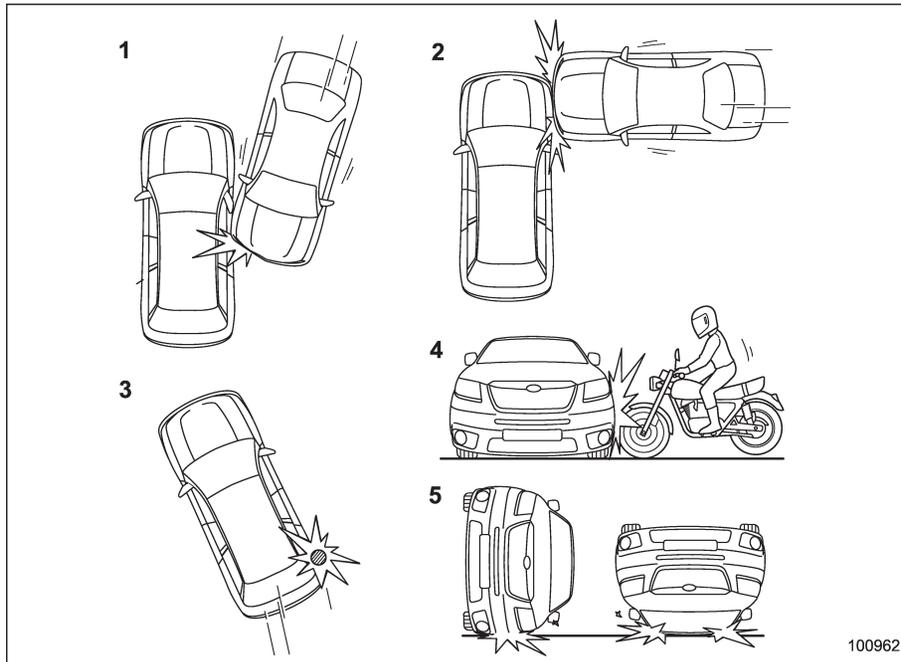

- 1) The vehicle is involved in an oblique side-on impact.
- 2) The vehicle is involved in a side-on impact in an area outside the vicinity of the passenger compartment.
- 3) The vehicle strikes a telephone pole or similar object.
- 4) The vehicle is involved in a side-on impact from a motorcycle.
- 5) The vehicle rolls onto its side or the roof.

There are many types of collisions which might not necessarily require SRS side airbag deployment. In the event of accidents like those illustrated, the SRS side airbag may not deploy depending on the level of accident forces involved.

▽ Examples of the types of accidents in which the SRS curtain airbag is unlikely to deploy.

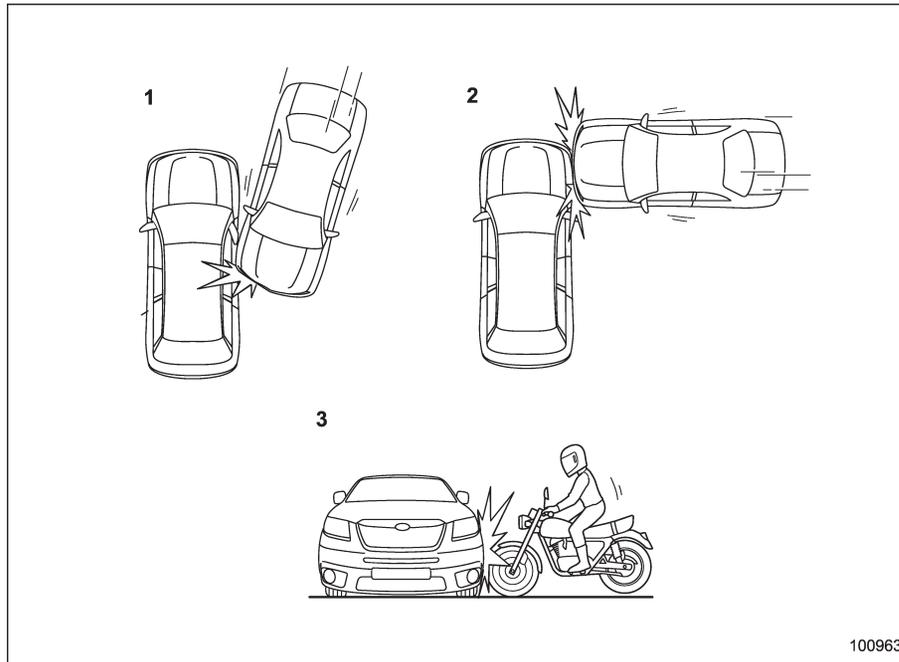

- 1) The vehicle is involved in an oblique side-on impact.
- 2) The vehicle is involved in a side-on impact in an area outside the vicinity of the passenger compartment.
- 3) The vehicle is involved in a side-on impact from a motorcycle.

There are many types of collisions which might not necessarily require SRS curtain airbag deployment. In the event of accidents like those illustrated, the SRS curtain airbag may not deploy depending on the level of accident forces involved.

▽ **Examples of the types of accidents in which the SRS side airbag and SRS curtain airbag will basically not deploy.**

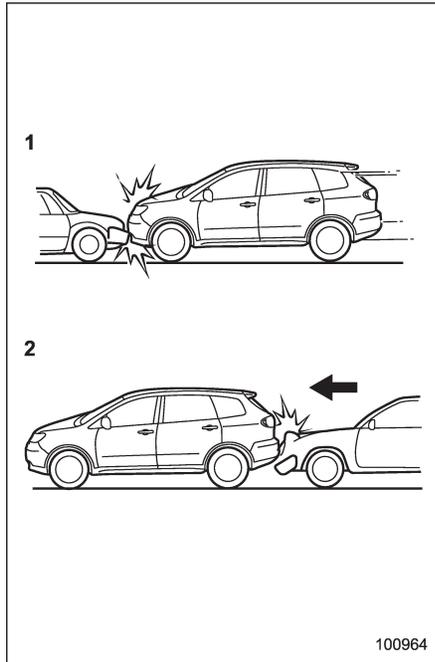

1) The vehicle is involved in frontal collision with another vehicle (moving or stationary).

2) The vehicle is struck from behind.
The SRS side airbag and SRS curtain airbag are basically not designed to deploy if the vehicle is involved in a frontal collision or is struck from behind. Examples of such accidents are illustrated.

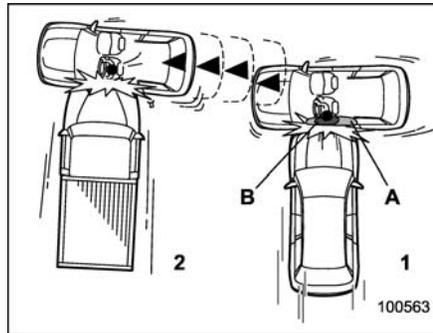

1) First impact
2) Second impact
A) SRS curtain airbag
B) SRS side airbag

In an accident where the vehicle is struck from the side more than once, the SRS side airbag and SRS curtain airbag deploy only once on the first impact.

Example: In the case of a double side impact collision, first with one vehicle and immediately followed by another from the same direction, once the SRS side airbag

and SRS curtain airbag are activated on the first impact, they will not be activated on the second.

▽ **Example of the type of accident in which the SRS curtain airbag will basically not deploy.**

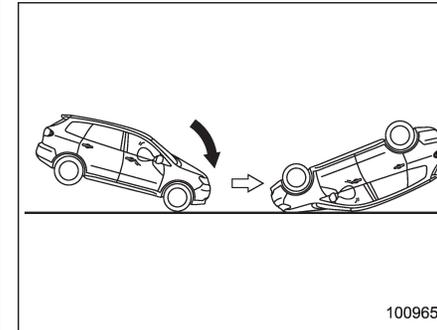

The SRS curtain airbags are not basically designed to deploy if the vehicle pitches end over end.

■ SRS airbag system monitors

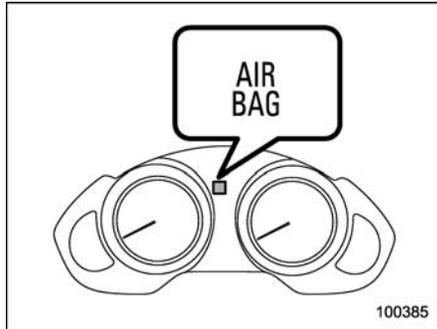

A diagnostic system continually monitors the readiness of the SRS airbag system (including front seatbelt pretensioners) while the vehicle is being driven. The SRS airbag system warning light "AIR-BAG" will show normal system operation by lighting for approximately 6 seconds when the ignition switch is turned to the "ON" position.

The following components are monitored by the indicator:

- Front sub sensor (right-hand side)
- Front sub sensor (left-hand side)
- Airbag control module (including impact and rollover sensors)
- Frontal airbag module (driver's side)
- Frontal airbag module (front passen-

ger's side)

- Side airbag sensor (center pillar right-hand side)
- Side airbag sensor (center pillar left-hand side)
- Side airbag module (driver's side)
- Side airbag module (front passenger's side)
- Curtain airbag sensor (rear wheel house right-hand side)
- Curtain airbag sensor (rear wheel house left-hand side)
- Curtain airbag module (right side)
- Curtain airbag module (left side)
- Seatbelt pretensioner (driver's side)
- Seatbelt pretensioner (front passenger's side)
- Seatbelt buckle switch (driver's side)
- Seatbelt buckle switch (front passenger's side)
- Driver's seat position sensor
- Front passenger's seatbelt tension sensor
- Front passenger's occupant detection system weight sensor
- Front passenger's occupant detection control module
- Front passenger's frontal airbag ON and OFF indicator
- All related wiring

⚠ WARNING

If the warning light exhibits any of the following conditions, there may be a malfunction in the seatbelt pretensioners and/or SRS airbag system. Immediately take your vehicle to your nearest SUBARU dealer to have the system checked. Unless checked and properly repaired, the seatbelt pretensioners and/or SRS airbags will operate improperly (e.g. SRS airbags may inflate in a very minor collision or not inflate in a severe collision), which may increase the risk of injury.

- Flashing or flickering of the warning light
- No illumination of the warning light when the ignition switch is first turned to the "ON" position
- Continuous illumination of the warning light
- Illumination of the warning light while driving

– CONTINUED –

■ SRS airbag system servicing

WARNING

- When discarding an airbag module or scrapping the entire vehicle damaged by a collision, consult your SUBARU dealer.
- The SRS airbag has no user-serviceable parts. Do not use electrical test equipment on any circuit related to the SRS airbag system. For required servicing of the SRS airbag, see your nearest SUBARU dealer. Tampering with or disconnecting the system's wiring could result in accidental inflation of the SRS airbag or could make the system inoperative, which may result in serious injury.

CAUTION

If you need service or repair in areas listed in the following, have an authorized SUBARU dealer perform the work. The SRS airbag control module, impact sensors and airbag modules are stored in these areas.

- Under the center console

- Inside each front fender
- Steering wheel and column and nearby areas
- Top of the dashboard on front passenger's side and nearby areas
- Each front seat and nearby area
- Inside each center pillar
- In each roof side (from the front pillar to a point over the rear seat)
- Between the rear seat cushion and rear wheel house on each side

In the event that the SRS airbag is deployed, replacement of the system should be performed only by an authorized SUBARU dealer. When the components of the SRS airbag system are replaced, use only genuine SUBARU parts.

NOTE

In the following cases, contact your SUBARU dealer as soon as possible.

- The front part of the vehicle was involved in an accident in which only the driver's SRS frontal airbag or both driver's and front passenger's SRS frontal airbags did not deploy.
- The pad of the steering wheel, the

cover over the front passenger's SRS frontal airbag, or either roof side (from the front pillar to a point over the rear seat) is scratched, cracked, or otherwise damaged.

- Either center pillar and rear wheel house or a nearby area of the vehicle was involved in an accident in which the SRS side airbag and SRS curtain airbag did not deploy.
- The fabric or leather of either front seatback is cut, frayed, or otherwise damaged.

■ Precautions against vehicle modification

WARNING

- To avoid accidental activation of the system or rendering the system inoperative, which may result in serious injury, no modifications should be made to any components or wiring of the SRS airbag system.

This includes following modifications:

- Installation of custom steering wheels
- Attachment of additional trim

materials to the dashboard

- Installation of custom seats
- Replacement of seat fabric or leather
- Installation of additional fabric or leather on the front seat
- Attachment of a hands-free microphone or any other accessory to a front pillar, a center pillar, a rear pillar, the windshield, a side window, an assist grip, or any other cabin surface that would be near a deploying SRS curtain airbag.
- Installation of additional electrical/electronic equipment such as a mobile two-way radio on or near the SRS airbag system components and/or wiring is not advisable. This could interfere with proper operation of the SRS airbag system.

 **CAUTION**

Do not perform any of the following modifications. Such modifications can interfere with proper operation of the SRS airbag system.

- Attachment of any equipment (bush bar, winches, snow plow, skid plate, etc.) other than genuine SUBARU accessory parts.
- Modification of the suspension system or front end structure.
- Installation of a tire of different size and construction from the tires specified on the vehicle placard attached to the driver's door pillar or specified for individual vehicle models in this Owner's Manual.
- Attachment of any equipment (side steps or side sill protectors, etc.) other than genuine SUBARU accessory parts to the side body.

Always consult your SUBARU dealer if you want to install any accessory parts on your vehicle.

Keys and doors

Keys	2-2	Replacing lost transmitters	2-12
Key number plate	2-2	Alarm system	2-15
Immobilizer	2-3	System operation	2-15
Security ID plate	2-3	Activating and deactivating the alarm system	2-15
Security indicator light	2-4	If you have accidentally triggered the alarm system	2-16
Key replacement	2-4	Arming the system	2-16
Door locks	2-4	Disarming the system	2-17
Locking and unlocking from the outside	2-4	Valet mode	2-17
Locking and unlocking from the inside	2-5	Passive arming	2-18
Battery drainage prevention function	2-6	Tripped sensor identification	2-19
Power door locking switches	2-6	Shock sensors (dealer option)	2-19
Key lock-in prevention function	2-7	Child safety locks	2-19
Remote keyless entry system	2-8	Windows	2-20
Locking the doors	2-9	Power windows	2-20
Unlocking the doors	2-9	Rear gate	2-22
Unlocking the rear gate	2-9	Moonroof (if equipped)	2-24
Illuminated entry	2-9	Tilt function	2-24
Vehicle finder function	2-10	Sliding function	2-25
Sounding a panic alarm	2-10	Anti-entrapment function	2-25
Selecting audible signal operation	2-10	Sun shade	2-25
Replacing the battery	2-10		

2-2 Keys and doors

Keys

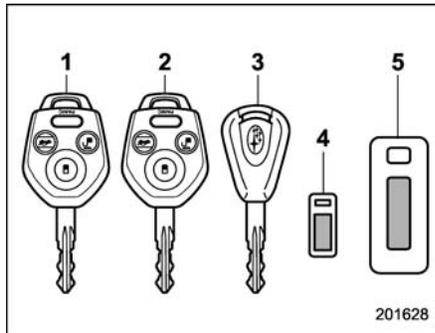

- 1) Master key
- 2) Submaster key
- 3) Valet key
- 4) Key number plate
- 5) Security ID plate

Three types of keys are provided for your vehicle.

Master key, submaster key and valet key.

The master key and submaster key fit all locks on your vehicle.

- Ignition switch
- Driver's door
- Glove box

The valet key fits only the ignition switch and door locks. You can keep the glove

box locked when you leave your vehicle and valet key at a parking facility.

CAUTION

Do not attach a large key holder or key case to either key. If it bangs against your knees while you are driving, it could turn the ignition switch from the "ON" position to the "Acc" or "LOCK" position, thereby stopping the engine.

■ Key number plate

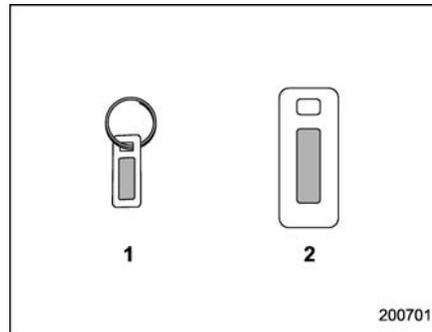

- 1) Key number plate
- 2) Security ID plate

The key number is stamped on the key number plate attached to the key set.

Write down the key number and keep it in another safe place, not in the vehicle. This number is needed to make a replacement key if you lose your key or lock it inside the vehicle.

For information on making replacement keys for vehicles with the immobilizer system, refer to the "Immobilizer" section in this chapter.

Immobilizer

The immobilizer system is designed to prevent an unauthorized person from starting the engine. Only keys registered with your vehicle's immobilizer system can be used to operate your vehicle. Even if an unregistered key fits into the ignition switch and can be turned to the "START" position, the engine will automatically stop after several seconds.

Each immobilizer key contains a transponder in which the key's ID code is stored. When a key is inserted into the ignition switch and turned to the "ON" position, the transponder transmits the key's ID code to the immobilizer system's receiver. If the transmitted ID code matches the ID code registered in the immobilizer system, the system allows the engine to be started. Since the ID code is transmitted and acted upon almost instantly, the immobilizer system does not impede normal starting of the engine.

If the engine fails to start, pull out the key once before trying again. Refer to the "Ignition switch" section in chapter 3.

This device complies with Part 15 of the FCC Rules and with RSS-210 of Industry Canada. Operation is subject to the following two conditions: (1) This

device may not cause harmful interference, and (2) this device must accept any interference received, including interference that may cause undesired operation.

Changes or modifications not expressly approved by the party responsible for compliance could void the user's authority to operate the equipment.

NOTE

To protect your vehicle from theft, please pay close attention to the following security precautions:

- **Never leave your vehicle unattended with its keys inside.**
- **Before leaving your vehicle, close all windows and lock the doors and rear gate.**
- **Do not leave spare keys or any record of your key number in the vehicle.**

CAUTION

- **Do not place the key under direct sunlight or anywhere it may become hot.**

- **Do not get the key wet. If the key gets wet, wipe it dry with a cloth immediately.**

Security ID plate

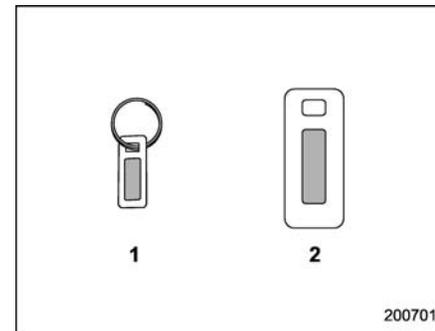

- 1) Key number plate
- 2) Security ID plate

The security ID is stamped on the security ID plate attached to the key set. Write down the security ID and keep it in another safe place, not in the vehicle. This number is needed to make a replacement key if you lose your key or lock it inside the vehicle.

This number is also needed for replacement or repair of the engine control unit, integrated unit, and combination meter.

– CONTINUED –

■ Security indicator light



The security indicator light deters potential thieves by indicating that the vehicle is equipped with an immobilizer system. It begins flashing approximately 60 seconds after the ignition switch is turned from the "ON" position to the "Acc" or "LOCK" position or immediately after the key is pulled out.

If the security indicator light does not flash, the immobilizer system may be malfunctioning. If this occurs, contact your SUBARU dealer as soon as possible.

In case an unauthorized key is used (e.g. an imitation key), the security indicator light illuminates.

NOTE

Even if the security indicator light flashes irregularly or its fuse blows (the light does not flash if its fuse is blown), the immobilizer system will function normally.

■ Key replacement

Your key number plate and security ID plate will be required if you ever need a replacement key made. Any new key must be registered for use with your vehicle's immobilizer system before it can be used. Up to four keys can be registered for use with one vehicle.

For security, all the keys registered with your vehicle's immobilizer system will have their ID codes erased and re-registered when a new key is made. Therefore, all of your vehicle's keys must be presented when a new key is registered. Any key that is not re-registered when a new key is made cannot be used after the other keys are re-registered. For information on replacement keys and on the registration of keys with your immobilizer system, contact your SUBARU dealer.

Door locks

■ Locking and unlocking from the outside

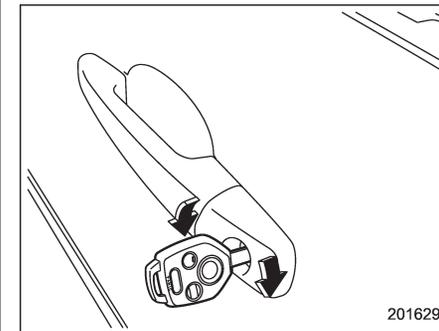

To lock the driver's door from the outside with the key, turn the key toward the front. To unlock the door, turn the key toward the rear.

Lift the outside door handle to open an unlocked door.

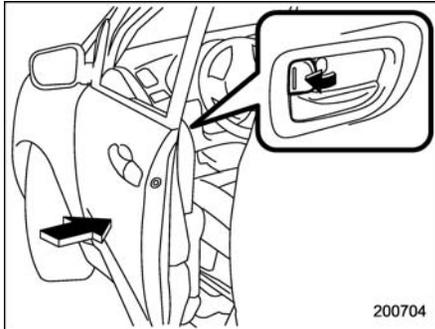

Locking without the key

To lock the door from the outside without the key, rotate the lock lever rearward and then close the door.

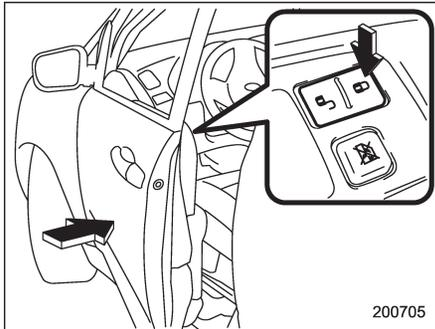

Locking without the key

To lock the door from the outside using the

power door locking switch, push the “” sides of the switch and then close the door. In this case, all closed doors and the rear gate are locked at the same time.

Always make sure that all doors and the rear gate are locked before leaving your vehicle.

NOTE

Make sure that you do not leave the key inside the vehicle before locking the doors from the outside without the key.

■ Locking and unlocking from the inside

⚠ WARNING

Keep all doors locked when you drive, especially when small children are in your vehicle.

Along with the proper use of seatbelts and child restraints, locking the doors reduces the chance of being thrown out of the vehicle in an accident.

It also helps prevent passengers from falling out if a door is accidentally opened, and intruders from unexpectedly opening doors and entering your vehicle.

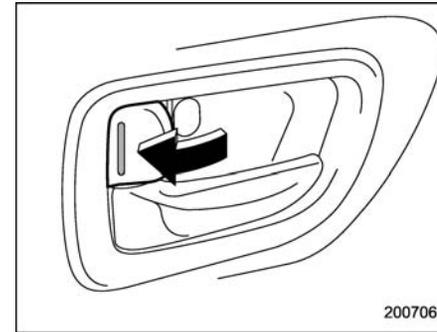

To lock the door from the inside, rotate the lock lever rearward.

2-6 Keys and doors

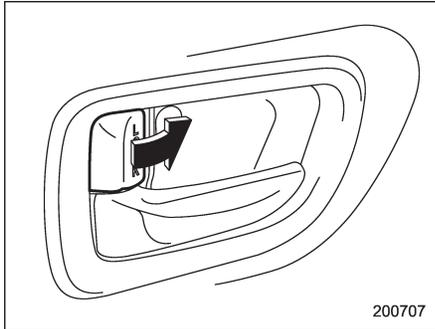

To unlock the door from the inside, rotate the lock lever forward.

The red mark on the lock lever appears when the door is unlocked.

Pull the inside door handle to open an unlocked door.

Always make sure that all doors and the rear gate are closed and locked before starting to drive.

■ Battery drainage prevention function

When a door or the rear gate is not completely closed and the map light, dome light, ignition switch light, and door open warning light remain illuminated as a result, the lights are automatically turned off by the battery drainage prevention

function after 10 minutes of illumination to prevent the battery from going dead. The operational/non-operational setting of this function can be changed by a SUBARU dealer. Contact the nearest SUBARU dealer if you would like to change the setting.

NOTE

- When leaving the vehicle, please make sure that all doors and the rear gate are completely closed.
- The battery drainage prevention function does not operate while the key is in the ignition switch.

Power door locking switches

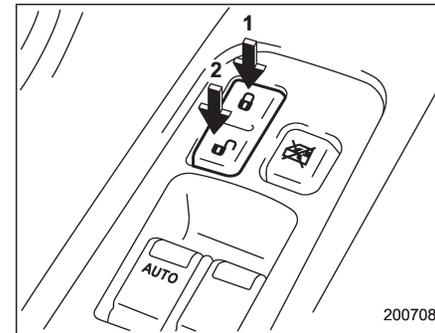

Driver's switch

- 1) Lock
- 2) Unlock

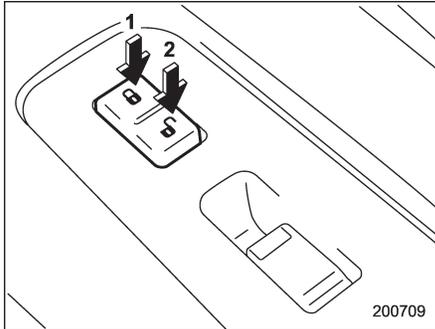

Front passenger's switch

- 1) Lock
- 2) Unlock

All doors and the rear gate can be locked and unlocked by the power door locking switches located at the driver's side and the front passenger's side doors.

To lock all doors and the rear gate, push the "1" side of the switch.

To unlock all doors and the rear gate, push the "2" side of the switch.

When you close the doors after you set the door locks, the doors remain locked.

NOTE

Make sure that you do not leave the key inside the vehicle before locking the doors from the outside using the power

door locking switches.

■ Key lock-in prevention function

This function prevents the doors from being locked with the key still in the ignition switch.

▼ Behavior with key lock-in prevention function operational

With either the driver's or front passenger's door open, the doors automatically remain unlocked even if the "1" side of the door locking switch is pushed.

▼ Behavior with key lock-in prevention function non-operational

- If the lock lever is turned to the rear ("LOCK") position with the driver's door open and the driver's door is then closed with the lock lever in that position, the driver's door is locked.
- If the spare key is used to lock the driver's door from the outside of the vehicle, the door is locked.
- It is possible to lock the all doors and the rear gate by holding the "1" side of the door locking switch pushed for 3 seconds with the driver's door open and then closing the driver's door.

This function's operational/non-opera-

tional setting can be changed by a SUBARU dealer. Contact a SUBARU dealer for details.

NOTE

When leaving the vehicle, make sure you are holding the key before locking the doors.

Remote keyless entry system

CAUTION

- Do not expose the transmitter to severe shocks, such as those experienced as a result of dropping or throwing.
- Do not take the transmitter apart except when replacing the battery.
- Do not get the transmitter wet. If it gets wet, wipe it dry with a cloth immediately.

This device complies with Part 15 of the FCC Rules and with RSS-210 of Industry Canada. Operation is subject to the following two conditions: (1) This device may not cause harmful interference, and (2) this device must accept any interference received, including interference that may cause undesired operation.

Changes or modifications not expressly approved by the party responsible for compliance could void the user's authority to operate the equipment.

The transmitter for the remote keyless

entry system is located inside the key head.

The remote keyless entry system has the following functions.

- Locking and unlocking the doors and rear gate without a key
- Unlocking the rear gate without key
- Sounding a panic alarm
- Arming and disarming the alarm system. Refer to the next section "Alarm system" for detailed information.

The operable distance of the remote keyless entry system is approximately 30 feet (10 meters). However, this distance will vary depending on environmental conditions.

The system's operable distance will be shorter in areas near a facility or electronic equipment emitting strong radio waves such as a power plant, broadcast station, TV tower, or remote controller of home electronic appliances.

NOTE

The remote keyless entry system does not operate when the ignition key is inserted in the ignition switch or when any of the doors or the rear gate is not fully closed.

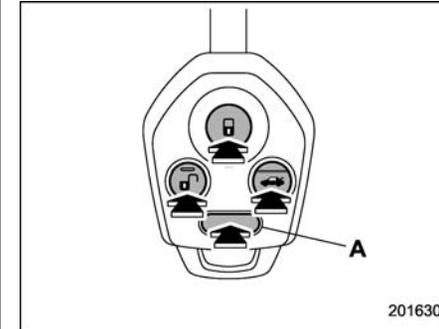

- 🚗: Rear gate unlock button
- 🔓: Unlock/disarm button
- 🔒: Lock/arm button
- A: Panic button

■ Locking the doors

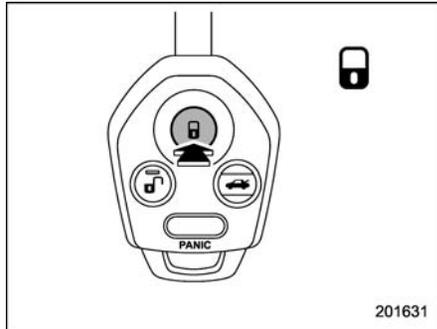

Press the “” button to lock all doors and rear gate. An electronic chirp will sound once and the turn signal lights will flash once.

If any of the doors or the rear gate is not fully closed, an electronic chirp will sound five times and the turn signal lights will flash five times to alert you that the doors or the rear gate are not properly closed. When you close the door, it will automatically lock and then an electronic chirp will sound once and the turn signal lights will flash once.

■ Unlocking the doors

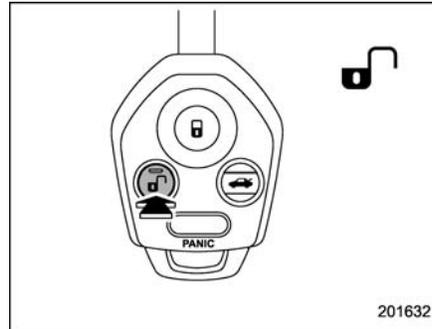

Press the “” button to unlock the driver's door. An electronic chirp will sound twice and the turn signal lights will flash twice. To unlock all doors and the rear gate, briefly press the “” button a second time within 5 seconds.

NOTE

If the interval between the first and second presses of the “” button (for unlocking of all of the doors and the rear gate) is extremely short, the system may not respond.

■ Unlocking the rear gate

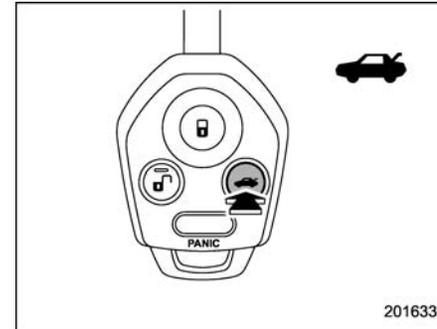

Pressing the “” button opens the rear gate.

An electronic chirp will sound twice and the turn signal lights will flash twice.

■ Illuminated entry

Interior lights such as the map light, dome light and cargo area light will illuminate when the “” button is pressed. These lights remain illuminated for approximately 30 seconds if any of the doors or the rear gate is not opened.

If the “” button is pressed before 30 seconds have elapsed, these lights will turn off.

To activate this function, set the following interior light switches to the indicated

– CONTINUED –

2-10 Keys and doors

positions:

Map light: **OFF** position

Dome light: **DOOR** position

Cargo area light: **DOOR** position

A SUBARU dealer can change the illumination period setting of the interior lights in accordance with your preference. Contact the nearest SUBARU dealer for details.

■ Vehicle finder function

Use this function to find your vehicle parked among many vehicles in a large parking lot. Provided you are within 30 feet (10 meters) of the vehicle, pressing the "P" button three times in a 5-second period will cause your vehicle's horn to sound once and its turn signal lights to flash three times.

NOTE

If the interval between presses is too short when you press the "P" button three times, the system may not respond to the signals from the remote transmitter.

■ Sounding a panic alarm

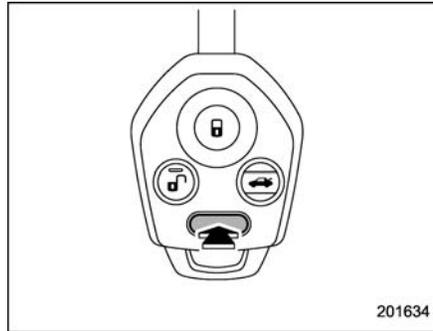

To activate the alarm, press the "PANIC" button once.

The horn will sound and the turn signal lights will flash.

To deactivate the panic alarm, press any button on the remote transmitter. Unless a button on the remote transmitter is pressed, the alarm will be deactivated after approximately 30 seconds.

■ Selecting audible signal operation

Using an electronic chirp, the system will give you an audible signal when the doors lock and unlock. If desired, you may turn the audible signal off.

Do the following to deactivate the audible

signal. You can also use the same steps to restore the function.

1. Sit in the driver's seat and shut all doors and the rear gate.
2. Hold down the UNLOCK side of the power door locking switch.
3. While holding down the "UNLOCK" side of the power door locking switch, pull the key out and re-insert it into the ignition switch at least 6 times within 10 seconds after Step 2.
4. Open and close the driver's door once within 10 seconds after step 3.
5. The turn signal lights flash 3 times to indicate completion of the setting.

You may have the above settings done by your SUBARU dealer.

■ Replacing the battery

CAUTION

- Do not let dust, oil or water get on or in the transmitter when replacing the battery.
- Be careful not to damage the printed circuit board in the transmitter when replacing the battery.
- Be careful not to allow children to touch the battery and any removed parts; children could

swallow them.

When the transmitter battery begins to get weak, transmitter range will begin to decrease. Replace the battery as soon as possible.

To replace the battery:

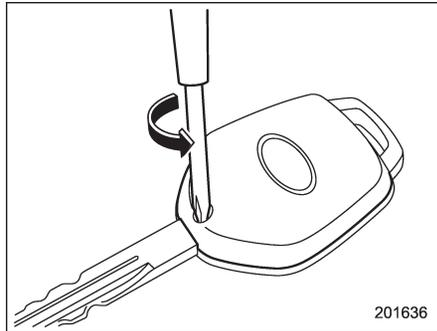

1. Remove the screw on the key head.

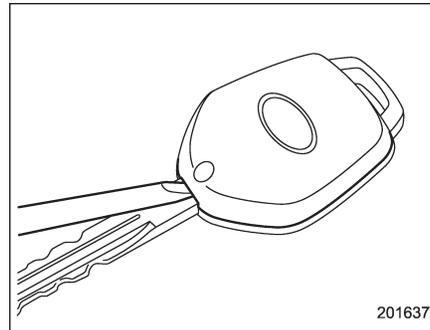

2. Open the key head using a flat-head screwdriver.

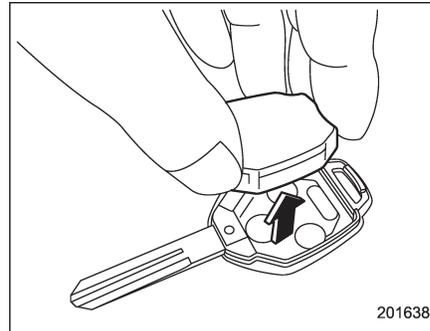

3. Remove the transmitter case from the key head.

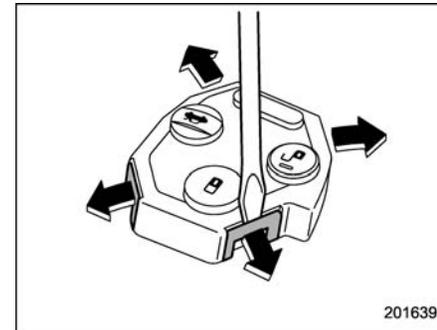

4. Open the transmitter case by releasing the hooks.
5. Remove the old battery from the holder.

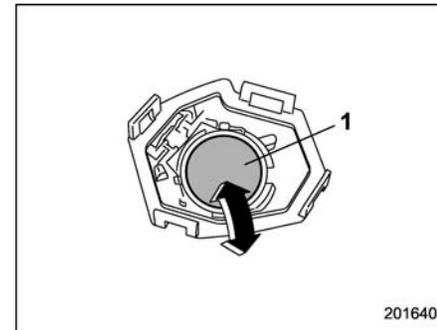

1) Negative (-) side facing up

2-12 Keys and doors

6. Replace with a new battery (Type CR1620 or equivalent) making sure to install the new battery with the negative (-) side facing up.
7. Put together the transmitter case by fitting the hooks on both sides of the case.
8. Put the transmitter case in the key head and then put together the key head.
9. Reinstall the screw on the key head.

After the battery is replaced, the transmitter must be synchronized with the remote keyless entry system's control unit. Press either the "⏏" or "⏏" button six times to synchronize the unit.

■ Replacing lost transmitters

If you lose a transmitter or want to purchase additional transmitters (up to four can be programmed), you should re-program all of your transmitters for security reasons. It is recommended that you have your dealer program all of your transmitters into your system.

▼ Programming the transmitters

The remote keyless entry system is equipped with a special code learning feature that allows you to program new transmitter codes into the system or to delete old ones. The system can learn up to four unique transmitter codes. The four transmitter codes may be the same or

different.

Programming transmitter codes into system:

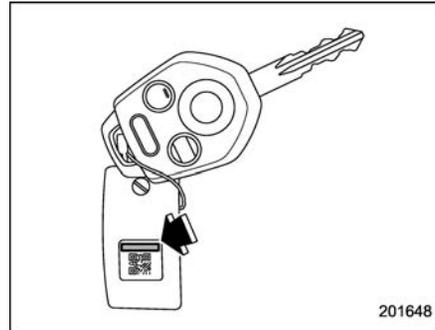

Key tag

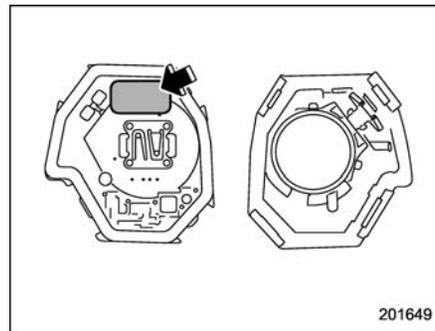

Transmitter circuit board

To register a new transmitter with the

remote keyless entry system, it is necessary to program the transmitter's code (identification number) into the system. A tag showing the code is affixed to the key unit, and another is affixed to the circuit board inside the transmitter. If there is no tag, open the transmitter case and make a note of the eight-digit number. Program the number into the system in accordance with the following procedure:

1. Firmly close the doors and the rear gate.
2. Open the driver's door, sit on the driver's seat, and close the door.
3. Perform the following steps within 45 seconds.

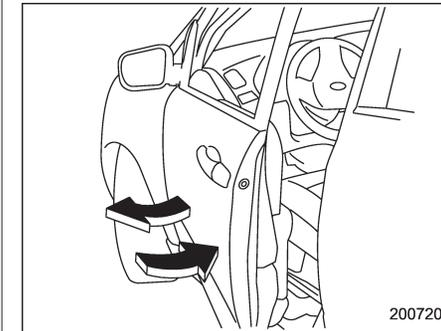

- (1) Open and close the driver's door once.

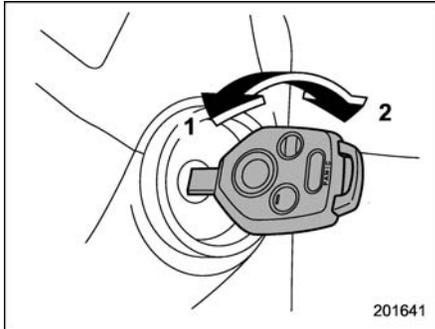

- 1) LOCK
- 2) ON

(2) Insert the key into the ignition switch, then turn it from the "LOCK" position to the "ON" position 10 times within 15 seconds.

NOTE

- When you complete step (2), an electronic tone will sound once, a buzzer will continue to sound and the interior light will continue to flash until the transmitter codes are completely registered.
- If you do not perform steps (1) and (2) within 45 seconds, an error will occur. Neither an electronic tone nor the buzzer will sound, and the interior lamp will not flash. In this event, per-

form the whole procedure again beginning with part 1.

- 4. Open and close the door once within 15 seconds.

NOTE

- When part 4 of the procedure is completed, an electronic tone will sound for 30 seconds.
- If you do not perform the operations in part 4 within 15 seconds, an error will occur and the electronic tone will not sound. In this event, perform the registration steps again beginning with part 3 of the procedure.

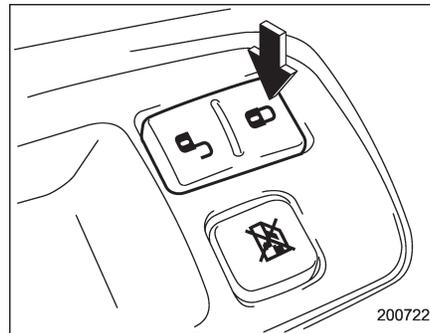

- 5. Before the electronic tone stops sounding, push the "LOCK" side of the power door locking switch the same number of

times as the leftmost digit of the transmitter code. For example, push the locking switch eight times if the leftmost digit of the code is 8.

NOTE

- The electronic tone will stop sounding when you start entering the number.
- If you do not start entering the number using the lock knob before the electronic tone stops sounding, an error will occur. In this event, perform the registration steps again beginning with part 3 of the procedure.
- If the interval between one push of the knob and the next exceeds 5 seconds, an error will occur. In this event, perform the procedure again beginning with part 4. If an error occurs six times, perform the procedure again starting with part 3.

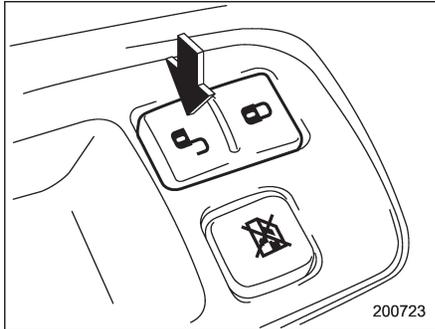

6. When you have finished entering the number, push the “” side of the locking switch within 5 seconds.

NOTE

- An electronic tone will sound.
- If you push the “” side of the locking switch when more than 5 seconds have passed, an error will occur. In this event, perform the procedure again beginning with part 4. If an error occurs six times, perform the procedure again starting with part 3.

7. Perform parts 5 and 6 of the procedure for each of the remaining digits of the transmitter code beginning with the second digit (counting from the left) and finishing with the eighth digit.

NOTE

- When you finish entering the eighth digit, an electronic tone will sound for 30 seconds.
- If the interval between one push of the switch and the next exceeds 5 seconds, an error will occur. In this event, perform the procedure again beginning with part 4. If an error occurs six times, perform the procedure again starting with part 3.

8. Before the electronic tone stops sounding, use the power door locking switch to reenter the transmitter code beginning with the leftmost digit.

NOTE

If you do not start entering the number using the lock knob before the electronic tone stops sounding, an error will occur. In this event, perform the procedure again beginning with part 3.

9. When you have finished entering the code a second time, an electronic tone will sound for 1 second and automatic door locking and unlocking operation will take place once to indicate completion of registration, provided the code entered the second time is identical to that entered the first time.

NOTE

If the code entered the second time is not identical to the code entered the first time, an error will occur. In this event, perform the procedure again beginning with part 5. If an error occurs five times, perform the procedure again starting with part 3.

10. If you wish to program another transmitter code into the system (up to four transmitter codes can be programmed into the system), perform the procedure beginning with part 4. When you have finished programming all of the necessary transmitter codes into the system, remove the key from the ignition switch.

11. Test every registered transmitter to confirm correct operation.

▼ Deleting old transmitter codes

The control unit of the remote keyless entry system has four memory locations to store transmitter codes, giving it the ability to operate with up to four transmitters. When you lose a transmitter, the lost transmitter's code remains in the memory. For security reasons, lost transmitter codes should be deleted from the memory.

To delete old transmitter codes, program four transmitter codes into the system. If

you have only one current transmitter, program it four times. If you have two current transmitters, program each one twice. If you have three current transmitters, program two of them once and the third one twice. This process will leave only current transmitter codes in the system's memory.

NOTE

Make sure no one else is operating their keyless entry system within range of your vehicle when programming transmitters. If someone else were to operate their remote transmitter while you are programming your transmitters, it is possible that their transmitter code will be programmed into your system, allowing them unauthorized access to your vehicle.

Alarm system

The alarm system helps to protect your vehicle and valuables from theft. The horn sounds and the turn signal lights flash if someone attempts to break into your vehicle.

The system can be armed and disarmed with the remote transmitter.

The system does not operate when the key is inserted into the ignition switch.

Your vehicle's alarm system has been set for activation at the time of shipment from the factory. You can set the system for deactivation yourself or have it done by your SUBARU dealer.

■ System operation

The alarm system will give the following alarms when triggered:

- The vehicle's horn will sound and the turn signal lights will flash for 30 seconds.
- If any door or the rear gate remains open after the 30-second period, the horn will continue to sound for a maximum of 3 minutes. If the door or the rear gate is closed while the horn is sounding, the horn will stop sounding with a delay of up to 30 seconds.

The alarm is triggered by:

- Opening a door or the rear gate
- Physical impact to the vehicle, such as forced entry (only vehicles with shock sensors (dealer option))

■ Activating and deactivating the alarm system

To change the setting of your vehicle's alarm system for activation or deactivation, do the following.

1. Disarm the alarm system. Refer to "Disarming the system" in this section.
2. Sit in the driver's seat and shut all doors and the rear gate.
3. Turn the ignition switch to the "ON" position.
4. Hold down the UNLOCK side of the driver's power door locking switch, open the driver's door within the following 1 second, and wait 10 seconds without releasing the switch. The setting will then be changed as follows:

If the system was previously activated:

The odometer/trip meter screen displays "AL oF" and the horn sounds twice, indicating that the system is now deactivated.

– CONTINUED –

2-16 Keys and doors

If the system was previously deactivated:

The odometer/trip meter screen displays "AL on" and the horn sounds once, indicating that the system is now activated.

NOTE

You may have the above setting change done by your SUBARU dealer.

■ If you have accidentally triggered the alarm system

▼ To stop the alarm

Do any of the following operations:

- Press any button on the remote transmitter.
- Turn the ignition switch to the "ON" position.

■ Arming the system

▼ To arm the system using remote transmitter

1. Close all windows and the moonroof.
2. Remove the key from the ignition switch.
3. Open the doors and get out of the vehicle.
4. Make sure that the engine hood is locked.

5. Close all doors and the rear gate.

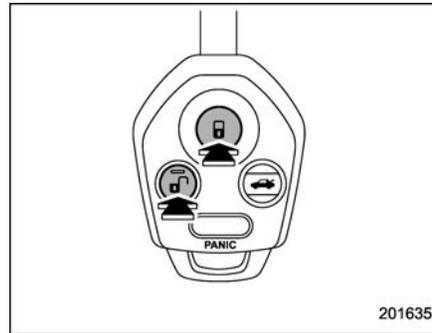

 : Press to Arm the system.

 : Press to Disarm the system.



6. Briefly press the "SECURITY" button (for less than 2 seconds). All doors and the rear gate will lock, an electronic chirp will

sound once, the turn signal lights will flash once and the indicator lights will start flashing rapidly. After rapid flashing for 30 seconds (standby time), the indicator lights will then flash slowly (twice approximately every 2 seconds), indicating that the system has been armed for surveillance.

If any of the doors or the rear gate is not fully closed, an electronic chirp sounds five times, the turn signal lights flash five times to alert you that the doors or the rear gate are not properly closed. When you close the door, the system will automatically arm and doors will automatically lock.

▼ To arm the system using power door locking switches

1. Close all windows.
2. Remove the key from the ignition switch.
3. Open the doors and get out of the vehicle.
4. Make sure that the engine hood is locked.
5. Close the doors and the rear gate but leave only the driver's door or the front passenger's door open.

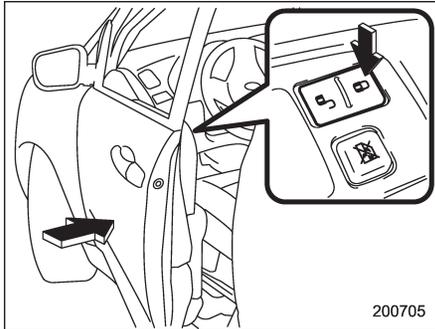

6. Push the front side (“LOCK” side) of the power door locking switch to set the door locks.

7. Close the door. An electronic chirp will sound once, the turn signal lights will flash once and the indicator lights will start flashing rapidly. After rapid flashing for 30 seconds (standby time), the indicator lights will then flash slowly (twice approximately every 2 seconds), indicating that the system has been armed for surveillance.

NOTE

- The system can be armed even if the engine hood, the windows and/or moonroof are opened. Always make sure that they are fully closed before arming the system.

- The 30-second standby time can be eliminated if you prefer. Have it performed by your SUBARU dealer.
- The system is in the standby mode for a 30-second period after locking the doors with the remote transmitter. The security indicator light will flash at short intervals during this period.
- If any of the following actions is done during the standby period, the system will not switch to the surveillance state.
 - Doors are unlocked using the remote transmitter.
 - Any door or the rear gate is opened.
 - Ignition switch is turned to the “ON” position.

■ Disarming the system

Briefly press the “” button (for less than 2 seconds) on the remote transmitter. The driver’s door will unlock, an electronic chirp will sound twice, the turn signal lights will flash twice and the indicator light will turn off.

To unlock all other doors and the rear gate, briefly press the “” button a second time within 5 seconds.

NOTE

If the interval between the first and second presses of the “” button (for unlocking of all of the doors and the rear gate) is extremely short, the system may not respond.

▼ Emergency disarming

If you cannot disarm the system using the transmitter (i.e. the transmitter is lost, broken or the transmitter battery is too weak), you can disarm the system without using the transmitter.

The system can be disarmed if you turn the ignition switch from the “LOCK” to the “ON” position with a registered key.

■ Valet mode

When you choose the valet mode, the alarm system does not operate. In valet mode, the remote transmitter is used only for locking and unlocking the doors and rear gate and panic activation.

To enter the valet mode, change the setting of your vehicle’s alarm system for deactivation mode. Refer to “Activating and deactivating the alarm system” in this section. The security indicator light will continue to flash once every 3 seconds indicating that the system is in the valet mode.

– CONTINUED –

2-18 Keys and doors

To exit valet mode, change the setting of your vehicle's alarm system for activation mode. Refer to "Activating and deactivating the alarm system" in this section.

■ Passive arming

When passive arming mode has been programmed by the dealer, arming of the system is automatically accomplished without using the remote transmitter. Note that in this mode, **DOORS MUST BE MANUALLY LOCKED**.

▼ To enter the passive mode

If you wish to program the passive arming mode, have it done by your SUBARU dealer.

▼ Arming the system

⚠ CAUTION

In passive mode, the system will automatically activate the alarm but WILL NOT automatically lock the doors. In order to lock the doors you must either lock them as indicated in step 4 below or with the key once they have been closed. Failure to lock the doors manually will result in a higher security risk.

1. Turn the ignition switch to the "ON"

position.

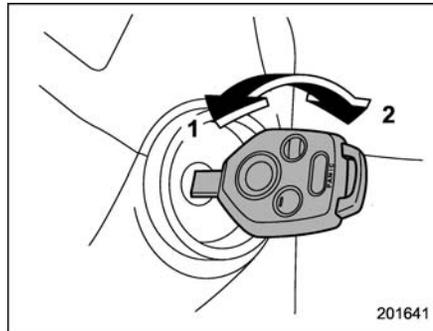

- 1) LOCK
- 2) ON

2. Turn the ignition switch from "ON" to "LOCK" position and remove the key from the ignition switch.
3. Open the doors and get out of the vehicle.

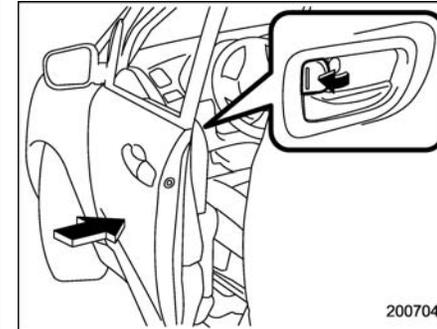

4. Before closing the doors, lock all doors with the inside door lock levers.
5. Close the doors. The system will automatically arm after 1 minute.

In the passive mode, the system can also be armed with the remote transmitter or with the power door locking switches. If the remote transmitter or power door locking switch is used to lock the vehicle, arming will take place immediately regardless of whether or not the passive mode has been selected.

▼ Disarming the system

To disarm the system, briefly press the "⏏" button on the transmitter.

■ Tripped sensor identification

The security indicator light flashes when the alarm system has been triggered. Also, the number of flashes indicates the location of unauthorized intrusion or the severity of impact on the vehicle.

- When the ignition switch is turned to the "ON" position, the indicator light will light for 1 second and then flash as follows:

When a door or rear gate was opened: 5 times

When the ignition switch was turned to the "ON" position by using a key not registered with your immobilizer system: 3 times

When a strong impact or multiple impacts were sensed: twice (only vehicles with shock sensors (dealer option))

When a light impact was sensed: once (only vehicles with shock sensors (dealer option))

■ Shock sensors (dealer option)

The shock sensors trigger the alarm system when they sense impacts applied to the vehicle and when any of their electric wires is cut. The alarm system causes the horn to sound and the turn

signal lights to flash for a short time when the sensed impact is weak, but it warns of a strong impact or multiple impacts by sounding the horn and flashing the turn signal lights, both lasting approximately 30 seconds.

If you desire, your SUBARU dealer can connect them and set them for activation or deactivation.

NOTE

- The shock sensors are not always able to sense impacts caused by breaking in, and cannot sense an impact that does not cause vibration (such as breaking the glass using a rescue hammer).
- The shock sensors may sense vibration like those shown in the following and trigger the alarm system. Select the settings of the alarm system and shock sensors appropriately depending on where you usually park your vehicle.

Example:

Vibration from construction site

Vibration in multistory car park

Vibration from trains

- You can have the sensitivity of the shock sensors adjusted to your preference by your SUBARU dealer.

Child safety locks

⚠ WARNING

Always use the child safety lock whenever a child rides in the rear. Serious injury could result if a child accidentally opened the door and fell out.

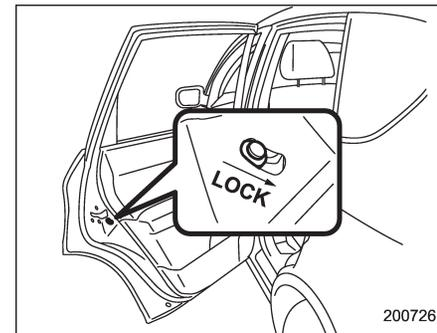

Each rear door has a child safety lock that prevents the doors from being opened even if the inside door handle is pulled.

When the child safety lock lever is in the lock position, the door cannot be opened from inside regardless of the position of the inner door handle lock lever. The door can only be opened from the outside.

Windows

■ Power windows

⚠ WARNING

To avoid serious personal injury caused by entrapment, you must do the following.

- When operating the power windows, be extremely careful to prevent anyone's fingers, arms, neck or head from being caught in the window.
- Always lock the passengers' windows using the lock switch when children are riding in the vehicle.
- Before leaving the vehicle, always remove the key from the ignition switch for safety and never allow an unattended child to remain in the vehicle. Failure to follow this procedure could result in injury to a child operating the power window.

The power windows operate only when the ignition switch is in the "ON" position.

▼ Driver's side switches

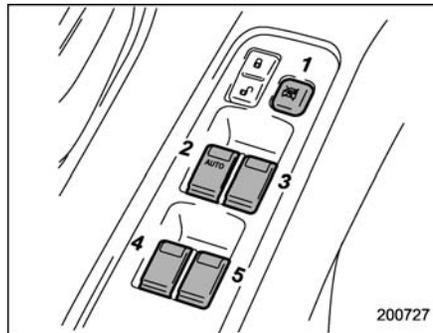

- 1) Lock switch
- 2) For driver's window
- 3) For front passenger's window
- 4) For rear left window
- 5) For rear right window

All door windows can be controlled by the power window switch cluster at the driver side door.

▽ Operating the driver's window

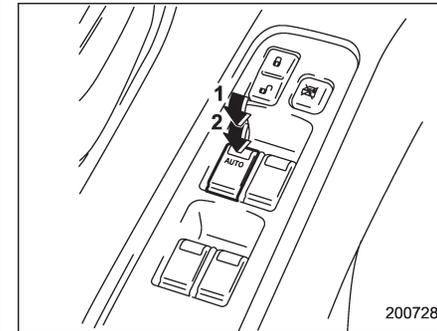

- 1) Open
- 2) Automatically open

To open:

Push the switch down lightly and hold it. The window will open as long as the switch is held.

This switch also has a one-touch auto down feature that allows the window to be opened fully without holding the switch.

Push the switch down until it clicks and release it, and the window will fully open. To stop the window halfway, pull the switch up lightly.

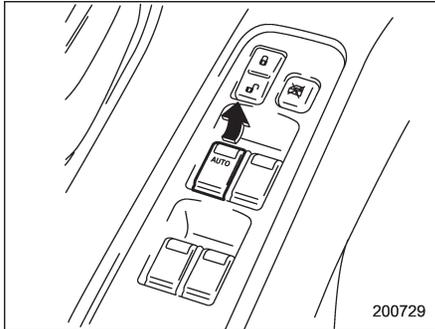

To close:
Pull the switch up lightly and hold it. The window will close as long as the switch is held.

▽ **Operating the passengers' windows**

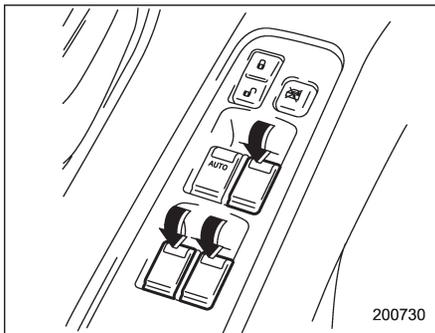

To open:
Push the appropriate switch down and hold it until the window reaches the desired position.

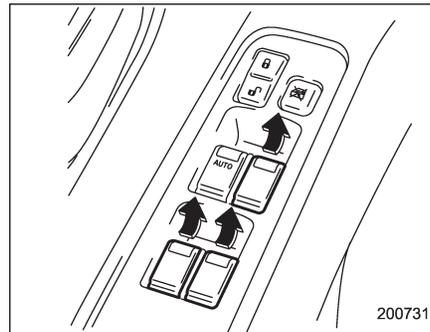

To close:
Pull the switch up and hold it until the window reaches the desired position.

▽ **Locking the passengers' windows**

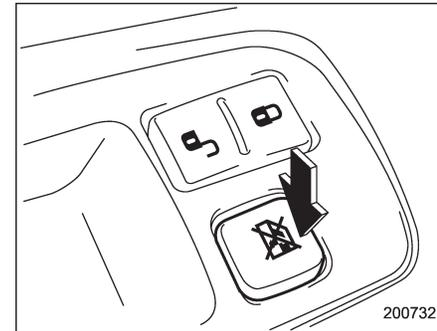

Push the lock switch. When the lock switch is in the "LOCK" position, the passengers' windows cannot be opened or closed.

Press the switch again to cancel the passengers' window locking.

NOTE

When the lock switch is pushed to the "LOCK" position, the indicator lights in the passenger's window switches (included in the power window switch cluster on the driver's door) all turn off.

▼ Passengers' side switches

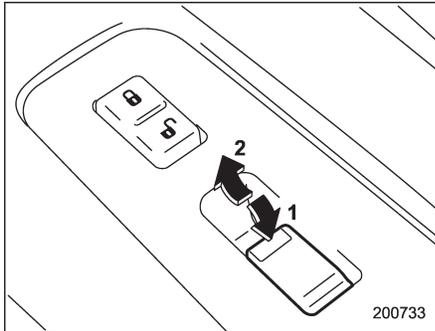

Front passenger's window switch

- 1) Open
- 2) Close

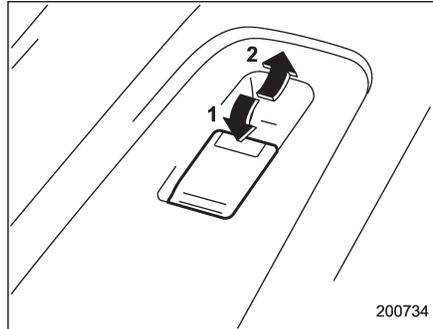

Rear passengers' window switches

- 1) Open
- 2) Close

To open:

Push the switch down and hold it until the window reaches the desired position.

To close:

Pull the switch up and hold it until the window reaches the desired position.

When the lock switch on the power window switch cluster, located on the driver's side door, is in the "LOCK" position, the passengers' windows cannot be operated with the passengers' switches.

Rear gate

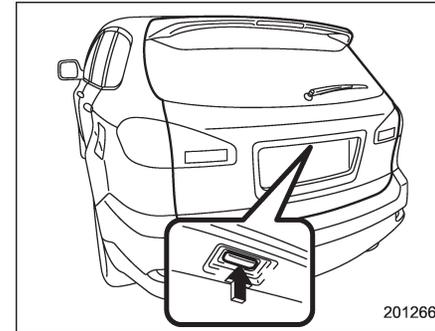

The rear gate can be locked and unlocked using either the remote keyless entry system or the power door locking switch. Refer to the "Power door locking switches" and "Remote keyless entry system" sections in this chapter.

To open:

First unlock the rear gate lock then push the button.

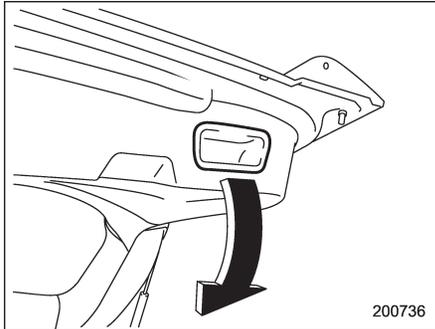
**To close:**

Lower the rear gate slowly and push down firmly until the latch engages.

The rear gate can be lowered easily if you pull it down holding the recessed grip.

WARNING

- To prevent dangerous exhaust gas from entering the vehicle, always keep the rear gate closed while driving.
- Do not attempt to shut the rear gate while holding the recessed grip. Also avoid closing the rear gate by pulling on the recessed grip from inside the cargo space. There is a danger of your hand being caught and injured.

CAUTION

- Do not jam a plastic bag in or place cellophane tape on the rear gate stays or scratch the stays while loading or unloading cargo. That could cause leakage of gas from the stays, which may result in their inability to hold the rear gate open.
- Be careful not to hit your head or face on the rear gate when opening or closing the rear gate and when loading or unloading cargo.

NOTE

Should the rear gate be unable to be unlocked due to a discharged battery, a malfunction in the door locking/unlocking system or other causes, you can unlock it by manually operating the rear gate lock release lever.

For the procedure, refer to “Rear gate – if the rear gate cannot be unlocked” section in chapter 9.

Moonroof (if equipped)

WARNING

- Never let anyone's hands, arms, head or any objects protrude from the moonroof. A person could be seriously injured if the vehicle stops suddenly or turns sharply or if the vehicle is involved in an accident.
To avoid serious personal injury caused by entrapment, you must do the following.
- Before closing the moonroof, make sure that no one's hands, arms, head or other objects will be accidentally caught in the moonroof.
- Before leaving the vehicle, always remove the key from the ignition switch for safety and never allow an unattended child to remain in the vehicle. Failure to follow this procedure could result in injury to a child operating the moonroof.

- Never try to check the anti-entrapment function by deliberately placing part of your body in the moonroof.

CAUTION

- Do not sit on the edge of the open moonroof.
- Do not operate the moonroof if falling snow or extremely cold conditions have caused it to freeze shut.
- The anti-entrapment function does not operate when the moonroof is being tilted down. Be sure to confirm that it is safe to do so before tilting the moonroof down.

The moonroof has both tilting and sliding functions.

The moonroof operates only when the ignition switch is in the "ON" position.

■ Tilt function

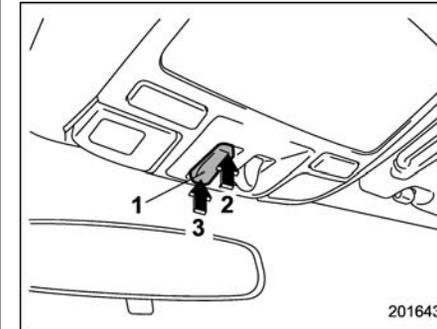

- 1) Tilt switch
- 2) Raise
- 3) Lower

The tilting function will only operate when the moonroof is fully closed.

Push the rear side of the "Tilt" switch to raise the moonroof.

Push the front side of the "Tilt" switch to lower the moonroof.

Release the switch after the moonroof has been raised or has been lowered completely. Pushing the switch continuously may cause damage to the moonroof.

NOTE

One-touch operation does not take place when the moonroof is raised or lowered. Push the switch continuously to raise or lower the moonroof.

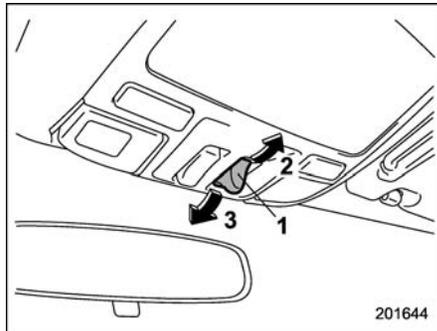
■ Sliding function

- 1) Open/Close switch
- 2) Open
- 3) Close

Push the "Open/Close" switch rearward to open the moonroof. The sun shade will also be opened together with the moonroof.

Push the "Open/Close" switch forward to close the moonroof. The moonroof will stop halfway. Push it again to close the moonroof completely.

To stop the moonroof at a selected midway position while opening or closing it, momentarily push the switch to the "OPEN" or "CLOSE" side.

After washing the vehicle or after it rains, wipe away water on the roof prior to opening the moonroof to prevent drops of water from falling into the passenger compartment.

■ Anti-entrapment function

When the moonroof senses an object trapped between its glass and the vehicle's roof during closure, it automatically moves back to either of the following positions according to the point at which it senses the object:

- When the moonroof senses the object at a point between the halfway stop position and fully closed position, it moves back to the halfway stop position and stops there.
- When the moonroof senses the object at a point between the halfway stop position and fully open position, it moves back to the fully open position and stops there.

The anti-entrapment function may also be activated by a strong shock on the moonroof even when there is nothing trapped.

NOTE

For the sake of safety, it is recommended that you avoid driving with the moonroof fully opened.

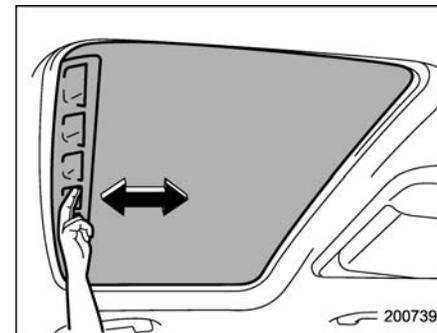
■ Sun shade

The sun shade can be slid forward or backward by hand while the moonroof is closed.

If the moonroof is opened, the sun shade also moves back.

Instruments and controls

<p>Ignition switch 3-3</p> <p> LOCK..... 3-3</p> <p> Acc..... 3-4</p> <p> ON..... 3-4</p> <p> START 3-4</p> <p> Key reminder chime 3-4</p> <p> Ignition switch light..... 3-4</p> <p>Hazard warning flasher..... 3-5</p> <p>Meters and gauges..... 3-5</p> <p> Combination meter illumination 3-5</p> <p> Canceling the function for meter needle/gauge movement and combination meter sequential illumination upon turning on the ignition switch..... 3-5</p> <p> Speedometer..... 3-6</p> <p> Odometer..... 3-6</p> <p> Double trip meter 3-7</p> <p> Tachometer 3-7</p> <p> Fuel gauge..... 3-8</p> <p> Temperature gauge 3-9</p> <p>Warning and indicator lights 3-9</p> <p> Seatbelt warning light and chime 3-10</p> <p> SRS airbag system warning light..... 3-11</p> <p> Front passenger's frontal airbag ON and OFF indicators..... 3-12</p> <p> CHECK ENGINE warning light/Malfunction indicator lamp..... 3-12</p> <p> Charge warning light..... 3-13</p> <p> Oil pressure warning light 3-13</p> <p> AT OIL TEMP warning light 3-13</p>	<p> Rear differential oil temperature warning light 3-14</p> <p> Low tire pressure warning light..... 3-14</p> <p> ABS warning light..... 3-15</p> <p> Brake system warning light..... 3-16</p> <p> Low fuel warning light 3-17</p> <p> Door open warning light 3-17</p> <p> Windshield washer fluid warning light 3-18</p> <p> All-Wheel Drive warning light 3-18</p> <p> Vehicle Dynamics Control operation indicator light 3-18</p> <p> Vehicle Dynamics Control warning light/Traction Control system OFF indicator light..... 3-18</p> <p> Security indicator light..... 3-19</p> <p> SPORT mode indicator light..... 3-20</p> <p> Selector lever/Gear position indicator 3-20</p> <p> Turn signal indicator lights..... 3-20</p> <p> High beam indicator light..... 3-20</p> <p> Cruise control indicator light..... 3-20</p> <p> Cruise control set indicator light 3-21</p> <p> Headlight indicator light..... 3-21</p> <p> Front fog light indicator light..... 3-21</p> <p> Clock 3-21</p> <p> Outside temperature indicator 3-22</p> <p> Low outside temperature warning 3-22</p> <p> Multi function display (vehicles without a genuine SUBARU navigation system)..... 3-23</p> <p> Current fuel consumption 3-23</p> <p> Average fuel consumption 3-24</p> <p> Driving range on remaining fuel 3-24</p> <p> Journey time 3-25</p>
--	--

Instruments and controls

Light control switch	3-26
Headlights	3-26
High/low beam change (dimmer)	3-27
Headlight flasher	3-27
Daytime running light system	3-27
Turn signal lever	3-28
Illumination brightness control	3-28
Headlight beam leveler (if equipped)	3-29
For 5-seater models	3-30
For 7-seater models	3-31
Parking light switch	3-32
Front fog light switch	3-32

Wiper and washer	3-33
Windshield wiper and washer switches	3-34
Rear window wiper and washer switch	3-35
Windshield wiper deicer	3-36
Rear window defogger button	3-37
Mirrors	3-38
Inside mirror	3-38
Auto-dimming mirror/compass (if equipped)	3-38
Outside mirrors	3-39
Tilt steering wheel	3-41
Horn	3-42

Ignition switch

WARNING

- Never turn the ignition switch to “LOCK” while the vehicle is being driven or towed because that will lock the steering wheel, preventing steering control. And when the engine is turned off, it takes a much greater effort than usual to steer.
- Before leaving the vehicle, always remove the key from the ignition switch for safety and never allow an unattended child to remain in the vehicle. Failure to follow this procedure could result in injury to a child or others. Children could operate the power windows, the moon-roof or other controls or even make the vehicle move.

CAUTION

Do not attach a large key holder or key case to either key. If it banged against your knees or hands while you were driving, it could turn the ignition switch from the “ON” posi-

tion to the “Acc” or “LOCK” position, thereby stopping the engine. Also, if the key is attached to a keyholder or to a large bunch of other keys, centrifugal force may act on it as the vehicle moves, resulting in unwanted turning of the ignition switch.

The ignition switch has four positions: LOCK, Acc, ON and START.

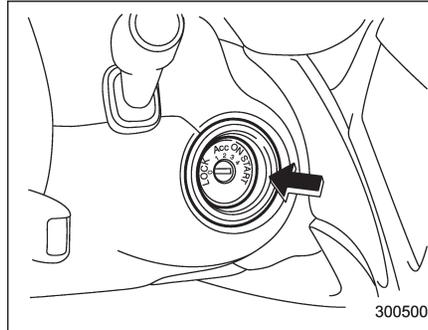

NOTE

- Keep the ignition switch in the “LOCK” position when the engine is not running.
- Using electrical accessories for a long time with the ignition switch in the “ON” or “Acc” position can cause the battery to go dead.

- If the ignition switch will not move from the “LOCK” position to the “Acc” position, turn the steering wheel slightly to the left and right as you turn the ignition switch.

LOCK

The key can only be inserted or removed in this position. The ignition switch will lock the steering wheel when you remove the key.

If turning the key is difficult, turn the steering wheel slightly to the right and left as you turn the key.

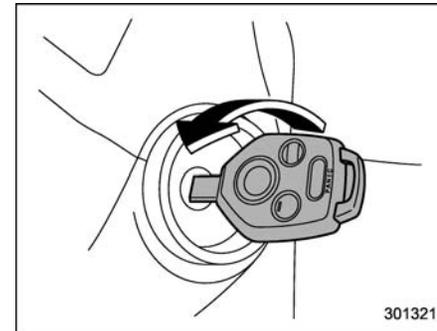

The key can be turned from “Acc” to “LOCK” only when the selector lever is in the “P” position.

– CONTINUED –

3-4 Instruments and controls

■ Acc

In this position the electrical accessories (radio, accessory power outlet, etc.) can be used.

■ ON

This is the normal operating position after the engine is started.

■ START

⚠ CAUTION

Do not turn the ignition switch to the "START" position while the engine is running.

The engine is started in this position. The starter cranks the engine to start it. When the key is released (after the engine has started), the key automatically returns to the "ON" position.

If your registered key fails to start the engine, pull out the key once (the security indicator light will blink), and then insert the key in the ignition switch and turn it to the "START" position and again try to start the engine.

NOTE

The engine may not start in the following cases:

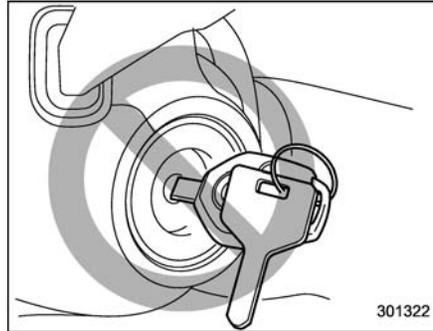

- The key grip is touching another key or a metallic key holder.

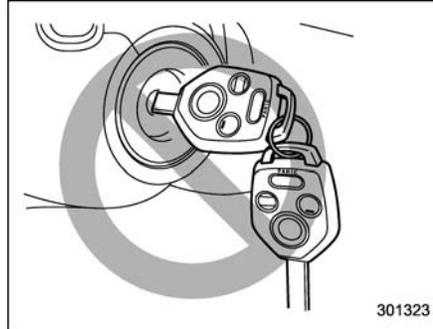

- The key is near another key that

contains an immobilizer transponder.

- The key is near or touching another transmitter.

■ Key reminder chime

The reminder chime sounds when the driver's door opens and the key is in the "LOCK" or "Acc" positions. The chime stops when the key is removed from the ignition switch.

■ Ignition switch light

For easy access to the ignition switch in the dark, the ignition switch light illuminates when the driver's door is opened. The light remains illuminated for a several seconds and gradually turns off after the driver's door is closed.

Hazard warning flasher

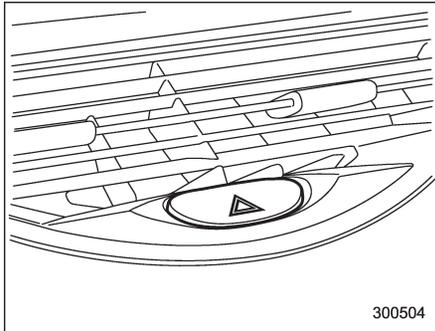

300504

The hazard warning flasher is used to warn other drivers when you have to park your vehicle under emergency conditions. The hazard warning flasher works with the ignition switch in any position.

To turn on the hazard warning flasher, push the hazard warning button on the instrument panel. To turn off the flasher, push the button again.

NOTE

When the hazard warning flasher is on, the turn signals do not work.

Meters and gauges

NOTE

Liquid-crystal displays are used in some of the meters and gauges on the combination meter. You will find their indications hard to see if you wear polarized glasses.

■ Combination meter illumination

When the ignition switch is turned to the "ON" position, the various parts of the combination meter are illuminated in the following sequence:

1. Warning lights, indicator lights, meter rims, meter needles, odometer, trip meter, and gauge back lights illuminate.
2. Meter needles and gauges each show MAX reading.
3. Meter needles and gauges each show MIN reading.
4. Meter and gauge dials illuminate.
5. Regular illumination (for driving) begins.

NOTE

The above sequence of operations may not take place if you quickly turn the

ignition switch to start the engine. This is not a malfunction.

- **Canceling the function for meter needle/gauge movement and combination meter sequential illumination upon turning on the ignition switch**

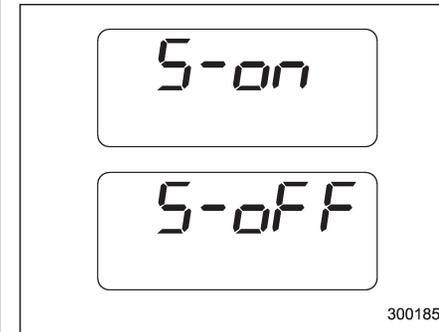

300185

It is possible to activate or deactivate the movement of the meter needles and gauges and sequential illumination of the combination meter that takes place when the ignition switch is turned to the "ON" position.

Turn the ignition switch to the "Acc" position. With the A trip meter indication selected, briefly press the trip knob twice. You can now establish the activated/deactivated setting for movement of the

– CONTINUED –

3-6 Instruments and controls

meter needles and gauges when the ignition switch is turned to the “ON” position. To change the current setting, press the trip knob for at least 2 seconds.

S-on : Activated
S-off : Deactivated

With the function deactivated, the combination meter illuminates as follows:

1. Warning lights, indicator lights, meter rims, meter needles, odometer, trip meter, and gauge back lights illuminate.
2. Meter and gauge dials illuminate.
3. Regular illumination (for driving) begins.

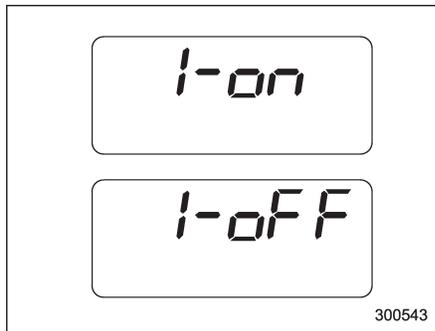

Briefly press the trip knob again. You can now establish the activated/deactivated setting for sequential illumination of the

combination meter when the ignition switch is turned to the “ON” position. To change the current setting, press the trip knob for at least 2 seconds.

I-on : Activated
I-off : Deactivated

Briefly press the knob to return to the A trip meter indication.

If you turn the ignition switch to the “LOCK” position, turn the ignition switch to the “ON” position, or open and close the driver’s door during the setting procedure, the new setting will be canceled.

Also, if you do not press the trip knob for a period of 10 seconds, the new setting will be canceled.

NOTE

- It is not possible to cancel sequential illumination of the combination meter while sequential illumination is actually taking place. Cancel sequential illumination when regular illumination (for driving) has begun.
- When you open the driver’s door with the ignition switch in the “LOCK” position, the meters’ needles and rims are lit. The illumination stops working when you shut the driver’s door or automatically after 30 seconds.

Speedometer

The speedometer shows the vehicle speed.

Odometer

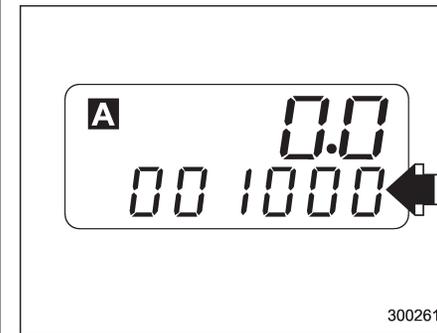

This meter displays the odometer when the ignition switch is in the “LOCK”, “Acc” or “ON” position.

The odometer shows the total distance that the vehicle has been driven.

If you press the trip knob when the ignition switch is in the “LOCK” or “Acc” position, the odometer/trip meter will light up. If you do not press the trip knob within 10 seconds of illumination of the odometer/trip meter, the odometer/trip meter will turn off.

The odometer/trip meter will also turn off if you open and close the driver's door within 10 seconds of illumination of the odometer/trip meter.

■ **Double trip meter**

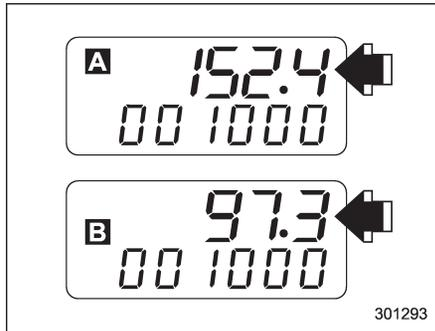

This meter displays two trip meters when the ignition switch is in the "LOCK", "Acc" or "ON" position.

The trip meter shows the distance that the vehicle has been driven since you last set it to zero.

To change the mode indication, briefly push the knob.

Each press of the knob changes the mode indication alternately.

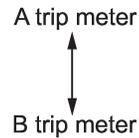

To set the trip meter to zero, select the A trip or B trip meter by pushing the knob and keep the knob pushed for more than 2 seconds.

If you press the trip knob when the ignition switch is in the "LOCK" position, the odometer/trip meter will light up. It is possible to switch between the A trip meter and B trip meter indications while the odometer/trip meter is lit up. If you do not press the trip knob within 10 seconds of illumination of the odometer/trip meter, the odometer/trip meter will turn off. Also, if you open and close the driver's door within 10 seconds of illumination of the odometer/trip meter, the odometer/trip meter will turn off.

CAUTION

To ensure safety, do not attempt to change the function of the indicator during driving, as an accident could result.

NOTE

If the connection between the combination meter and battery is broken for any reason such as vehicle maintenance or fuse replacement, the data recorded on the trip meter will be lost.

▼ **Vehicle communication system malfunction indication**

The vehicle communication system carries various types of information (vehicle speed, running conditions, etc.) to control modules. In the event of a malfunction in this communication system, the trip meter will show "E-∞".

If the trip meter shows "E-∞", immediately contact the nearest SUBARU dealer and have the vehicle communication system inspected.

NOTE

If you press the trip knob while the trip meter is showing "E-∞", the trip meter indication will appear for 10 seconds.

■ **Tachometer**

The tachometer shows the engine speed in thousands of revolutions per minute.

CAUTION

Do not operate the engine with the

- CONTINUED -

pointer of the tachometer in the red zone. In this range, fuel injection will be cut by the engine control module to protect the engine from overrevving. The engine will resume running normally after the engine speed is reduced below the red zone.

■ Fuel gauge

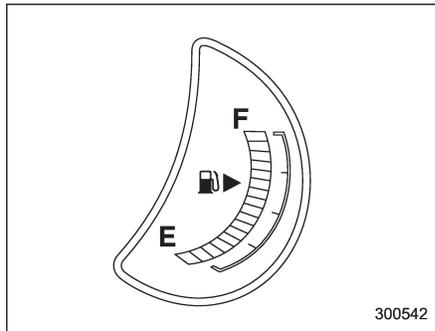

The fuel gauge shows the approximate amount of fuel remaining in the tank.

The gauge may move slightly during braking, turning or acceleration due to fuel level movement in the tank.

If you press the trip knob while the ignition switch is in the "LOCK" or "Acc" position, the fuel gauge will light up and indicate the

amount of fuel remaining in the tank.

If, while the fuel gauge is indicating the amount of fuel remaining in the tank, you (a) do not press the trip knob for 10 seconds or (b) open and close the driver's door, the fuel gauge indication will turn off.

NOTE

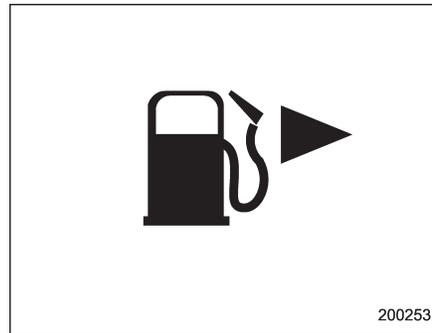

You will see the "▶" sign in the fuel gauge meter.

This indicates that the fuel filler door (lid) is located on the right side of the vehicle.

▼ Low fuel warning light



⚠ CAUTION

Promptly put fuel in the tank whenever the low fuel warning light illuminates. Engine misfires as a result of an empty tank could cause damage to the engine.

The low fuel warning light illuminates when the tank is nearly empty [approximately 2.6 US gal (10 liters, 2.2 Imp gal)].

It only operates when the ignition switch is in the "ON" position. When this light illuminates, fill the fuel tank immediately.

NOTE

This light does not turn off unless the tank is replenished up to an internal fuel quantity of approximately 4.0 US gal (15 liters, 3.3 Imp gal).

■ Temperature gauge

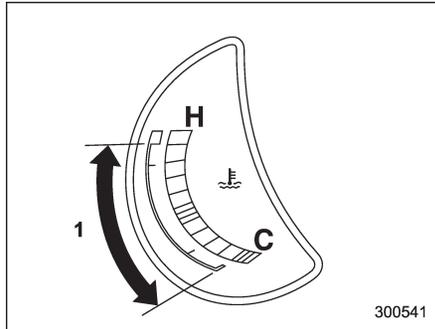

1) Normal operating range

The temperature gauge shows engine coolant temperature when the ignition switch is in the "ON" position.

The coolant temperature will vary in accordance with the outside temperature and driving conditions.

We recommend that you drive moderately until the pointer of the temperature gauge reaches near the middle of the range. Engine operation is optimum with the engine coolant at this temperature range. Also, high revving operation while the engine is not sufficiently warmed up should be avoided.

⚠ CAUTION

If the pointer exceeds the normal operating range, safely stop the vehicle as soon as possible.

Refer to "In case of emergency" in chapter 9.

Warning and indicator lights

Several of the warning and indicator lights illuminate momentarily and then turn off when the ignition switch is initially turned to the "ON" position. This permits checking the operation of the bulbs.

Apply the parking brake and turn the ignition switch to the "ON" position. The following lights illuminate:

 Driver's seatbelt warning light
(The seatbelt warning light turns off only when the driver fastens the seatbelt.)

PASS  Front passenger's seatbelt warning light
(The seatbelt warning light turns off only when the front seat passenger fastens the seatbelt.)

AIR BAG  SRS airbag system warning light

CHECK ENGINE  CHECK ENGINE warning light/Malfunction indicator lamp

 Charge warning light

 Oil pressure warning light

AT OIL TEMP  AT OIL TEMP warning light

ABS /  ABS warning light

 Vehicle Dynamics Control operation

– CONTINUED –

3-10 Instruments and controls

indicator light

: Vehicle Dynamics Control warning light/Traction Control system OFF indicator light

: Brake system warning light

: All-Wheel Drive warning light

: Low tire pressure warning light

: SPORT mode indicator light

: Front passenger's frontal airbag ON indicator light

: Front passenger's frontal airbag OFF indicator light

: Low fuel warning light

: Cruise control indicator light

: Cruise control set indicator light

: Rear differential oil temperature warning light

: Windshield washer fluid warning light

: Door open warning light

If any lights do not illuminate, it indicates a burned-out bulb or a malfunction of the corresponding system.

Consult your authorized SUBARU dealer for repair.

■ Seatbelt warning light and chime

Your vehicle is equipped with a seatbelt warning device at the driver's and front passenger's seat.

With the ignition switch turned to the "ON" position, this device reminds the driver and front passenger to fasten their seatbelts by illuminating the warning lights in the locations indicated in the following illustrations and sounding a chime.

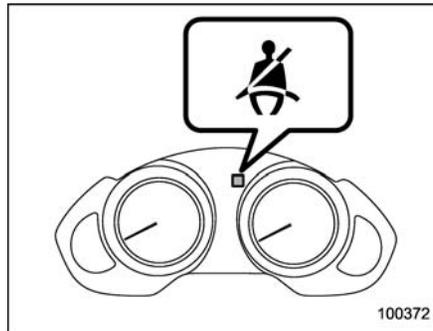

Driver's warning light

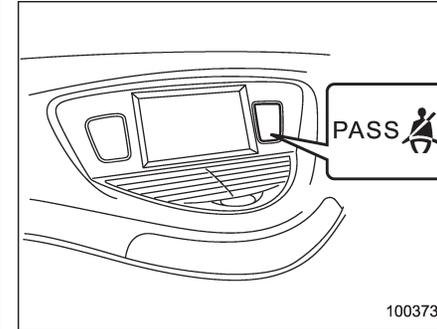

Front passenger's warning light

▼ Operation

If the driver and/or front passenger have/has not yet fastened the seatbelt(s) when the ignition switch is turned to the "ON" position, the seatbelt warning light(s) will flash for 6 seconds, to warn that the seatbelt(s) is/are unfastened. If the driver's seatbelt is not fastened, a chime will also sound simultaneously.

NOTE

- If the driver's and/or front passenger's seatbelt(s) is/are still not fastened 6 seconds later, the seatbelt warning device operates as follows according to the vehicle speed.
 - At speeds lower than approximately 9 mph (15 km/h)

The warning light(s) for unfastened seatbelt(s) will alternate between steady illumination and flashing at 15-second intervals. The chime will not sound.

- At speeds higher than approximately 9 mph (15 km/h)

The warning light(s) for unfastened seatbelt(s) will alternate between flashing and steady illumination at 15-second intervals and the chime will sound while the warning light(s) is/are flashing.

- It is possible to cancel the warning operation that follows the 6-second warning after turning ON the ignition switch. When the ignition switch is turned ON next time, however, the complete sequence of the warning operation resumes. For further details about canceling the warning operation, please contact your SUBARU dealer.

If there is no passenger on the front passenger's seat, the seatbelt warning device for the front passenger's seat will be deactivated. The front passenger's occupant detection system monitors whether or not there is a passenger on the front passenger's seat. Observe the following precautions. Failure to do so may prevent the device from functioning correctly or cause the device to fail.

- Do not install any accessory such as a table or TV onto the seatback.
- Do not store a heavy load in the seatback pocket.
- Do not allow the rear seat occupant to place his/her hands or legs on the front passenger's seatback, or allow him/her to pull the seatback.

If the seatbelt warning device for the front passenger's seat does not function correctly (e.g., it is activated even when the front passenger's seat is empty or it is deactivated even when the front passenger has not fastened his/her seatbelt), take the following actions.

- Ensure that no article is placed on the seat other than a child restraint system and its child occupant.
- Ensure that there is no article left in the seatback pocket.

If still the seatbelt warning device for front passenger's seat does not function correctly after taking relevant corrective actions described above, immediately contact your SUBARU dealer for an inspection.

■ SRS airbag system warning light

AIR
BAG

When the ignition switch is turned to the "ON" position, the SRS airbag system warning light will illuminate for approximately 6 seconds and turn off. This shows the SRS frontal airbag and SRS side airbag and SRS curtain airbag and seatbelt pretensioners are in normal operation.

WARNING

If the warning light exhibits any of the following conditions, there may be a malfunction in the seatbelt pretensioners and/or SRS airbag system. Immediately take your vehicle to your nearest SUBARU dealer to have the system checked. Unless checked and properly repaired, the seatbelt pretensioners and/or SRS airbags will operate improperly (e.g. SRS airbags may inflate in a very minor collision or not inflate in a severe collision), which may increase the risk of injury.

- Flashing or flickering of the warning light
- No illumination of the warning light when the ignition switch is first turned to the "ON" position

– CONTINUED –

- Continuous illumination of the warning light
- Illumination of the warning light while driving

■ Front passenger's frontal airbag ON and OFF indicators

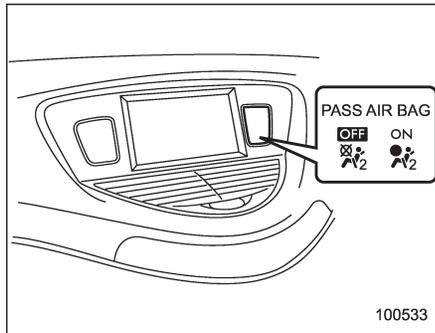

- ON : Front passenger's frontal airbag ON indicator
- OFF : Front passenger's frontal airbag OFF indicator

The front passenger's frontal airbag ON and OFF indicators show you the status of the front passenger's SRS frontal airbag. The indicators are located in the center portion of the dashboard.

When the ignition switch is turned to the "ON" position, both the ON and OFF indicators illuminate for 6 seconds during which time the system is checked. Following the system check, both indicators turn off for 2 seconds. After that, one of the indicators illuminates depending on the status of the front passenger's SRS frontal airbag determined by the SUBARU advanced frontal airbag system monitoring. If the front passenger's SRS frontal airbag is activated, the passenger's frontal airbag ON indicator will illuminate while the OFF indicator will remain off.

If the front passenger's SRS frontal airbag is deactivated, the passenger's frontal airbag ON indicator will remain off while the OFF indicator will illuminate.

If both the ON and OFF indicators remain illuminated or off simultaneously, the system is malfunctioning. Contact your SUBARU dealer immediately for an inspection.

■ CHECK ENGINE warning light/Malfunction indicator lamp

⚠ CAUTION

If the CHECK ENGINE light illuminates while you are driving, have your vehicle checked/repaired by your SUBARU dealer as soon as possible. Continued vehicle operation without having the emission control system checked and repaired as necessary could cause serious damage, which may not be covered by your vehicle's warranty.

If this light illuminates steadily or blinks while the engine is running, it may indicate that there is a problem or potential problem somewhere in the emission control system.

▼ If the light illuminates steadily:

If the light illuminates steadily while driving or does not turn off after the engine starts, an emission control system malfunction has been detected.

You should have your vehicle checked by an authorized SUBARU dealer immediately.

NOTE

This light also illuminates when the fuel filler cap is not tightened until it clicks.

If you have recently refueled your vehicle, the cause of the CHECK ENGINE warning light/malfunction indicator lamp illuminating could be a loose or missing fuel filler cap. Remove the cap and retighten it until it clicks. Make sure nothing is interfering with the sealing of the cap. Tightening the cap will not make the CHECK ENGINE warning light turn off immediately. It may take several driving trips. If the light does not turn off, take your vehicle to your authorized SUBARU dealer immediately.

▼ **If the light is blinking:**

If the light is blinking while driving, an engine misfire condition has been detected which may damage the emission control system.

To prevent serious damage to the emission control system, you should do the following.

- Reduce vehicle speed.
- Avoid hard acceleration.
- Avoid steep uphill grades.
- Reduce the amount of cargo, if possible.
- Stop towing a trailer as soon as possible.

The CHECK ENGINE warning light may stop blinking and illuminate steadily after several driving trips. You should have your vehicle checked by an authorized SUBARU dealer immediately.

■ **Charge warning light**



If this light illuminates when the engine is running, it may indicate that the charging system is not working properly.

If the light illuminates while driving or does not turn off after the engine starts, stop the engine at the first safe opportunity and check the alternator belt. If the belt is loose, broken or if the belt is in good condition but the light remains illuminated, contact your nearest SUBARU dealer immediately.

■ **Oil pressure warning light**



CAUTION

Do not operate the engine with the oil pressure warning light illuminated. This may cause serious engine damage.

If this light illuminates when the engine is running, it may indicate that the engine oil pressure is low and the lubricating system

is not working properly.

If the light illuminates while driving or does not turn off after the engine starts, stop the engine at the first safe opportunity and check the engine oil level. If the oil level is low, add oil immediately. If the engine oil is at the proper level but the light remains illuminated, contact your nearest SUBARU dealer immediately.

■ **AT OIL TEMP warning light**

AT OIL TEMP

The AT oil temperature warning light "AT OIL TEMP" illuminates when the ignition switch is turned to the "ON" position and turns off after approximately 2 seconds.

If this light illuminates when the engine is running, it may indicate that the automatic transmission fluid temperature is too hot.

If the light illuminates while driving, immediately stop the vehicle in a safe place and let the engine idle until the warning light turns off.

▼ **Automatic transmission control system warning**

If the light flashes after the engine starts, it may indicate that the automatic transmission control system is not working properly. Contact your nearest SUBARU dealer for service immediately.

– CONTINUED –

■ **Rear differential oil temperature warning light**

R.DIFF
TEMP



Reduce vehicle speed and park the vehicle in a safe place as soon as possible if the R.DIFF TEMP light illuminates. Continued driving with this light illuminated can damage the rear differential and other parts of the powertrain.

If this light illuminates when the engine is running, it may indicate that the rear differential oil temperature is too hot.

If the light illuminates while driving, reduce vehicle speed and stop the vehicle at the nearest safe place.

Park the vehicle for several minutes. After the light turns off, you can start driving.

If the light does not turn off, contact the nearest SUBARU dealer for service.

NOTE

● **If the tire pressures are not correct and/or the tires are not all the same size and brand, the rear differential will be heavily loaded when the vehicle is driven, resulting in an abnormally high oil temperature.**

● **The rear differential oil will deteriorate if its temperature increases enough for the rear differential oil temperature warning light to illuminate. It is advisable to have the rear differential oil replaced as soon as possible.**

■ **Low tire pressure warning light**



When the ignition switch is turned to the "ON" position, the low tire pressure warning light will illuminate for approximately 2 seconds to check that the tire pressure monitoring system (TPMS) is functioning properly. If there is no problem and all tires are properly inflated, the light will turn off. Each tire, including the spare (if provided), should be checked monthly when cold and inflated to the inflation pressure recommended by the vehicle manufacturer on the vehicle placard or tire inflation pressure label. (If your vehicle has tires of a different size than the size indicated on the vehicle placard or tire inflation pressure label, you should determine the proper inflation pressure for those tires.)

As an added safety feature, your vehicle has been equipped with a tire pressure monitoring system (TPMS) that illuminates a low tire pressure telltale when one or more of your tires is significantly under-

inflated. Accordingly, when the low tire pressure telltale illuminates, you should stop and check your tires as soon as possible, and inflate them to the proper pressure. Driving on a significantly under-inflated tire causes the tire to overheat and can lead to tire failure. Under-inflation also reduces fuel efficiency and tire tread life, and may affect the vehicle's handling and stopping ability.

Please note that the TPMS is not a substitute for proper tire maintenance, and it is the driver's responsibility to maintain correct tire pressure, even if under-inflation has not reached the level to trigger illumination of the TPMS low tire pressure telltale.

Your vehicle has also been equipped with a TPMS malfunction indicator to indicate when the system is not operating properly. The TPMS malfunction indicator is combined with the low tire pressure telltale. When the system detects a malfunction, the telltale will flash for approximately one minute and then remain continuously illuminated. This sequence will continue upon subsequent vehicle start-ups as long as the malfunction exists. When the malfunction indicator is illuminated, the system may not be able to detect or signal low tire pressure as intended. TPMS malfunctions may occur for a variety of

reasons, including the installation of replacement or alternate tires or wheels on the vehicle that prevent the TPMS from functioning properly. Always check the TPMS malfunction telltale after replacing one or more tires or wheels on your vehicle to ensure that the replacement or alternate tires and wheels allow the TPMS to continue to function properly.

Should the warning light illuminate steadily after blinking for approximately one minute, have the system inspected by your nearest SUBARU dealer as soon as possible.

 **WARNING**

If this light does not illuminate briefly after the ignition switch is turned ON or the light illuminates steadily after blinking for approximately one minute, you should have your Tire Pressure Monitoring System checked at a SUBARU dealer as soon as possible.

If this light illuminates while driving, never brake suddenly and keep driving straight ahead while gradually reducing speed. Then slowly pull off the road to a safe place. Otherwise an accident involving serious vehicle damage and serious

personal injury could occur.

If this light still illuminates while driving after adjusting the tire pressure, a tire may have significant damage and a fast leak that causes the tire to lose air rapidly. If you have a flat tire, replace it with a spare tire as soon as possible.

When a spare tire is mounted or a wheel rim is replaced without the original pressure sensor/transmitter being transferred, the Low tire pressure warning light will illuminate steadily after blinking for approximately one minute. This indicates the TPMS is unable to monitor all four road wheels. Contact your SUBARU dealer as soon as possible for tire and sensor replacement and/or system resetting. If the light illuminates steadily after blinking for approximately one minute, promptly contact a SUBARU dealer to have the system inspected.

 **CAUTION**

The tire pressure monitoring system is NOT a substitute for manually checking tire pressure. The tire pressure should be checked peri-

odically (at least monthly) using a tire gauge. After any change to tire pressure(s), the tire pressure monitoring system will not re-check tire inflation pressures until the vehicle is first driven more than 20 mph (32 km/h). Therefore, after adjusting the tire pressures, increase the vehicle speed to at least 20 mph (32 km/h) to start the TPMS re-checking of the tire inflation pressures. If the tire pressures are now above the severe low pressure threshold, the low tire pressure warning light should turn off a few minutes later. Therefore, be sure to install the specified size for the front and rear tires.

 **ABS warning light**

ABS (U.S.)
 (concept U.S.)

The ABS warning light illuminates when the ignition switch is turned to the "ON" position and turns off after approximately 2 seconds.

This is an indication that the ABS system is working properly.

 **CAUTION**

If the warning light behaves as follows, the ABS system may not work properly.

When the warning light illuminates, the ABS function shuts down; however, the conventional brake system continues to operate normally.

- The warning light does not illuminate when the ignition switch is turned to the “ON” position.
- The warning light illuminates when the ignition switch is turned to the “ON” position, but it does not turn off even when the vehicle speed exceeds approximately 8 mph (12 km/h).
- The warning light illuminates during driving.

If any of these conditions occur, have the ABS system repaired at the first available opportunity by your SUBARU dealer.

The ABS warning light illuminates together with the brake system warning light if the EBD system becomes malfunctioning. For further details of the EBD system malfunction warning, refer to “Brake system warning light”.

NOTE

If the warning light behavior is as described in the following, the ABS system may be considered normal.

- The warning light illuminates right after the engine is started but turns off immediately, remaining off.
- The warning light remains illuminated after the engine has been started, but it turns off when the vehicle speed reaches approximately 8 mph (12 km/h).
- The warning light illuminates during driving, but it turns off immediately and remains off.

When driving with an insufficient battery voltage such as when the engine is jump started, the ABS warning light may illuminate. This is due to the low battery voltage and does not indicate a malfunction. When the battery becomes fully charged, the light will turn off.

■ Brake system warning light

BRAKE (U.S.)
(Ⓢ)(except U.S.)

▲ WARNING

- Driving with the brake system warning light illuminated is dangerous. This indicates your brake system may not be working properly. If the light remains illuminated, have the brakes inspected by a SUBARU dealer immediately.

- If at all in doubt about whether the brakes are operating properly, do not drive the vehicle. Have your vehicle towed to the nearest SUBARU dealer for repair.

This light has the following three functions:

▼ Parking brake warning

The light illuminates with the parking brake applied while the ignition switch is in the “ON” position. It turns off when the parking brake is fully released.

▼ Brake fluid level warning

This light illuminates when the brake fluid level has dropped to near the “MIN” level of the brake fluid reservoir with the ignition switch in the “ON” position and with the parking brake fully released.

If the brake system warning light should illuminate while driving (with the parking brake fully released and with the ignition switch positioned in “ON”), it could be an indication of leaking of brake fluid or worn brake pads. If this occurs, immediately stop the vehicle at the nearest safe place and check the brake fluid level. If the fluid level is below the “MIN” mark in the reservoir, do not drive the vehicle. Have the vehicle towed to the nearest SUBARU

dealer for repair.

▼ Electronic Brake Force Distribution (EBD) system warning

The brake system warning light also illuminates if a malfunction occurs in the EBD system. In that event, it illuminates together with the ABS warning light.

The EBD system may be malfunctioning if the brake system warning light and ABS warning light illuminate simultaneously during driving.

Even if the EBD system fails, the conventional braking system will still function. However, the rear wheels will be more prone to locking when the brakes are applied harder than usual and the vehicle's motion may therefore become somewhat harder to control.

If the brake system warning light and ABS warning light illuminate simultaneously, take the following steps:

1. Stop the vehicle in the nearest safe, flat place.
2. Shut down the engine, apply the parking brake, and then restart it.
3. Release the parking brake. If both warning lights turn off, the EBD system may be malfunctioning.

Drive carefully to the nearest SUBARU dealer and have the system inspected.

4. If both warning lights illuminate again

and remain illuminated after the engine has been restarted, shut down the engine again, apply the parking brake, and check the brake fluid level.

5. If the brake fluid level is not below the "MIN" mark, the EBD system may be malfunctioning. Drive carefully to the nearest SUBARU dealer and have the system inspected.

6. If the brake fluid level is below the "MIN" mark, DO NOT drive the vehicle. Instead, have the vehicle towed to the nearest SUBARU dealer for repair.

■ Low fuel warning light



▲ CAUTION

Immediately put fuel in the tank whenever the low fuel warning light illuminates. Engine misfires as a result of an empty tank could cause damage to the engine.

The low fuel warning light illuminates when the tank is nearly empty approximately 2.6 US gal (10 liters, or 2.2 Imp gal). It only operates when the ignition switch is in the "ON" position. When this light illuminates, fill the fuel tank immediately.

NOTE

This light does not turn off unless the tank is replenished up to an internal fuel quantity of approximately 4.0 US gal (15 liters, 3.3 Imp gal).

■ Door open warning light

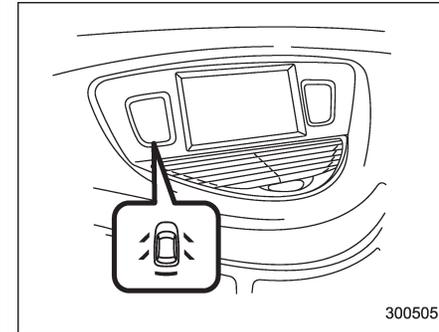

The indicators are located in the center portion of the dashboard.

When any of the doors or the rear gate is not fully closed, it is indicated by the corresponding part of the door open warning light.

Always make sure this light is out before you start to drive.

– CONTINUED –

■ Windshield washer fluid warning light



This light illuminates when the fluid level in the windshield washer fluid tank falls to the lower limit (approximately 0.6 US qt, 0.6 liter, 0.5 Imp qt).

■ All-Wheel Drive warning light **AWD**



WARNING

Continued driving with the AWD warning light flashing can lead to powertrain damage. If the AWD warning light flashes, promptly park in a safe place then check whether all four tires are the same diameter and whether any of the tires has a puncture or has lost air pressure for some other reason.

The All-Wheel Drive warning light illuminates when the ignition switch is turned to the "ON" position and turns off after the engine has started.

This light flashes if the vehicle is driven with tires of different diameters fitted on its wheels or with the air pressure excessively low in any of its tires.

■ Vehicle Dynamics Control operation indicator light



This light illuminates when the ignition switch is ON and turns off approximately 2 seconds later.

It blinks when the skid suppression function is activated. It illuminates when only the traction control function is operating.

The Vehicle Dynamics Control system is probably malfunctioning under any of the following conditions. Have your vehicle checked at a SUBARU dealer immediately.

- The light does not illuminate when the ignition switch is turned to the "ON" position.
- The light does not turn off even after a period of approximately 2 seconds after the ignition switch has been turned to the "ON" position.

■ Vehicle Dynamics Control warning light/ Traction Control system OFF indicator light



This warning light has both the function of indicating malfunctions in the Vehicle Dynamics Control system and the function of indicating that the Traction Control

system has been deactivated.

It illuminates in the event of a malfunction in the system or when the system is not operating.

This warning light illuminates when the ignition switch is turned to the "ON" position and turns off several seconds after engine startup. It indicates that the Vehicle Dynamics Control system is in normal operation.

▼ Vehicle Dynamics Control warning light

The Vehicle Dynamics Control system is probably inoperative under any of the following conditions. Have your vehicle checked at a SUBARU dealer immediately.

- The warning light does not illuminate when the ignition switch is turned to the "ON" position.
- The warning light illuminates while the vehicle is running.
- If the electrical circuit of the Vehicle Dynamics Control system itself becomes malfunctioning, the warning light only illuminates. At this time, the ABS (Anti-lock Brake System) remains fully operational.
- The warning light illuminates when the electronic control system of the ABS/ Vehicle Dynamics Control system be-

comes malfunctioning.

The Vehicle Dynamics Control system provides its ABS control through the electrical circuit of the ABS system. Accordingly, if the ABS is inoperative, the Vehicle Dynamics Control system becomes unable to provide ABS control. As a result, the Vehicle Dynamics Control system also becomes inoperative, causing the warning light to illuminate. Though both the Vehicle Dynamics Control and ABS systems are inoperative in this case, the ordinary functions of the brake system are still available. You will be safe while driving with this condition, but have your vehicle checked at a SUBARU dealer as soon as possible.

NOTE

If the warning light behavior is as shown in the following, the Vehicle Dynamics Control system may be considered normal.

- The warning light illuminates right after the engine is started but turns off immediately, remaining off.
- The warning light illuminates after engine startup and turns off while the vehicle is subsequently being driven.

- The warning light illuminates during driving, but it turns off immediately and remains off.

▼ Traction Control system OFF indicator light

- It illuminates when the Traction Control system OFF switch is pressed.
- It also illuminates when the Traction Control system is deactivated.

NOTE

- The light may remain illuminated for a while after the engine has been started, especially in cold weather. This does not indicate the existence of a problem. The light should turn off as soon as the engine has warmed up.
- The indicator light illuminates when the engine has developed a problem and the CHECK ENGINE warning light/Malfunction indicator lamp illuminates.

The Vehicle Dynamics Control system is probably malfunctioning under the following condition. Have your vehicle checked at a SUBARU dealer as soon as possible.

- The light does not turn off even after the lapse of several minutes (the engine has warmed up) after the engine has started.

■ Security indicator light



The indicators are located in the center portion of the dashboard.

This indicator light shows the status of the alarm system. It also indicates operation of the immobilizer system.

▼ Alarm system

It blinks to show the driver the operational status of the alarm system. For detailed information, refer to the "Alarm system" section in chapter 2.

▼ Immobilizer system

This light blinks approximately 60 seconds after the ignition switch is turned from "ON" position to the "Acc" or "LOCK" position or immediately after the key is pulled out. Refer to the "Door locks"

– CONTINUED –

section in chapter 2.

If the indicator light does not flash, it may indicate that immobilizer system may be malfunctioning. Contact your nearest SUBARU dealer immediately.

In the event that an unauthorized key (for example, an unauthorized duplicate) is used, the security indicator light illuminates.

■ **SPORT mode indicator light**

This light illuminates when the ignition switch is turned to the “ON” position and turns off after the engine has started. When the selector lever is moved to the manual gate, the SPORT mode is selected and the indicator light illuminates. Refer to the “Automatic transmission” section in chapter 7.

■ **Selector lever/Gear position indicator**

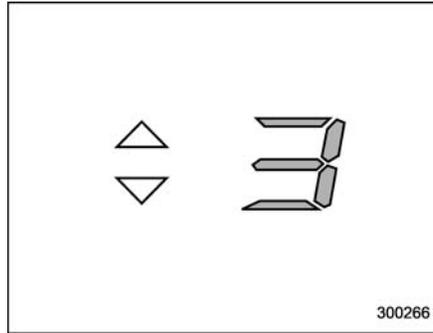

The selector lever/gear position indicator shows the position of the selector lever. When manual mode is selected, the gear position indicator shows the current gear position and the upshift/downshift indicator illuminates. Refer to the “Automatic transmission” section in chapter 7.

■ **Turn signal indicator lights** ← →

These lights show the operation of the turn signal or lane change signal. If the indicator lights do not blink or blink rapidly, the turn signal bulb may be burned out. Replace the bulb as soon as possible. Refer to the “Replacing bulbs” section in

chapter 11.

■ **High beam indicator light** 

This light shows that the headlights are in the high beam mode. This indicator light also illuminates when the headlight flasher is operated.

■ **Cruise control indicator light** CRUISE

The cruise control indicator light illuminates when the ignition switch is turned to the “ON” position and turns off after approximately 3 seconds. This light illuminates when the “CRUISE” main switch is pressed.

NOTE

- If you move the cruise control lever or press the main switch button while turning the ignition switch “ON”, the cruise control function is deactivated and the cruise control indicator light flashes. To reactivate the cruise control function, turn the ignition switch back to the “Acc” or “LOCK” position, and then turn it again to the “ON” position.
- If this indicator light and the CHECK ENGINE warning light/malfunction indicator lamp flash simultaneously dur-

ing driving, have the vehicle checked by your nearest SUBARU dealer.

■ **Cruise control set indicator light** SET

The cruise control set indicator light illuminates when the ignition switch is turned to the "ON" position and turns off after approximately 3 seconds.

This light illuminates when vehicle speed has been set.

■ **Headlight indicator light** ≡○○≡

This indicator light illuminates when the light switch is turned to the "≡○○≡" position (to turn on the parking lights) or to the "≡D" position (to turn on the headlights).

■ **Front fog light indicator light** ≡D

This indicator light illuminates while the front fog lights are illuminated.

Clock

NOTE

If your vehicle is equipped with a genuine SUBARU navigation system, refer to the Owner's Manual supplement for the navigation system.

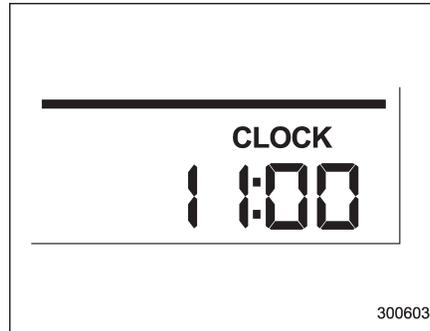

The clock shows the time while the ignition switch is in the "Acc" or "ON" position.

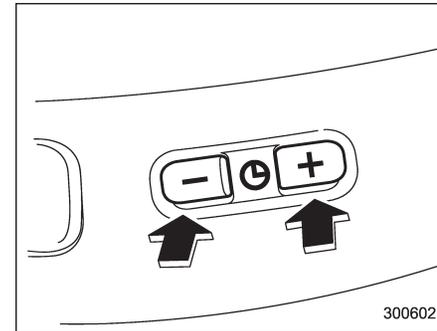

To adjust the time shown by the clock, press the "+" button or the "-" button. The indicated time will change in 1-minute increments. If you keep the button pressed, the rate at which the indicated time changes will speed up.

When you keep either the "+" or "-" button pressed, time change will pause for 1 second at the end of each 30-minute change. The clock will start going forward or backward again quickly after this 1-second pause.

CAUTION

To ensure safety, do not attempt to set the time during driving, as an accident could result.

Outside temperature indicator

NOTE

If your vehicle is equipped with a genuine SUBARU navigation system, refer to the Owner's Manual supplement for the navigation system.

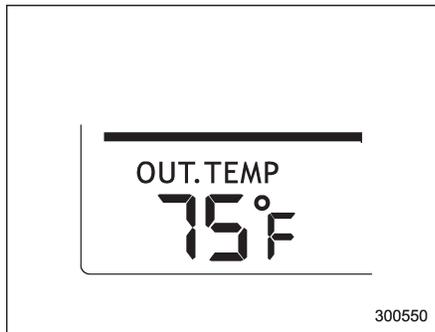

U.S.-spec. vehicles

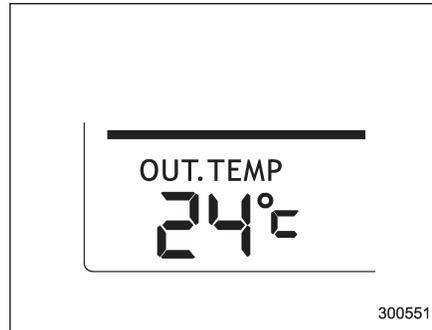

Except U.S.-spec. vehicles

The outside temperature indicator shows the outside temperature in a range from -22 to 122°F (-30 to 50°C) when the ignition switch is in the "ON" position.

The indicator can give a false reading under any of the following conditions:

- When there is too much sun.
- During idling; while running at low speeds in a traffic jam; when the engine is restarted immediately following a shut-down.
- When the actual outside temperature falls outside the specified indicator range.

Low outside temperature warning

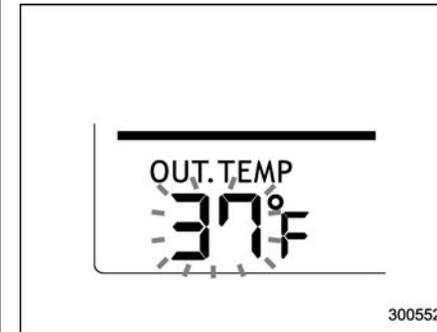

U.S.-spec. vehicles

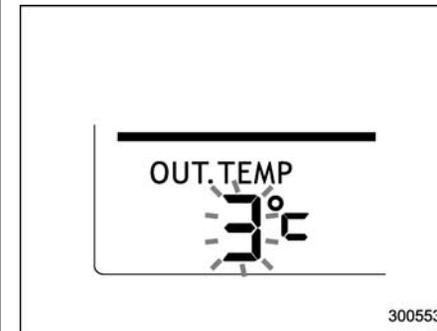

Except U.S.-spec. vehicles

When the outside temperature drops to

37°F (3°C) or lower, the temperature indication flashes to show that the road surface may be frozen.

If the outside temperature drops to 37°F (3°C) or lower while the display is giving an indication other than the outside temperature, the display switches to the outside temperature indication and flashes for 5 seconds before returning to its original indication.

If the display is already indicating an outside temperature of 37°F (3°C) or lower when the ignition switch is turned to the "ON" position, the indication does not flash.

NOTE

The outside temperature indication may differ from the actual outside temperature. The road surface freeze warning indication should be treated only as a guide. Be sure to check the condition of the road surface before driving.

Multi function display (vehicles without a genuine SUBARU navigation system)

NOTE

- If your vehicle is equipped with a genuine SUBARU navigation system, refer to the Owner's Manual supplement for the navigation system.
- A liquid-crystal display is used in the multi function display. You will find its indications hard to see if you wear polarized glasses.

With the ignition switch in the "ON" position, each successive push of the "INFO" button toggles the display in the following sequence:

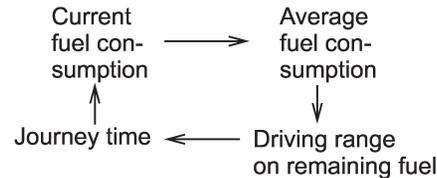

Press the "INFO" button for more than 1 second to turn off the display. The display will turn on again if you press either the "INFO" button or "AUDIO" button.

Current fuel consumption

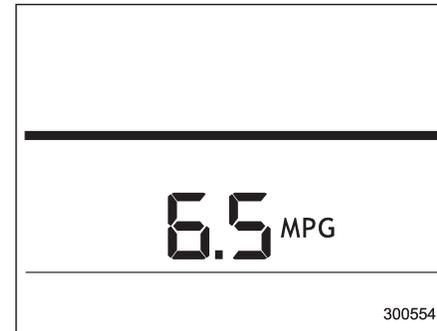

U.S.-spec. vehicles

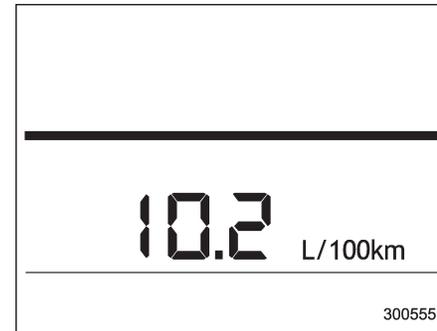

Except U.S.-spec. vehicles

This indication shows the rate of fuel consumption at the present moment.

■ Average fuel consumption

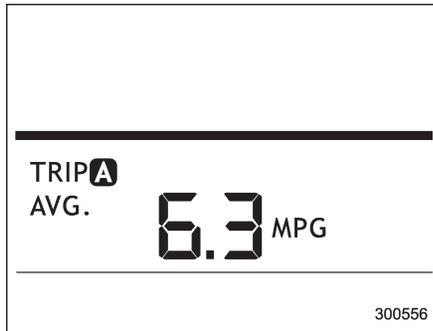

300556

U.S.-spec. vehicles

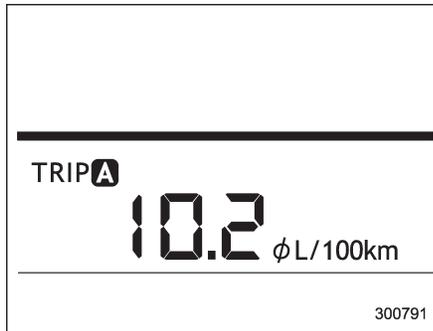

300791

Except U.S.-spec. vehicles

This indication shows the average rate of fuel consumption since the trip meter was

last reset.

Pressing the trip knob toggles the indication between the average fuel consumption corresponding to the A trip meter indication and the average fuel consumption corresponding to the B trip meter indication.

When either of the trip meter indications is reset, the corresponding average fuel consumption value is also reset.

NOTE

- The indicated values vary in accordance with changes in the vehicle's running conditions. Also, the indicated values may differ slightly from the actual values and should thus be treated only as a guide.

- When either trip meter indication is reset, the average fuel consumption corresponding to that trip meter indication is not shown until the vehicle has subsequently covered a distance of 1 mile (or 1 km).

■ Driving range on remaining fuel

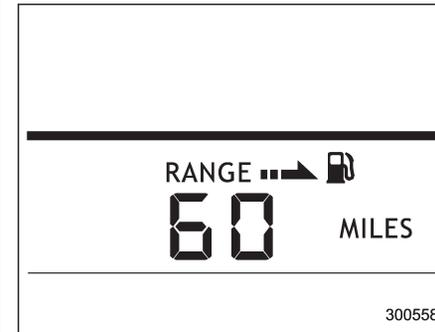

300558

U.S.-spec. vehicles

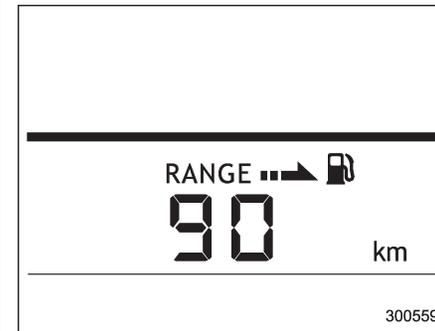

300559

Except U.S.-spec. vehicles

The driving range indicates the distance

that can be driven taking into account the amount of fuel remaining in the tank and the average rate of fuel consumption. When the low fuel warning light illuminates, the driving range indication flashes for 5 seconds. (The display first switches to the driving range indication if it was originally giving some other indication.)

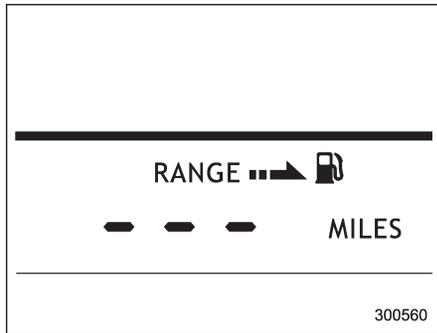

U.S.-spec. vehicles

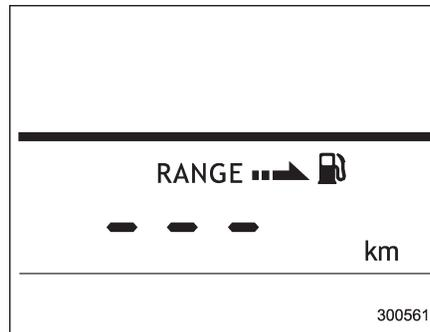

Except U.S.-spec. vehicles

If the driving range is shown as “---”, there is only a tiny amount of fuel left in the tank. You must refuel the vehicle immediately.

NOTE

- The driving range on remaining fuel is only a guide. The indicated value may differ from the actual driving range on remaining fuel, so you must immediately fill the tank when the low fuel warning light illuminates.
- When the low fuel warning light illuminates, the display automatically shows “---” even if the currently selected indication is not for the driving range on remaining fuel.

■ Journey time



The journey time shows the time that has elapsed since the ignition switch was turned to the “START” position.

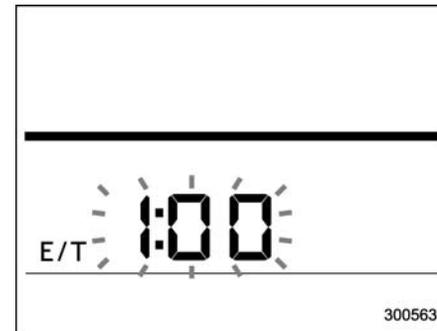

The journey time indication flashes each time a complete hour has elapsed. If the

– CONTINUED –

display is giving an indication other than the journey time, the display switches to the journey time, flashes for 5 seconds, and returns to its original indication each time a complete hour has elapsed.

NOTE

The journey time is reset when the ignition switch is turned to the “LOCK” position. It is also reset if the ignition switch is turned to the “LOCK” or “Acc” position prior to restarting of the engine.

Light control switch

WARNING

To prevent battery discharge resulting from accidentally leaving your lights on when your vehicle is parked, the light switch operates only when the ignition switch is in the “ON” position. In any other position, the vehicle’s lights will be out.

If you park your vehicle on a roadside at night, use the hazard warning flasher to alert the other drivers.

The light switch operates only when the ignition switch is in the “ON” position.

Headlights

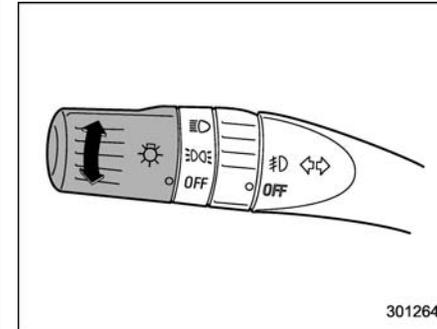

To turn on the headlights, turn the knob on the end of the turn signal lever.

☰ first position

Parking lights, instrument panel illumination, tail lights and license plate light are on.

☰ second position

Headlights, parking lights, instrument panel illumination, tail lights, and license plate light are on.

■ High/low beam change (dimmer)

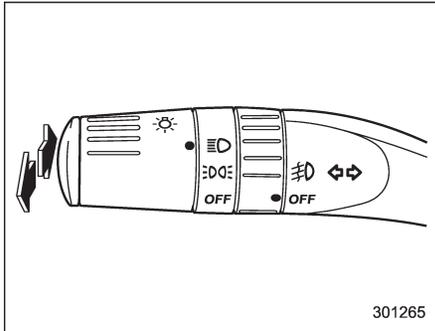

To change from low beam to high beam, push the turn signal lever forward. When the headlights are on high beam, the high beam indicator light “☀” on the combination meter also illuminates.

To switch back to low beam, pull the lever back to the detent position.

■ Headlight flasher

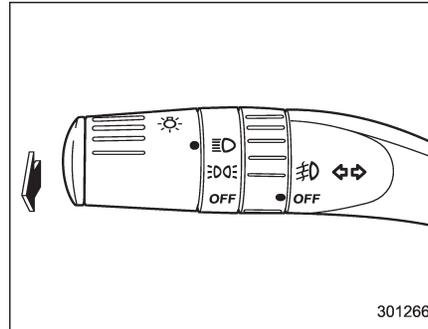

⚠ CAUTION

Do not hold the lever in the flashing position for more than just a few seconds.

To flash the headlights, pull the lever toward you and then release it. The high beam will stay on for as long as you hold the lever. The headlight flasher works even though the light switch is in the “OFF” position.

When the headlights are on high beam, the high beam indicator light “☀” on the combination meter also illuminates.

■ Daytime running light system

⚠ WARNING

The brightness of the illumination of the high beam headlights is reduced by the daytime running light system. The light switch must always be turned to the “☾” position when it is dark outside.

The high beam headlights will automatically illuminate at reduced brightness when the engine has started, under the following conditions:

- The parking brake is fully released.
- The light switch is in the “OFF” or “☾” position.

NOTE

When the light switch is in the “☾” position, the front side marker lights, parking lights and license plate lights are illuminated.

Turn signal lever

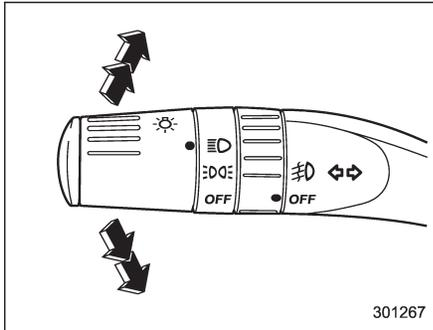

To activate the right turn signal, push the turn signal lever up. To activate the left turn signal, push the turn signal lever down. When the turn is finished, the lever will return automatically. If the lever does not return after cornering, return the lever to the neutral position by hand.

To signal a lane change, push the turn signal lever up or down slightly and hold it during the lane change. The turn signal indicator lights will flash in the direction of the turn or lane change. The lever will return automatically to the neutral position when you release it.

Illumination brightness control

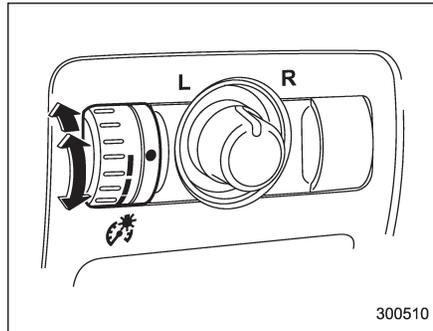

When the light switch is in the "OFF" position, you can adjust the brightness of the instrument panel illumination for better visibility.

The brightness of audio, air conditioner, multi-function display (if equipped) and instrument panel illumination automatically dims when the light switch is in the "☰" or "☷" position. You can adjust brightness of the illumination for better visibility.

To brighten, turn the control dial upward.
To darken, turn the control dial downward.

NOTE

When the control dial is turned fully upward, the illumination brightness becomes the maximum and the automatic dimming function does not work at all.

Headlight beam leveler (if equipped)

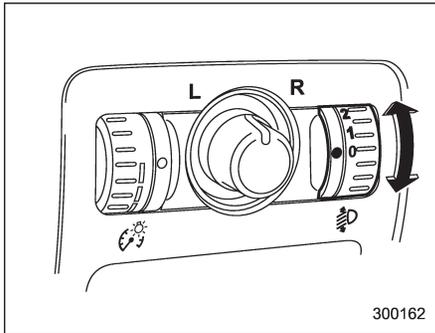

Adjust the headlight beam level with the following dial positions according to the number of passengers and load condition:

– CONTINUED –

3-30 *Instruments and controls***■ For 5-seater models**

Dial position	Number of front seat occupants	Number of rear seat occupants	Load in the luggage compartment area	Trailer towing
0	1 or 2	0	No load	No
1	2	3	No load	No
2	Not applicable	Not applicable	Not applicable	Not applicable
	Not applicable	Not applicable	Not applicable	Not applicable
3	2	3	Full load	No
4	2	3	Full load	Yes
	1	0	Full load	No
	1	0	Full load	Yes
5	Not applicable	Not applicable	Not applicable	Not applicable

■ For 7-seater models

Dial position	Number of front seat occupants	Number of 2nd seat occupants	Number of 3rd seat occupants	Load in the luggage compartment area	Trailer towing
0	1 or 2	0	0	No load	No
1	2	0	2	No load	No
2	2	3	2	No load	No
3	2	3	2	Full load	No
	2	3	2	Full load	Yes
4	Not applicable	Not applicable	Not applicable	Not applicable	Not applicable
5	1	0	0	Full load	No
	1	0	0	Full load	Yes

Parking light switch

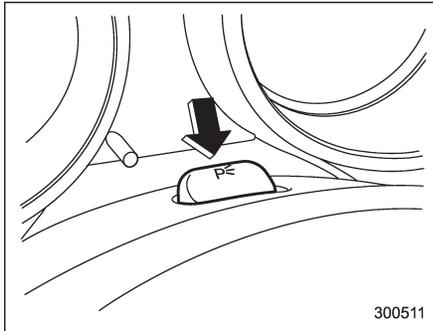

The parking light switch operates regardless of the ignition switch position.

By pushing the front end of this switch, following lights will illuminate.

- Parking lights
- Front and rear side marker lights
- Tail lights
- License plate lights

To turn off, push the rear end of the parking light switch.

Avoid leaving these lights on for a long time because that will run down the battery.

Front fog light switch

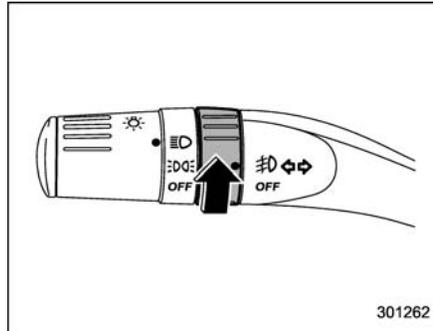

The front fog lights operate only when the light switch is in the "☐" position.

However, the front fog lights turn off when the headlights are switched to high beam.

To turn on the front fog lights, turn the fog light switch on the turn signal lever upward to the "☐" position.

To turn off the front fog lights, turn the switch back down to the "OFF" position.

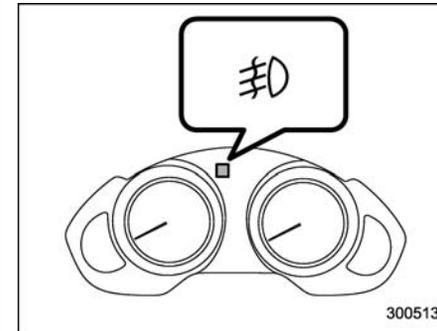

The indicator light on the combination meter will illuminate when the fog lights are illuminated.

Wiper and washer

WARNING

In freezing weather, do not use the windshield washer until the windshield is sufficiently warmed by the defroster.

Otherwise the washer fluid can freeze on the windshield, blocking your view.

CAUTION

- Do not operate the washer continuously for more than 10 seconds, or when the washer fluid tank is empty. This may cause overheating of the washer motor. Check the washer fluid level frequently, such as at fuel stops.
- Do not operate the wipers when the windshield or rear window is dry. This may scratch the glass, damage the wiper blades and cause the wiper motor to burn out. Before operating the wiper on a dry windshield or rear window, always use the windshield washer.

- In freezing weather, be sure that the wiper blades are not frozen to the windshield or rear window before switching on the wipers. Attempting to operate the wiper with the blades frozen to the window glass could cause not only the wiper blades to be damaged but also the wiper motor to burn out. If the wiper blades are frozen to the window glass, be sure to operate the defroster, wiper deicer (if equipped) or rear window defogger before turning on the wiper.
- If the wipers stop during operation because of ice or some other obstruction on the window, the wiper motor could burn out even if the wiper switch is turned off. If this occurs, promptly stop the vehicle in a safe place, turn the ignition switch to the "LOCK" position and clean the window glass to allow proper wiper operation.
- Use clean water if windshield washer fluid is unavailable. In areas where water freezes in winter, use SUBARU Windshield Washer Fluid or the equivalent. Refer to the "Windshield washer

fluid" section in chapter 11.

Also, when driving the vehicle when there are freezing temperatures, use non-freezing type wiper blades.

- Do not clean the wiper blades with gasoline or a solvent, such as paint thinner or benzine. This will cause deterioration of the wiper blades.

NOTE

- The front wiper motor is protected against overloads by a circuit breaker. The motor operates continuously under an unusually heavy load, the circuit breaker may trip to stop the motor temporarily. If this happens, park your vehicle in a safe place, turn off the wiper switch, and wait for approximately 10 minutes. The circuit breaker will reset itself, and the wipers will again operate normally.
- Clean your wiper blades and window glass periodically with a washer solution to prevent streaking, and to remove accumulations of road salt or road film. Keep the washer button depressed at least for 1 second so that washer solution will be sprinkled all over the windshield or rear window.

– CONTINUED –

- Grease, wax, insects or other material on the windshield or the wiper blades results in jerky wiper operation and streaking on the glass. If you cannot remove those streaks after operating the washer or if the wiper operation is jerky, clean the outer surface of the windshield or rear window and the wiper blades using a sponge or soft cloth with a neutral detergent or mild-abrasive cleaner. After cleaning, rinse the window glass and wiper blades with clean water. The glass is clean if no beads form on the glass when you rinse with water.
- If you cannot eliminate the streaking even after following this procedure, replace the wiper blades with new ones. Refer to the “Replacement of wiper blades” section in chapter 11 for replacement instructions.

■ Windshield wiper and washer switches

The wiper operates only when the ignition switch is in the “ON” or “Acc” position.

▼ Windshield wipers

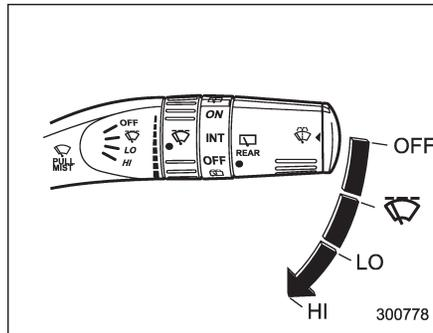

OFF: Park
: Intermittent
 LO: Low speed
 HI: High speed

To turn the wipers on, push the wiper control lever down.

To turn the wipers off, return the lever to the “OFF” position.

▼ Mist (for a single wipe)

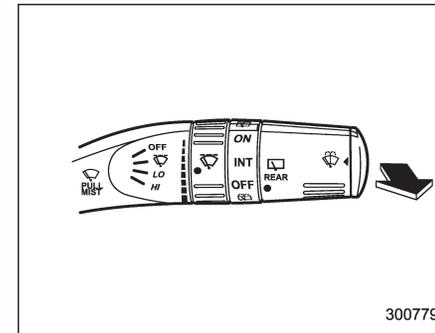

For a single wipe of the wipers, pull the lever toward you. The wipers operate until you release the lever.

▼ Wiper intermittent time control

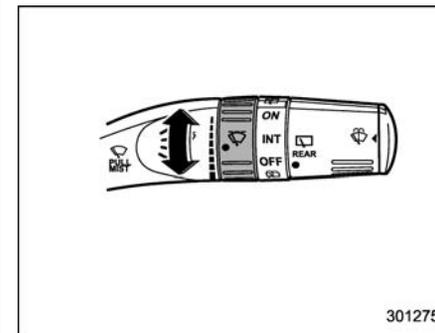

When the wiper switch is in the  position, turn the dial to adjust the operating interval of the wiper.

The operating interval can be adjusted in nine steps.

The intermittent operation interval varies depending on the vehicle speed in any of the adjustment steps (longer when the vehicle speed is low; shorter when the vehicle speed is high).

▼ Washer

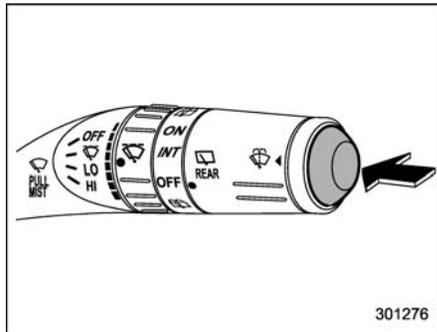

To wash the windshield, push the washer button at the end of the wiper control lever. The washer fluid sprays until you release the washer button. The wipers operate while you push the button.

NOTE

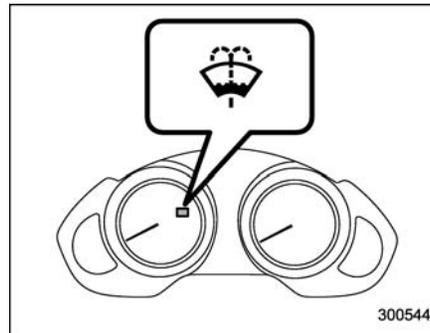

The windshield washer fluid warning light illuminates when the washer fluid level in the tank has dropped to the lower limit. If the warning light illuminates, refill the tank with fluid. For the tank refilling method, refer to the “Windshield washer fluid” section in chapter 11.

■ Rear window wiper and washer switch

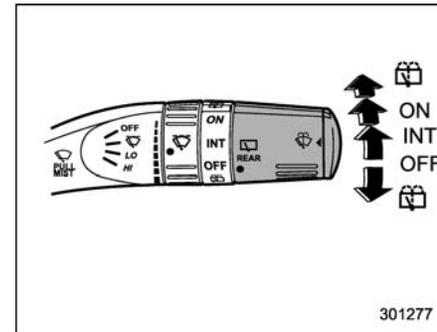

 Washer (accompanied by wiper operation)

ON: Continuous

INT: Intermittent

OFF: Park

 Washer

▼ Rear wiper

To turn the rear wiper on, turn the knob on the end of the wiper control lever upward to the “INT” or “ON” position.

To turn the wiper off, return the knob on the end of the lever to the “OFF” position.

With the switch turned to the “INT” position, the rear wiper will operate intermittently at intervals corresponding to the

– CONTINUED –

vehicle speed (longer when the vehicle speed is low; shorter when the vehicle speed is high).

When you subsequently move the selector lever of the automatic transmission to the "R" position, the rear wiper will switch to continuous operation. When you move the selector lever from the "R" position to some other position, the rear wiper will return to intermittent operation.

▼ **Washer**

To wash the rear window while the rear wiper is operating, turn the knob on the end of the wiper control lever upward to the "W" position. The washer fluid sprays until you release the knob.

To wash the rear window when the rear wiper is not in use, turn the knob on the end of the wiper control lever downward to the "W" position. The washer fluid sprays and the wiper operates until you release the knob.

Windshield wiper deicer

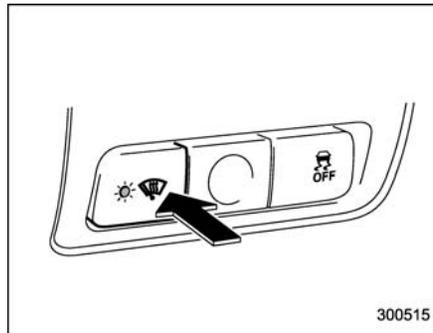

The windshield wiper deicer operates only when the ignition switch is in the "ON" position.

Before turning on the windshield wiper deicer, remove any snow from the windshield. To turn on the windshield wiper deicer, push the button. The indicator light located on the button lights up while the windshield wiper deicer is operating.

The windshield wiper deicer will automatically shut off after approximately 15 minutes. If the windshield wiper blades have been deiced completely before that time, push the button to turn it off. It also turns off when the ignition switch is turned to the "Acc" or "LOCK" position. If deicing

is not complete, you have to push the button to turn the deicer on again.

Your SUBARU dealer can set your windshield wiper deicer for continuous operation. Contact your SUBARU dealer for details.

Once the windshield wiper deicer has been set for continuous operation, pressing the button results in continuous operation. The windshield wiper deicer automatically stops operating if any one of the following conditions occurs during continuous operation.

- The outside temperature becomes 41°F (5°C) or higher.
- The vehicle speed remains at 9 mph (15 km/h) or lower for 15 minutes.
- The battery voltage decreases below the permissible level.

Rear window defogger button

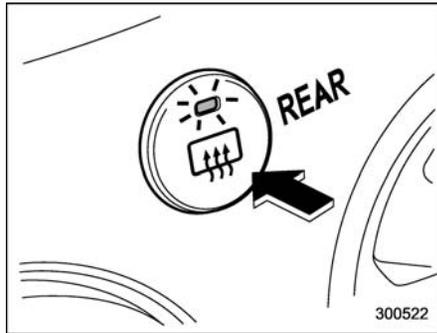

The rear window defogger operates only when the ignition switch is in the "ON" position.

The rear window defogger button is located on the climate control panel.

To turn on the defogger, push the button.

To turn it off, push the button again.

The indicator light located on the button lights up while the rear window defogger is operating.

The defogger will automatically shut off after approximately 15 minutes. If the window clears before that time, push the button to turn it off. It also turns off when

the ignition switch is turned to the "Acc" or "LOCK" position. If defrosting or defogging is desired when you restart your vehicle, you have to push the button to turn it on again.

Your SUBARU dealer can set your rear window defogger for continuous operation. Contact your SUBARU dealer for details.

Once the rear window defogger has been set for continuous operation, the rear window defogger repeatedly operates for 15 minutes, stops for 2 minutes, and again operates for 15 minutes. If the battery voltage drops below the permissible level, continuous operation is canceled and operation stops as described in the following.

- If the battery voltage drops below the permissible level within 15 minutes of depression of the button, continuous operation is canceled and the rear window defogger stops operating 15 minutes later.
- If the battery voltage drops below the permissible level after the rear window defogger has, following depression of the button, operated for 15 minutes, stopped operating for 2 minutes, and started operating again, the rear window defogger immediately stops operating.

CAUTION

- Do not use sharp instruments or window cleaner containing abrasives to clean the inner surface of the rear window. They may damage the conductors printed on the window.
- To prevent the battery from being discharged, do not operate the defogger continuously for any longer than necessary.

NOTE

If your vehicle is equipped with the outside mirror defogger, the outside mirror defogger operates while the rear window defogger is operating.

Mirrors

Always check that the inside and outside mirrors are properly adjusted before you start driving.

■ Inside mirror

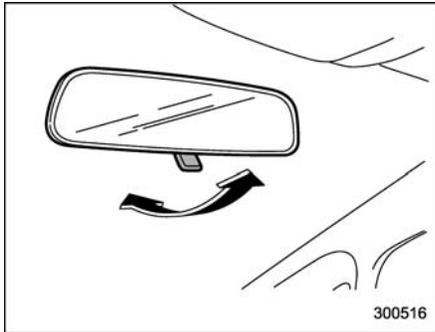

The inside mirror has a day and night position. Pull the tab at the bottom of the mirror toward you for the night position. Push it away for the day position. The night position reduces glare from headlights.

■ Auto-dimming mirror/compass (if equipped)

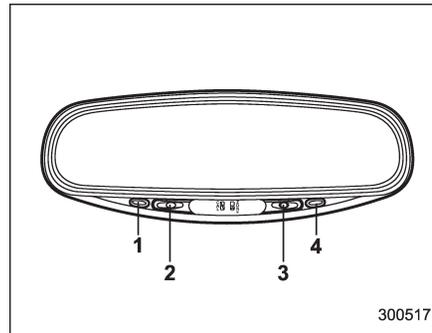

- 1) Left button
- 2) Auto dimming indicator
- 3) Photosensor
- 4) Right button

The auto-dimming mirror/compass has an anti-glare feature which automatically reduces glare coming from headlights of vehicles behind you. It also contains a built-in compass.

- By pressing and releasing the left button, the automatic dimming function is toggled on or off. When the automatic dimming function is on, the auto dimming indicator light (green) located to the right of the button will illuminate.
- By pressing and releasing the right

button, the compass display is toggled on or off. When the compass is on, an illuminated compass reading will appear in the lower part of the mirror.

Even with the mirror in anti-glare mode, the mirror surface turns bright if the transmission is shifted into reverse. This is to ensure good rearward visibility during reversing.

▼ Photosensors

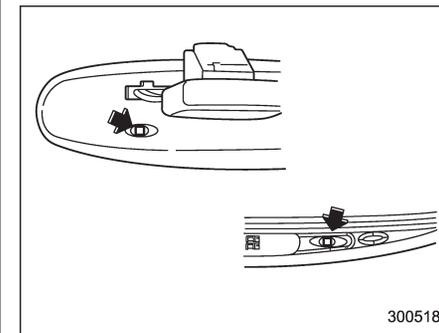

The mirror has a photosensor attached on both the front and back sides. If the glare from the headlights of vehicles behind you strikes the mirror, these sensors detect it and make the reflection surface of the mirror dimmer to help prevent you from being blinded. For this reason, use care not to cover the sensors with stickers, or

other similar items. Periodically wipe the sensors clean using a piece of dry soft cotton cloth or an applicator.

▼ Compass calibration

1. For optimum calibration, switch off all nonessential electrical accessories (rear window defogger, heater/air conditioning system, spotlight, etc.) and ensure all doors are shut.
2. Drive to an open, level area away from large metallic objects or structures and make certain the ignition switch is in the "ON" position.
3. Press and hold the left button for 3 seconds then release, and the compass will enter the calibration mode. "CAL" and direction will be displayed.
4. Drive slowly in a circle until "CAL" disappears from the display (approximately two or three circles). The compass is now calibrated.
5. Further calibration may be necessary should outside influences cause the mirror to read inaccurately. You will know that this has occurred if your compass begins to read in only limited directions. Should you encounter this situation, return to step one of the above procedure and recalibrate the mirror.

▼ Compass zone adjustment

1. The zone setting is factory preset to Zone 8. Refer to the "Compass calibration zone" map attached to the end of this manual to verify that the compass zone setting is correct for your geographical location.
2. Press and hold the right button for 3 seconds then release, and the word "ZONE" will briefly appear and then the zone number will be displayed.
3. Press the right-hand button repeatedly to cycle the display through all possible zone settings. Stop cycling when the correct zone setting for your location is displayed.
4. Releasing the button for 3 seconds will exit the zone setting mode.

■ Outside mirrors

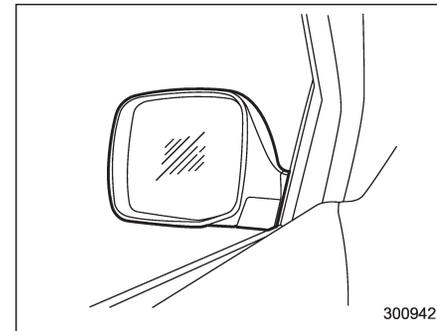

▼ Convex mirror (passenger side)

⚠ WARNING

Objects look smaller in a convex mirror and farther away than when viewed in a flat mirror. Do not use the convex mirror to judge the distance of vehicles behind you when changing lanes. Use the inside mirror (or glance backwards) to determine the actual size and distance of objects that you view in convex mirror.

– CONTINUED –

▼ Remote control mirror switch

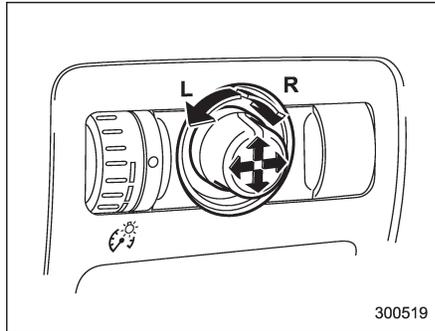

The remote control mirrors operate only when the ignition switch is in the “ON” or “Acc” position.

1. Turn the knob to the “L” side to adjust the left-hand mirror or to the “R” side to adjust the right-hand mirror.
2. Move the knob in the direction you want to move the mirror.
3. Return the knob to the neutral position to prevent unintentional operation.

The mirrors can also be adjusted manually.

▼ Outside mirror defogger

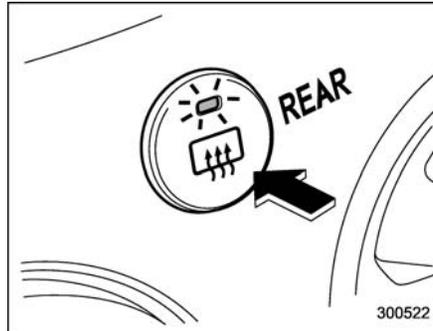

The outside mirror defogger shares the button with rear window defogger.

The outside mirror defogger operates only when the ignition switch is in the “ON” position.

To turn on the outside mirror defogger, push the button.

To turn it off, push the button again. The indicator light located on the button lights up while the outside mirror defogger is operating.

The defogger will automatically shut off after approximately 15 minutes. If the mirror clears before that time, push the button to turn it off. It also turns off when the ignition switch is turned to the “Acc” or

“LOCK” position. If defrosting or defogging is desired when you restart your vehicle, you have to push the button to turn it on again.

NOTE

- While the outside mirror defogger is operating, the rear window defogger also operates.
- When the rear window defogger has been set for continuous operation, the outside mirror defogger also operates continuously. Refer to the “Rear window defogger button” section in this chapter.

 CAUTION
To prevent the battery from being discharged, do not operate the defogger continuously for any longer than necessary.

▼ Power folding mirror switch (Latin American models, if equipped)

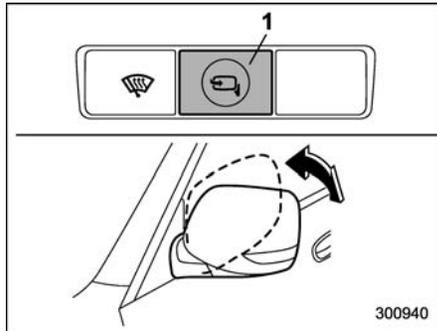

1) Power folding mirror switch

The power folding mirror switch operates only when the ignition switch is in the "ON" or "Acc" position.

To fold the outside mirrors, push the power folding mirror switch. To unfold the mirrors, push the switch again.

NOTE

● When the temperature is low, the outside mirrors may stop during operation. Push the switch again. When the outside mirrors do not work by switch operation, move them several times manually. This makes it possible to operate them by switch operation.

- When you operate the power folding mirror switch continuously, it may temporarily stop working. This is not a malfunction. Operate it again after waiting for a short period of time.
- When you unfold the outside mirrors manually, the mirrors may become unstable. Be sure to unfold the mirrors by switch operation. If the outside mirrors are still unstable, fold the mirrors again manually and then unfold them by switch operation.

Tilt steering wheel

⚠ WARNING

Do not adjust the steering wheel tilt position while driving. This may cause loss of vehicle control and result in personal injury.

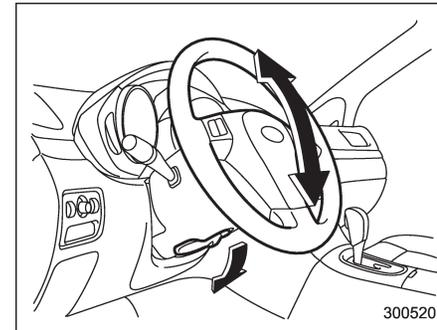

1. Adjust the seat position. Refer to the "Front seats" section in chapter 1.
2. Pull the tilt lock lever down.
3. Move the steering wheel to the desired level.
4. Pull the lever up to lock the steering wheel in place.

– CONTINUED –

3-42 *Instruments and controls*

5. Make sure that the steering wheel is securely locked by moving it up and down.

Horn

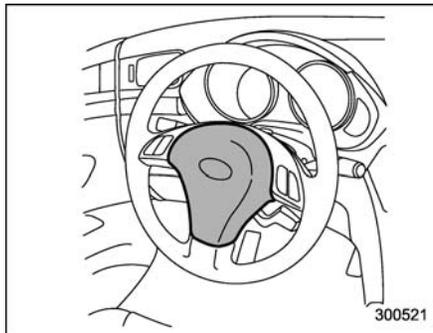

To sound the horn, push the horn pad.

Climate control

Ventilator.....	4-2	Lubrication oil circulation in the refrigerant circuit.....	4-10
Air flow.....	4-2	Checking air conditioning system before summer season.....	4-10
Ventilator.....	4-4	Cooling and dehumidifying in high humidity and low temperature weather conditions.....	4-10
Automatic climate control system.....	4-5	Air conditioner compressor shut-off when engine is heavily loaded.....	4-10
Control panel.....	4-5	Refrigerant for your climate control system.....	4-10
Rear air conditioner (if equipped).....	4-8	Air filtration system.....	4-11
Temperature sensors.....	4-9	Replacing the air filter.....	4-11
Operating tips for heater and air conditioner.....	4-10		
Cleaning ventilator grille.....	4-10		
Efficient cooling after parking in direct sunlight.....	4-10		

Ventilator

■ Air flow

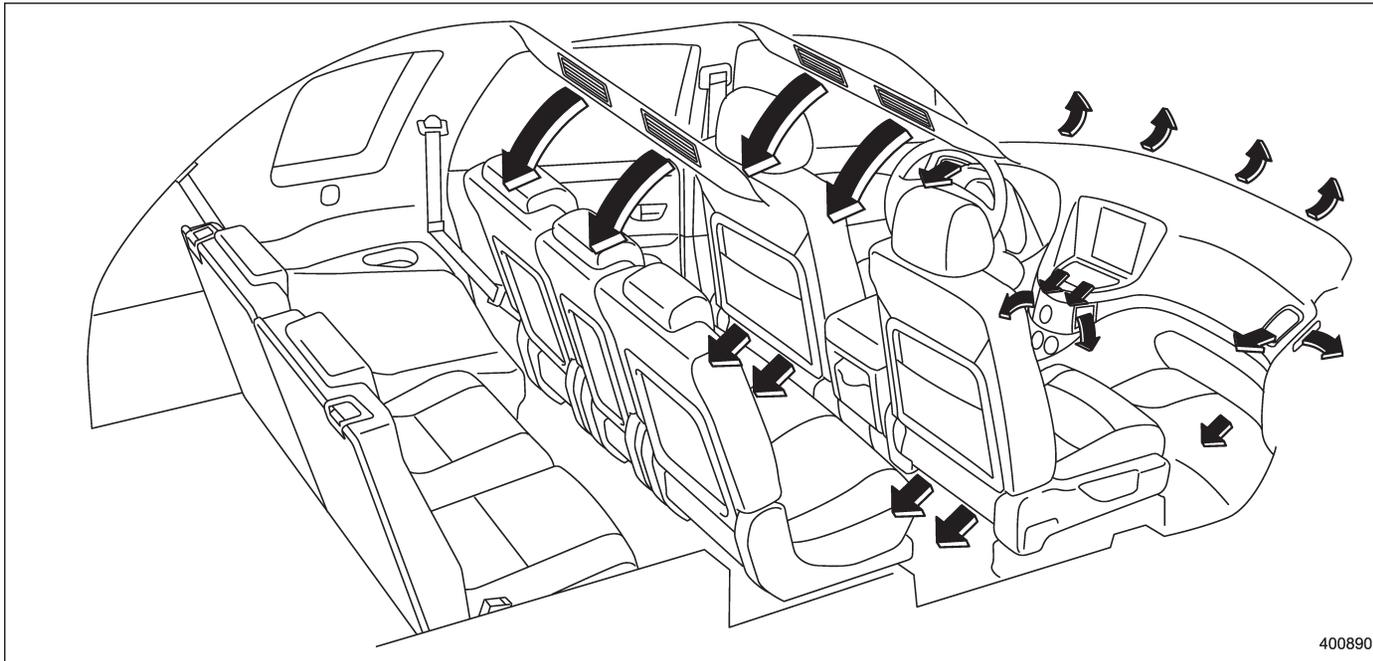

▼ Air flow mode selection

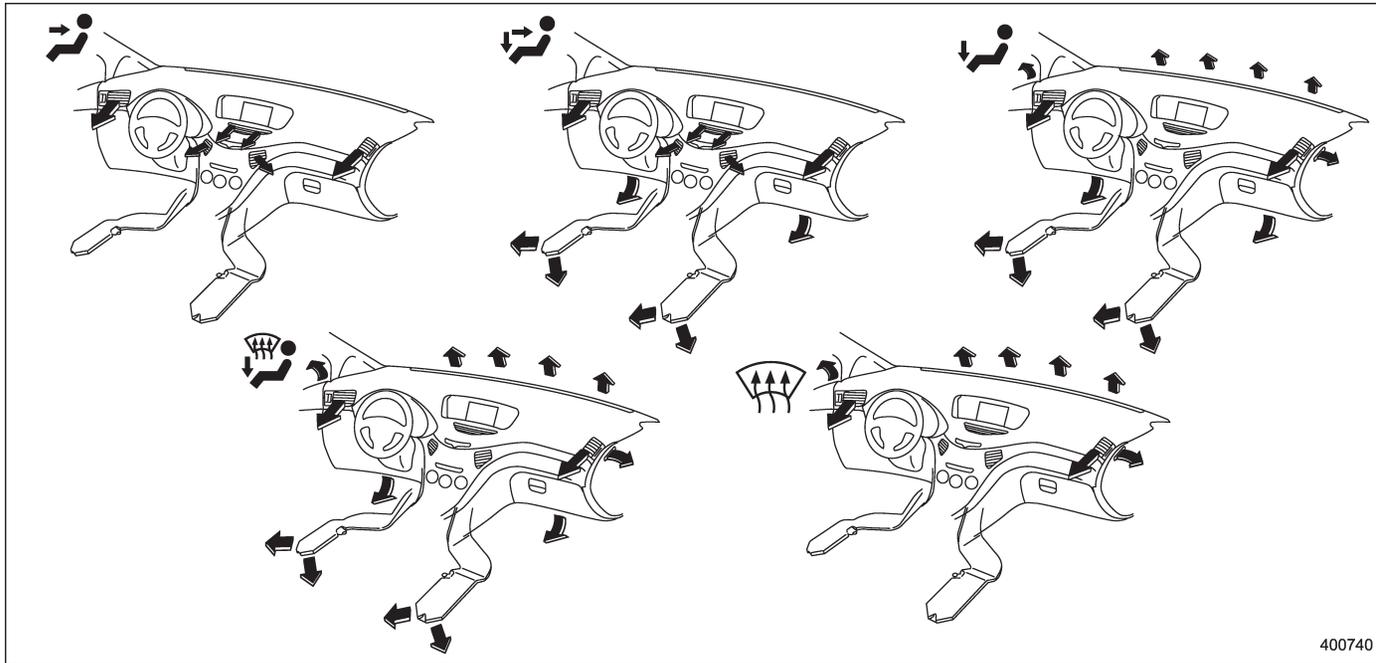

– CONTINUED –

4-4 Climate control

■ Ventilator

▼ Center ventilators

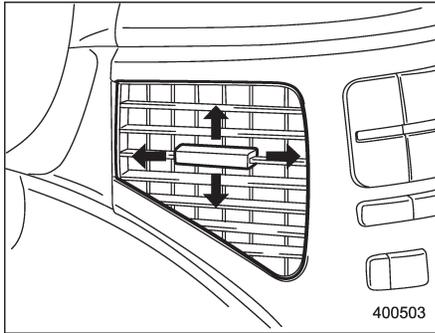

Move the tab up and down or right and left to adjust the flow direction.

▼ Side ventilators

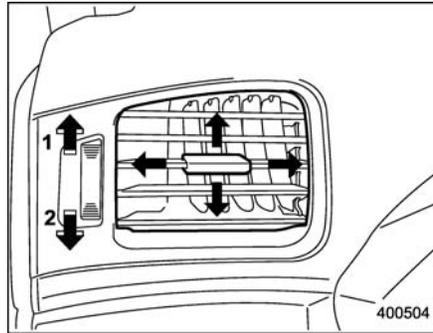

- 1) Open
- 2) Close

Move the tab up and down or right and left to adjust the flow direction.

To open the ventilator, turn the side grille open/close wheel upward.

To close it, turn the wheel downward.

▼ Rear ventilators (if equipped)

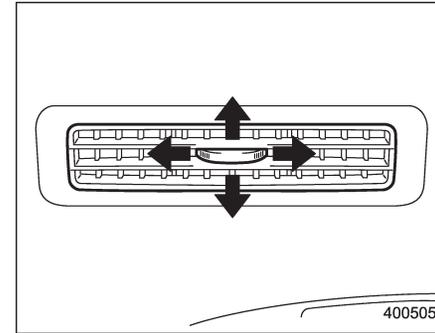

Move the tab up and down or rotate right and left to adjust the flow direction.

Automatic climate control system

NOTE

- Operate the automatic climate control system when the engine is running.
- The blower fan rotates at a low speed when the engine coolant temperature is low.

For efficient defogging or dehumidifying in cold weather, press the "A/C" button.

- Even when cooling is not necessary, setting the temperature much lower than the current outlet air temperature turns on the air conditioner compressor automatically and the indicator light on the "A/C" button illuminates.
- 7-seater models each have a rear air conditioner. The fan speed of the rear air conditioner can be adjusted, but other adjustments (outlet air temperature, air distribution, etc.) are not possible for the rear air conditioner. For details, refer to "Rear air conditioner" in this section.

The automatic climate control system automatically controls outlet air temperature, fan speed, air flow distribution air-inlet control, and air conditioner compressor operation. It activates when the

"AUTO" button is pressed, and is used to maintain a constant, comfortable climate within the passenger compartment.

The temperature can be set within a range of 65 to 85°F (18 to 32°C).

■ Control panel

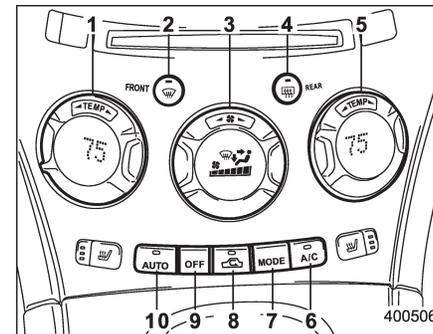

- 1) Temperature control dial (driver's side)
- 2) Defroster button
- 3) Fan speed control dial
- 4) Rear window defogger button (Refer to "Rear window defogger button" in chapter 3.)
- 5) Temperature control dial (passenger's side)
- 6) Air conditioner button
- 7) Air flow mode selection button
- 8) Air inlet selection button
- 9) OFF button
- 10) AUTO button

▼ AUTO button

AUTO mode operation:

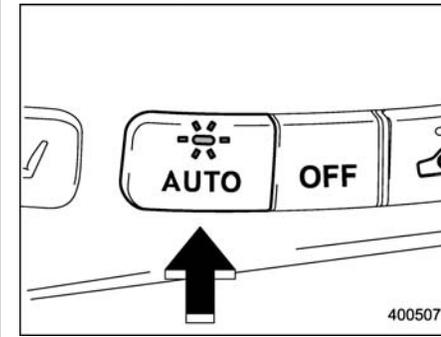

When the "AUTO" button is pressed, the indicator light on the button illuminates. In this state, fan speed, air flow distribution, air-inlet control, and air conditioner compressor operation are automatically controlled.

Manual mode operation:

If you operate any of the buttons on the control panel other than the "OFF" button and temperature control dial during automatic mode operation, the indicator light will turn off. You can then manually control the system as desired using the button you operated.

To change the system back to the AUTO mode, press the "AUTO" button.

– CONTINUED –

4-6 Climate control

▼ OFF button

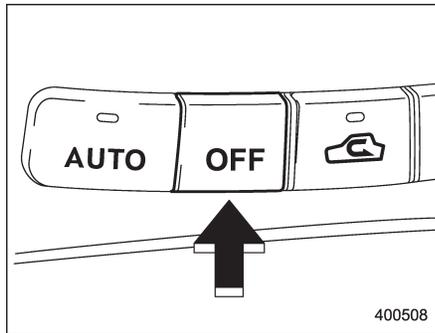

The Automatic Climate Control system turns off (the air conditioner compressor and fan turn off) when the "OFF" button is pressed.

When the "OFF" button is pressed, the outside air introduction mode (air inlet selection OFF) is automatically selected.

▼ Temperature control dial

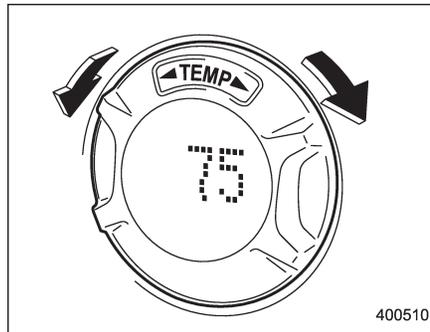

Driver's side

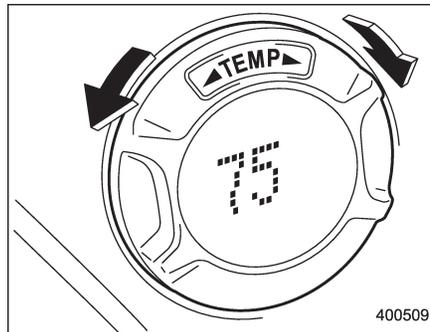

Passenger's side

It is possible to make separate temperature settings for the driver's side and

passenger's side. Each temperature setting is shown on the display. With the dial set at your desired temperature, the system automatically adjusts the temperature of air supplied from the outlets such that the desired temperature is achieved and maintained.

Turning the dial counterclockwise and releasing it reduces the temperature by 1°F (0.5°C). Turning the dial clockwise and releasing it increases the temperature by 1°F (0.5°C). Holding the dial in either turned position causes the temperature to change continuously.

With the minimum temperature set, the system gives maximum cooling performance. With the maximum temperature set, the system gives maximum heating performance.

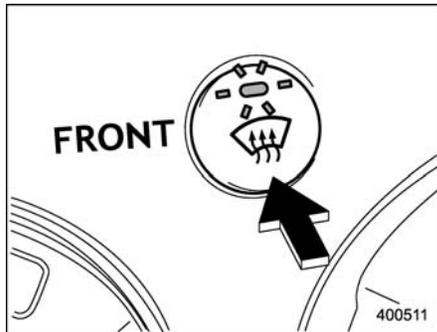
▼  – Defroster button

To defrost or dehumidify the windshield and front door windows, push the defroster button "". When the "" button is pushed, outside air is drawn into the passenger compartment, air flow is directed towards the windshield and front door windows, and the indicator light on the button illuminates.

After eliminating the fogging from the windshield, return the climate control system to the AUTO mode by pushing the "AUTO" button or turn off by pushing the "OFF" button.

Alternatively, push the "" button again to return the system to the setting that was selected before you activated the defroster.

▼ Fan speed control dial

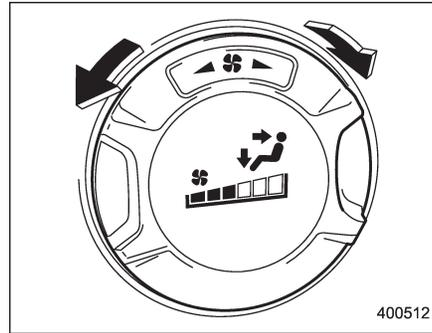

The fan speed control dial has 7 positions: AUTO position and 6 different fan speed positions.

The fan speed is shown on the center of the dial.

With the fan speed control dial in the AUTO position, the fan speed changes automatically corresponding the various conditions: air temperature inside and outside of the passenger's compartment, intensity of the sunlight, etc.

▼ A/C – Air conditioner button

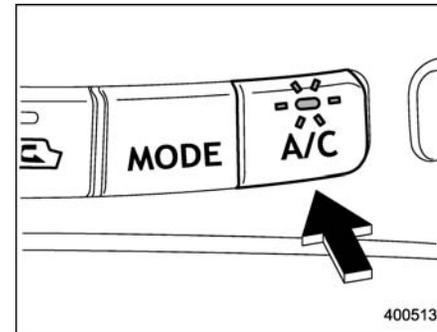

If the windshield starts to fog when the climate control system is operated in the AUTO mode, push the air conditioner button to defog and dehumidify.

When this button is pushed, the air conditioner compressor turns on and the indicator light on the button illuminates. After eliminating the fogging from the windshield, set the system back to the AUTO mode by pushing the "AUTO" button.

NOTE

The air conditioner compressor does not operate when the outside air temperature is below 32°F (0°C).

– CONTINUED –

4-8 Climate control

▼ Air flow mode selection button

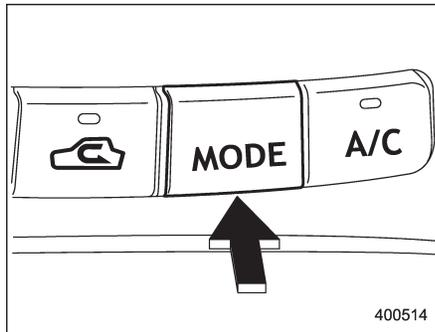

Select the desired air flow mode by pushing the air flow mode selection button. The selected air flow mode is shown on the center of the dial.

 (Ventilation): Air flows through the instrument panel outlets.

 (Bi-level): Air flows through the instrument panel outlets and the foot outlets.

 (Heat): Air flows through the instrument panel outlets, the foot outlets, and some through the windshield defroster outlets.

 (Heat-def): Air flows through the instrument panel outlets, the windshield defroster outlets, and the foot outlets.

▼ Air inlet selection button

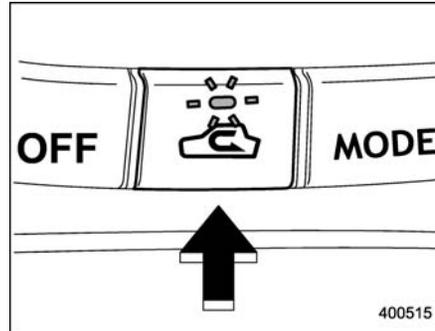

ON position (recirculation): Interior air is recirculated inside the vehicle. Push the air inlet selection button to the ON position for fast cooling with the air conditioner or when driving on a dusty road. The indicator light will illuminate.

OFF position (outside air): Outside air is drawn into the passenger compartment. Push the air inlet selection button to the OFF position when the interior has cooled to a comfortable temperature and the road is no longer dusty. The indicator light will turn off.

WARNING

Continued operation in the ON position may fog up the windows. Switch to the OFF position as soon as the

outside dusty condition clears.

NOTE

When driving on a dusty road or behind a vehicle that emits unpleasant exhaust gases, set the air inlet selection button to the ON position.

From time to time, return the air inlet selection button to the OFF position to draw outside air into the passenger compartment.

■ Rear air conditioner (if equipped)

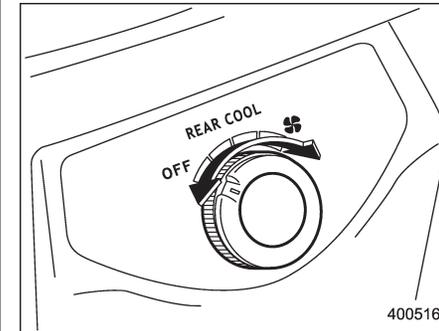

The rear air conditioner blows cool air out of the rear ventilators while the "A/C" button on the control panel is in the "ON" position.

position. The fan speed of the rear air conditioner can be adjusted using the rear air conditioner dial behind the center console. The fan speed can be adjusted in four steps by turning the dial. Turn the dial to the "OFF" position to stop the fan.

NOTE

- When the "A/C" button is in the "OFF" position and when the "A/C" indicator is not illuminated during AUTO mode operation, the air conditioner compressor does not operate, meaning that the system merely blows uncooled air out of the ventilators.
- The outlet air temperature of the rear air conditioner cannot be adjusted.
- The rear air conditioner cannot be used as a heater.

■ Temperature sensors

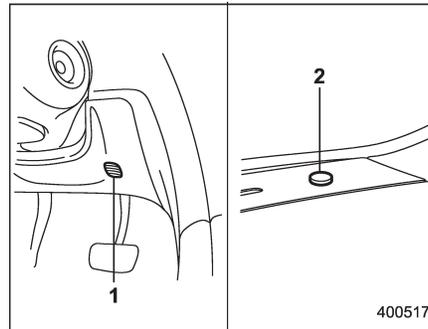

- 1) Interior air temperature sensor
- 2) Solar sensor

The automatic climate control system employs several sensors. These sensors are delicate. If they are treated incorrectly and become damaged, the system may not be able to control the interior temperature correctly. To avoid damaging the sensors, observe the following precautions:

- Do not subject the sensors to impact.
- Keep water away from the sensors.
- Do not cover the sensors.

The sensors are located as follows:

- Solar sensor: beside windshield defroster grille

- Interior air temperature sensor: on the side of the driver-side part of the center panel
- Outside temperature sensor: behind front grille

Operating tips for heater and air conditioner

■ Cleaning ventilator grille

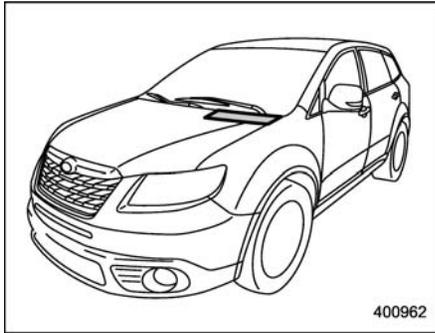

Always keep the front ventilator inlet grille free of snow, leaves, or other obstructions to ensure efficient heating and defrosting. Since the condenser is located in front of the radiator, this area should be kept clean because cooling performance is impaired by any accumulation of insects and leaves on the condenser.

■ Efficient cooling after parking in direct sunlight

After parking in direct sunlight, drive with the windows open for a few minutes to allow outside air to circulate into the

heated interior. This results in quicker cooling by the air conditioner. Keep the windows closed during the operation of the air conditioner for maximum cooling efficiency.

■ Lubrication oil circulation in the refrigerant circuit

Operate the air conditioner compressor at a low engine speed (at idle or low driving speeds) a few minutes each month during the off-season to circulate its oil.

■ Checking air conditioning system before summer season

Check the air conditioner unit for refrigerant leaks, hose conditions, and proper operation each spring. Have your SUBARU dealer perform this check.

■ Cooling and dehumidifying in high humidity and low temperature weather conditions

Under certain weather conditions (high relative humidity, low temperatures, etc.) a small amount of water vapor emission from the air outlets may be noticed. This condition is normal and does not indicate any problem with the air conditioning system.

■ Air conditioner compressor shut-off when engine is heavily loaded

To improve acceleration and gas mileage, the air conditioner compressor is designed to temporarily shut off during air conditioner operation whenever the accelerator is fully depressed such as during rapid acceleration or when driving on a steep upgrade.

■ Refrigerant for your climate control system

Your air conditioner uses ozone friendly refrigerant HFC134a. Therefore, the method of adding, changing or checking the refrigerant is different from the method for CFC12 (freon). Consult your SUBARU dealer for service. Repairs needed as a result of using the wrong refrigerant are not covered under warranty.

Air filtration system

Replace the filter element according to the replacement schedule shown in the following. This schedule should be followed to maintain the filter's dust collection ability. Under extremely dusty conditions, the filter should be replaced more frequently. It is recommended that you have your filter checked or replaced by your SUBARU dealer. For replacement, we recommend the use of a genuine SUBARU air filter kit.

Replacement schedule:

Every 15 months or 15,000 miles (24,000 km) whichever comes first

■ Replacing the air filter

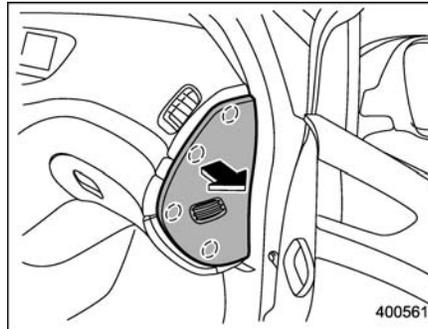

1. Remove the instrument panel side cover.

NOTE

The instrument panel side cover is held in place with four pins.

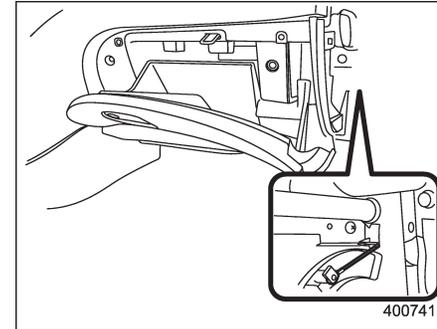

2. Unhook the strap.

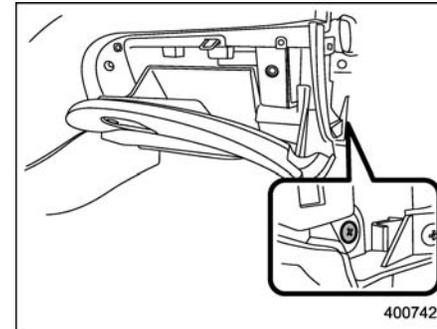

3. Remove the glove box by detaching the one clip on the side.

– CONTINUED –

4-12 Climate control

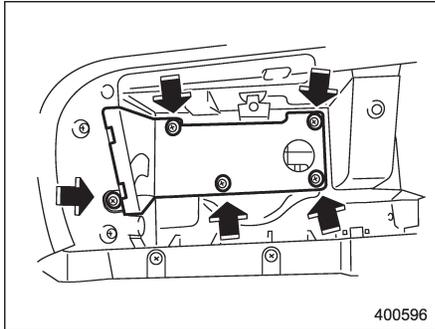

4. Remove the air filter cover by detaching the five clips.

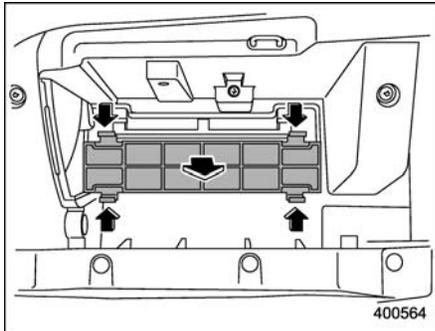

5. Unhook the air filter and draw it out.

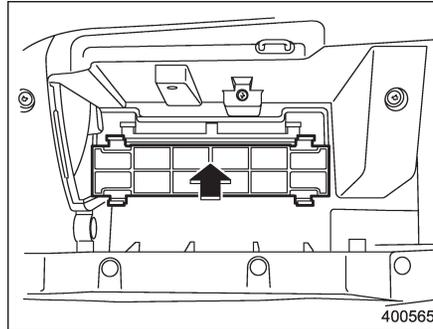

6. Replace the air filter with a new one.
7. Install the air filter cover.
8. Install the glove box.

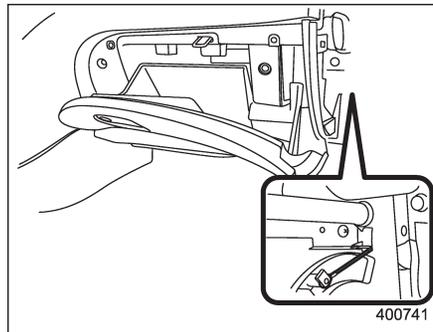

9. Attach the strap to the hook.

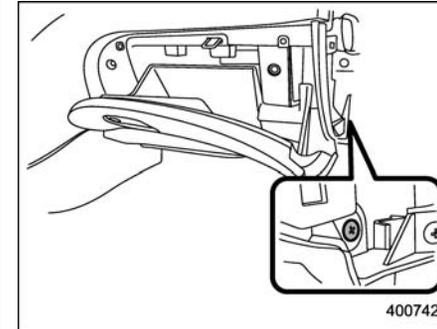

10. Secure the glove box with the one clip.
11. Install the instrument panel side cover.

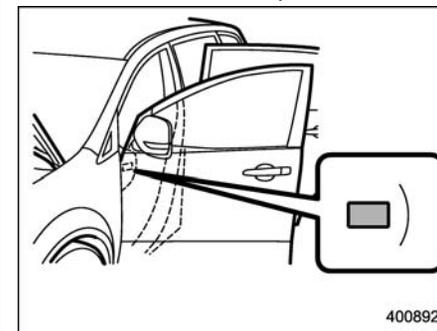

12. Label installation
Attach the caution label to the driver's door.



CAUTION

Contact your SUBARU dealer if the following occurs, even if it is not yet time to change the filter:

- Reduction of the air flow through the vents.
- Windshield gets easily fogged or misted.

NOTE

The filter can influence the air conditioning, heating and defroster performance if not properly maintained.

Audio

Antenna system	5-2	Type B audio set (if equipped).....	5-16
Printed antenna.....	5-2	Radio operation	5-16
FM reception	5-2	Built in CD changer operation	5-22
XM™ satellite radio reception (if equipped).....	5-2	Audio control buttons	5-27
Installation of accessories.....	5-4	MODE button.....	5-27
Audio set	5-4	Aux unit operation.....	5-29
Type A audio set.....	5-4	Rear Seat Entertainment (RSE) system	
Type B audio set.....	5-4	operation (if equipped)	5-29
Type A audio set (if equipped)	5-5	Precautions to observe when handling a	
Radio operation.....	5-5	compact disc.....	5-30
Compact disc player operation	5-11		

Antenna system

■ Printed antenna



Do not use sharp instruments or window cleaner containing abrasives to clean the inner surface of the window on which the antenna is printed. Doing so may damage the antenna printed on the window.

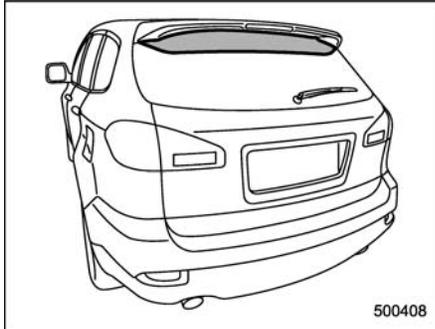

The antenna is printed on the inner surface of the rear window glass.

NOTE

Antenna performance will deteriorate significantly if you apply tinting film or

any other material over the antenna portion of the rear window glass.

■ FM reception

Although FM is normally static free, reception can be affected by the surrounding area, atmospheric conditions, station strength and transmitter distance. Buildings or other obstructions may cause momentary static, flutter or station interference. If reception continues to be unsatisfactory, switch to a stronger station.

NOTE

If a cell phone is placed near the radio, it may cause the radio to emit noise when it receives calls. This noise does not indicate a radio malfunction.

XM™ satellite radio reception (if equipped)

XM™ is a continental U.S. based satellite radio service including music, news, sports, talk and children's programming. XM™ provides digital quality audio and text information, including song title and artist name. A service fee is required to receive the XM™ service. For more information, contact XM™ at www.xmradio.com or call 1-800-XMRADIO (1-800-967-2346) for U.S. www.xmradio.ca or call 1-877-GET-XMSR (1-877-438-9677) for Canada.

The XM™ satellite radio receiver that is fitted to your vehicle receives the necessary signals from two specially designated satellites that are in a geostationary orbit over the equator. One satellite covers the east coast and the other covers the west coast. Both of them direct their signals north. These signals are then relayed throughout the USA by a network of ground repeater stations. The satellite radio signals are transmitted as "line of sight" signals. Line of sight signals can be blocked by objects such as buildings, but the network of repeater stations allows signal coverage within urban areas such as cities.

You may experience problems in receiving XM™ satellite radio signals in the following situations.

- If you are driving northward in a coastal area

You will notice that the XM™ satellite radio antenna is fixed to the upper right hand corner of your windscreen.

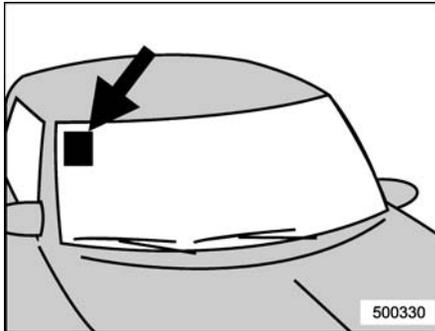

The signal comes from the south and may not be able to reach the antenna in some circumstances when you are driving north.

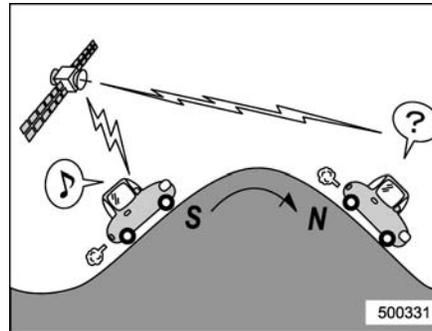

- If you are driving in a tunnel or a covered parking area
- If you are driving beneath the top level of a multi-level freeway
- If you drive under a bridge
- If you are driving next to a tall vehicle (such as a truck or a bus) that blocks the signal
- If you are driving in a valley where the surrounding hills or peaks block the signal from the south
- If you are driving on a mountain road where the southern direction is blocked by mountains



- If you are driving in an area with tall trees that block the signal (10 m or more), for example on a road that goes through a dense forest
- The signal can become weak in some areas that are not covered by the repeater station network.

Please note that these may be other unforeseen circumstances when there are problems with the reception of XM™ satellite radio signals.

5-4 Audio

Installation of accessories

Always consult your SUBARU dealer before installing a citizen band radio or other transmitting device in your vehicle. Such devices may cause the electronic control system to malfunction if they are incorrectly installed or if they are not suited for the vehicle.

Audio set

Your SUBARU may be equipped with one of the following audio sets. See the pages indicated in this section for operating details.

■ Type A audio set

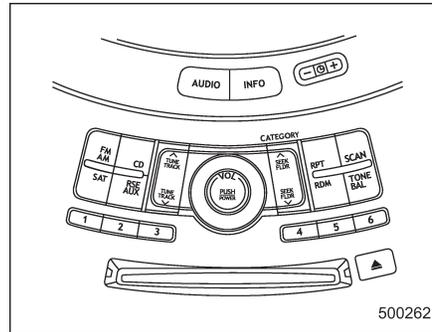

- Radio operation: refer to page 5-5
- CD (compact disc) player operation: refer to page 5-11

■ Type B audio set

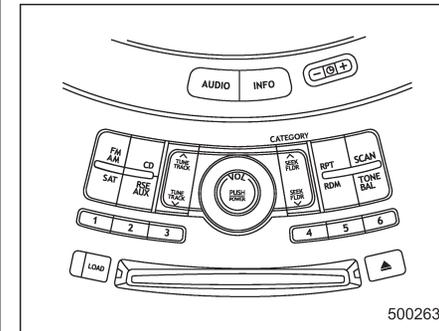

- Radio operation: refer to page 5-16
- Built-in CD changer operation: refer to page 5-22

Type A audio set (if equipped)

The audio set will operate only when the ignition switch is in the "Acc" or "ON" position.

■ Radio operation

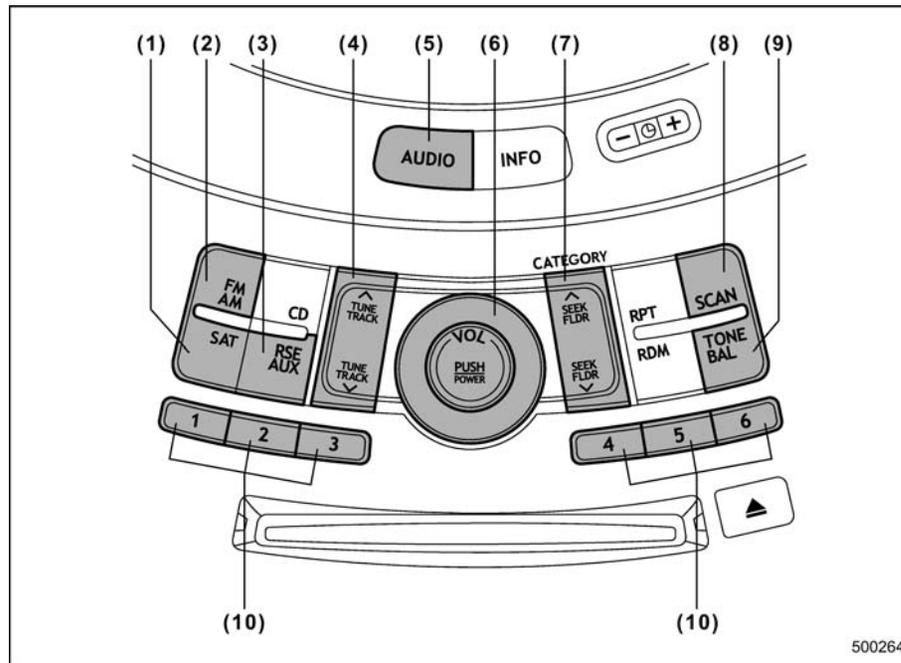

- (1) Satellite radio mode button
- (2) FM AM mode button
- (3) Auxiliary unit and Rear seat entertainment button
- (4) Tuning button
- (5) AUDIO button
- (6) Power switch, volume control dial
- (7) Seek button
- (8) Scan button
- (9) Tone and Balance button
- (10) Preset button

▼ Power switch and volume control

The dial (6) is used for both power (ON/OFF) and volume control. The radio is turned ON and OFF by pushing the dial and the volume is controlled by turning the dial. The dial can also be used for tone and balance adjustment.

▼ Tone and balance control

The volume control dial (6) normally functions as a volume control. This dial becomes a control for Bass, Midrange, Treble, Fader or Balance when you select the appropriate tone and balance control mode.

Choose desired volume level for each mode by turning the volume control dial. The control function returns to volume control mode after approximately 5 seconds.

– CONTINUED –

5-6 Audio

▽ To change tone and balance control modes

Each brief press of the "TONE BAL" button (9) changes control modes in the following sequence starting from volume control mode. (When the radio is first turned on, the control mode is in the volume control.)

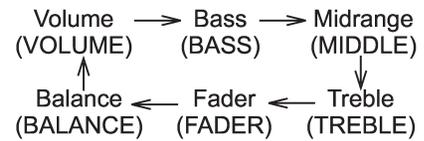

The "TONE BAL" button is used for selecting the following control modes:

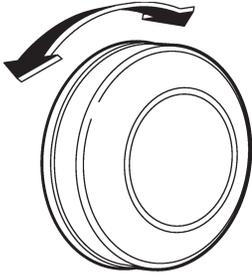
Control mode (range of levels)		
	Turn counterclockwise	Turn clockwise
Bass control (-6 to +6)	For less bass sound	For more bass sound
Midrange control (-6 to +6)	For less midrange sound	For more midrange sound
Treble control (-6 to +6)	For less treble sound	For more treble sound
Fader control (R9 to F9)	To increase rear speaker volume and decrease front speaker volume	To increase front speaker volume and decrease rear speaker volume
Balance control (L9 to R9)	To increase left speaker volume and decrease right speaker volume	To increase right speaker volume and decrease left speaker volume
Volume control (0 to 40)	For less volume	For more volume
AUX volume control* (0 to 40)	For less volume	For more volume

500204

* Only when an AUX audio product is connected.

▼ **FM/AM radio**

▽ **FM/AM selection button**

Push the “FM AM” button (2) when the radio is off to turn on the radio.

Push the “FM AM” button when the radio is on to select FM1, FM2 or AM reception.

▽ **Stereo indicator**

The stereo indicator “ST” will illuminate when an FM stereo broadcast is received.

▽ **Manual tuning**

Press the “^” side of the “TUNE TRACK” button (4) to increase the tuning frequency and press the “v” side of the button to decrease it.

Each time the button is pressed, the frequency interval can be changed between 10 kHz in the AM mode and 0.2 MHz in the FM mode.

If you hold down the “^” side of the button, the tuning frequency will increase continuously, and if you hold down the “v” side of the button, the tuning frequency will decrease continuously. Release the button when your desired frequency is reached.

– CONTINUED –

NOTE

While you are holding down either side of the “TUNE TRACK” button, the tuning frequency will not stop changing even if the frequency of a receivable station is reached.

▽ Seek tuning

If you press the “^” or “v” side of the “SEEK FLDR” button (7), the radio will automatically search for a receivable station and stop at the first one it finds. This function may not be available, however, when radio signals are weak. In such a situation, perform manual tuning to select the desired station.

▽ Automatic tuning (SCAN)

Press the “SCAN” button (8) to change the radio to the SCAN mode. In this mode, the radio scans through the radio band until a station is found. The radio will stop at the station for 5 seconds while displaying the frequency, after which scanning will continue until the entire band has been scanned from the low end to the high end. Press the “SCAN” button again to cancel the SCAN mode and to stop on any displayed frequency.

Press the “^” or “v” side of the “SEEK FLDR” button (7) again to cancel the scan mode and to stop on any displayed

frequency.

When the “SCAN” button is pressed for automatic tuning, stations are scanned in the direction of low frequencies to high frequencies only.

Automatic tuning may not function properly if the station reception is weakened by distance from the station or proximity to tall buildings and hills.

▽ Selecting preset stations

Presetting a station with a preset button (10) allows you to select that station in a single operation. Up to six, AM, FM1 and FM2 stations each may be preset.

▽ How to preset stations

1. Press the “FM AM” button (2) to select FM1, FM2, or AM reception.
2. Press the “SCAN” button (8) or tune the radio manually until the desired station frequency is displayed.
3. Press one of the preset buttons (10) for more than 1.5 seconds to store the frequency. If the button is pressed for less than 1.5 seconds, the preceding selection will remain in memory.

NOTE

- If the connection between the radio and battery is broken for any reason such as vehicle maintenance or radio

removal, all stations stored in the preset buttons are cleared. If this occurs, it is necessary to reset the preset buttons.

- If a cell phone is placed near the radio, it may cause the radio to emit noise when it receives calls. This noise does not indicate a radio malfunction.

▼ Satellite radio mode (if equipped)

To receive satellite radio, it is necessary to install the SUBARU genuine satellite receiver (optional part) and to enter into a contract. For details, please contact your SUBARU dealer.

▽ Sirius satellite radio

Sirius satellite radio is a recent innovation that allows the listener to experience digital sound quality and to have a greater variety of channels.

Use of satellite radio (Sirius) requires a tuner, antenna and a service contract. For details, please contact your SUBARU dealer or visit Sirius Satellite Radio at www.sirius.com or call 1-888-539-SIRIUS (7474) for more information. Sirius, the Sirius dog logo, channel names and logos are trademarks of SIRIUS Satellite Radio Inc.

▽ XM™ satellite radio

XM™ is a continental U.S. based satellite radio service including music, news, sports, talk and children's programming. XM™ provides digital quality audio and text information, including song title and artist name. A service fee is required to receive the XM™ service. For more information, contact your SUBARU dealer or XM™ at www.xmradio.com or call 1-800-XMRADIO (1-800-967-2346) for U.S. www.xmradio.ca or call 1-877-GET-XMSR (1-877-438-9677) for Canada.

▽ Satellite radio reception

Satellite radio signals are best received in areas with a clear view of the open sky. In areas where there are tall buildings, trees, tunnels or other structures that may obstruct the signal of the satellites, there may be signal interruptions. Other circumstances that may result in signal loss include driving near a wall, steep cliff or hill, or driving on the lower level of a multi-tiered road or inside a parking garage.

To help reduce this condition, satellite radio providers have installed ground-based repeaters in heavily populated areas. However, you may still experience reception problems in some areas.

▽ Displaying satellite radio ID of tuner

When you activate satellite radio, you should have your satellite radio tuner ID ready because each tuner is identified by its unique satellite radio tuner ID.

The satellite radio ID will be needed when you activate satellite radio and receive satellite radio customer support.

The satellite radio ID can be found on the audio display by tuning the channel to "0". Turn the "TUNE TRACK" button (4) to select the satellite radio channel.

▽ Band selection button

Push the "SAT" button (1) when the radio is off to turn on the radio.

Push the "SAT" button when the radio is on to select SAT1, SAT2 or SAT3 reception.

▽ Channel selection

Press "∧" of the "TUNE TRACK" button (4) to select the next channel and press "∨" of the button to select the previous channel.

Keep pressing "∧" of the button to change to the next channel continuously and keep pressing "∨" of the button to change to the previous channel continuously.

▽ Category selection

Press "∧" or "∨" of the "SEEK FLDR" button (7) to display the current category. Press "∧" again to select the next category, and press "∨" again to select the previous category.

▽ Channel scan

Press the "SCAN" button (8) to change the radio to the SCAN mode. In this mode, the radio scans through the channels until a station is found. The radio will stop at the station for 5 seconds while displaying the channel number, after which scanning will continue until the entire channel has been scanned from the low end to the high end. Also during the category selection, channel scan can be performed in that category.

Press the "SCAN" button again to cancel the SCAN mode and to stop on any displayed channel.

▽ Selecting preset channels

Presetting a channel with a preset button (10) allows you to select that channel in a single operation. Up to six, SAT1, SAT2 and SAT3 channels each may be preset.

▽ How to preset channels

1. Press the "SAT" button (1) to select SAT1, SAT2 and SAT3 reception.

– CONTINUED –

5-10 Audio

2. Press the "SCAN" button (8) or the "TUNE TRACK" button (4) to select the channel.
3. Press one of the preset buttons (10) for more than 1.5 seconds to store the channel. If the button is pressed for less than 1.5 seconds, the preceding selection will remain in memory.

NOTE

If the connection between the radio and battery is broken for any reason such as vehicle maintenance or radio removal, all channels stored in the preset buttons are cleared. If this occurs, it is necessary to reset the preset buttons.

▽ Display selection

Press the "AUDIO" button (5) while receiving satellite radio to change the display as follows:



▼ Rear seat entertainment

If your vehicle is equipped with a Rear Seat Entertainment System, you can enjoy audio outputs from the system through the vehicle's speakers by pressing the "RSE AUX" button (3). Press the

button again to return to the audio set sound.

NOTE

If your vehicle is equipped with a Rear Seat Entertainment System, refer to the Owner's Manual supplement for the Rear Seat Entertainment System for further details.

■ Compact disc player operation

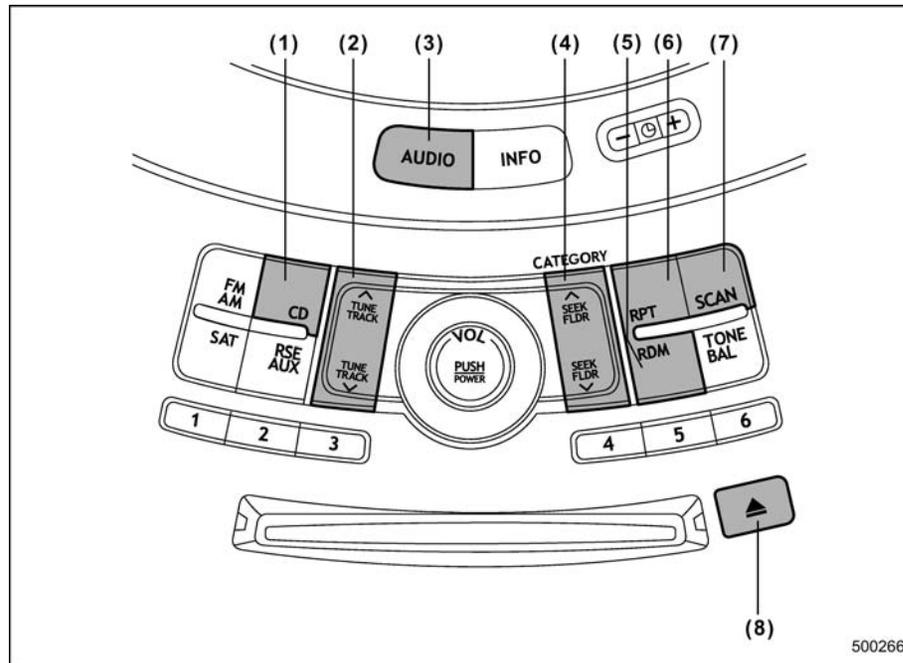

- (1) CD button
- (2) Track button
- (3) AUDIO button
- (4) Seek and Folder button
- (5) Random button
- (6) Repeat button
- (7) Scan button
- (8) Eject button

▼ To playback a compact disc

▽ When CD is not in the player

Hold a disc with a finger in the center hole while gripping the edge of the disc, then insert it in to the slot (with the label side up) and the player will automatically pull the disc into position.

NOTE

- DO NOT INSERT TWO DISCS INTO THE DISC INSERTION SLOT AT A TIME.
- Be sure to insert a disc with the label side up. If you insert the disc the label side down, "CHECK DISC" will appear on the display and the player will not play anything.
- After the last song finishes, the player will automatically return to track 1 (the first song on the disc).

– CONTINUED –

- If you insert a disc that cannot be played by the player, “CHECK DISC” will appear on the display and the player will revert to the previously selected mode.
- The player is designed to be able to play music CD-Rs and music CD-RWs, but it may not be able to play certain ones.
- CDs (i.e., 8 cm/3 inch CDs) are not supported, and if inserted, they will be immediately ejected.

▽ When CD is in the player

When the “CD” button (1) is pressed, the player will start playback.

NOTE

After the last song finishes, the player will automatically return to track 1 (the first song on the disc).

▼ To stop playback of a CD

When the “PUSH POWER” button is pressed during playback of a CD, the CD stops playing temporarily. To let the CD resume playing, press the button again.

▼ To select a song from its beginning

▽ Forward direction

Briefly press the “^” side of the “TUNE TRACK” button (2) to skip to the beginning

of the next track/file (track). Each time this side of the button is pressed, the indicated track/file (track) number will increase.

NOTE

In an MP3 folder, skipping past the last track/file (track) will take you back to the first track/file (track) in the folder.

▽ Backward direction

Briefly press the “v” side of the “TUNE TRACK” button (2) to skip to the beginning of the current track/file (track). Each time this side of the button is pressed, the indicated track/file (track) number will decrease.

NOTE

In an MP3 folder, skipping past the last track/file (track) will take you back to the first track/file (track) in the folder.

▼ Fast-forwarding and fast-reversing

▽ Fast-forwarding

Press the “^” side of the “TUNE TRACK” button (2) continuously to fast-forward the track/file.

Release the button to stop fast-forwarding.

NOTE

If you fast-forward past the last track/file (track) on the disc, the player will

select the first track/file (track) on the disc and start playing it.

▽ Fast-reversing

Press the “v” side of the “TUNE TRACK” button (2) continuously to fast-reverse the track/file (track).

Release the button to stop fast-reversing.

NOTE

If you fast-reverse to the beginning of the first track/file (track) on the disc, the fast-reversing will stop and the player will start playing the first track/file (track) on the disc.

▼ Folder selection (MP3 disc)

Press the “^” side of the “SEEK FLDR” button (4) briefly to select the next folder. Pressing the “v” side of the same button the first time makes the player go back to the beginning of the currently selected file; pressing it a second time makes it go back to the previously selected file.

NOTE

Only MP3 folders are recognized when an attempt to select the next or previous folder is made. If no appropriate folder exists on the disc, pressing the “^” or “v” side of the “SEEK FLDR” button has no effect.

▼ Repeating

▽ To repeat the currently playing track/file (track)

To repeat a track/file (track), briefly press the “RPT” button (6) while the track/file (track) is playing. The display will show “RPT”, and the track/file (track) will be repeated.

To cancel the track/file (track) repeat-play mode:

Press the “RPT” button once (non-MP3 disc)

Press the “RPT” button twice (MP3 disc)
The “RPT” indication will turn off, and the normal playback mode will be resumed.

NOTE

- With an MP3 disc inserted, each time you briefly press the button, the mode will change to the next one in the following sequence.



If you accidentally press the button and cancel the track/file (track) repeat-play mode, press it again to reselect the repeat-play mode.

- The repeat-play mode will be canceled if you perform any of the following steps:

- Press the “RDM” button
- Press the “SCAN” button
- Press the “▲” button
- Select the radio mode
- Press the “RSE AUX” button
- Press the “√” or “^” side of the “SEEK FLDR” button (MP3 disc)
- Turn off the power of the audio equipment.
- Turn the ignition switch to the “LOCK” position.

▽ To repeat the currently playing folder (MP3 disc)

To repeat the currently playing folder, press the “RPT” button (6) twice while a file (track) is playing. The display will show “F-RPT”, and the folder will be played repeatedly.

To cancel the folder repeat-play mode, press the “RPT” button once more. The “F-RPT” indication will turn off, and the normal playback mode will be resumed.

NOTE

- Each time you briefly press the button, the mode will change to the next one in the following sequence.



If you accidentally press the button and

cancel the folder repeat-play mode, press it again to reselect the folder repeat-play mode.

- The folder repeat-play mode will be cancelled if you perform any of the following steps:

- Press the “RDM” button
- Press the “SCAN” button
- Press the “▲” button
- Select the radio mode
- Press the “RSE AUX” button
- Press the “√” or “^” side of the “SEEK FLDR” button (MP3 disc)
- Turn off the power of the audio equipment.
- Turn the ignition switch to the “LOCK” position.

▼ Random playback

▽ Non-MP3 disc

Press the “RDM” button (5) briefly during disc playback to play all of the tracks on the disc in a random order. The display will show “RDM”, and all of the tracks on the disc will be played in a random order.

To cancel random mode, press the button again. The “RDM” indication will turn off, and the normal playback mode will be resumed.

NOTE

Random playback will be cancelled if you perform any of the following steps:

- Press the “RPT” button
- Press the “SCAN” button
- Press the “▲” button
- Select the radio mode
- Press the “RSE AUX” button
- Press the “√” or “^” side of the “SEEK FLDR” button
- Turn off the power of the audio equipment.
- Turn the ignition switch to the “LOCK” position.

▼ MP3 disc

Press the “RDM” button (5) during disc playback to play all of the tracks in the folder currently being played in random order. Press the “RDM” button again to play all of the tracks on the disc in random order. The display will show “RDM” during the random mode.

To cancel the random mode, press the “RDM” button during “in-disc” random playback. The “RDM” indication will turn off, and the normal playback mode will be resumed.

NOTE

- Each time you briefly press the button, the mode will change to the

next one in the following sequence.

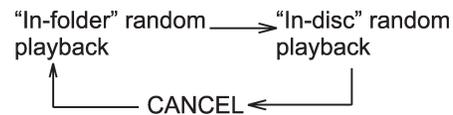

If you accidentally press the button and cancel the random mode, press it again to reselect the random mode.

• Random playback will be cancelled if you perform any of the following steps:

- Press the “RPT” button
- Press the “SCAN” button
- Press the “▲” button
- Select the radio mode
- Press the “RSE AUX” button
- Press the “√” or “^” side of the “SEEK FLDR” button
- Turn off the power of the audio equipment.
- Turn the ignition switch to the “LOCK” position.

▼ Scan

The scan mode lets you listen to the first 10 seconds of each track/file (track) on the disc/folder in succession. Press the “SCAN” button (7) to start scanning through all tracks upward beginning with the track/file (track) following the currently

selected one. After all tracks/files (tracks) on the disc/folder has been scanned, normal playback mode is restored.

To cancel a scan, press the button again.

NOTE

The scan mode will be cancelled if you perform any of the following operations:

- Press the “RPT” button
- Press the “RDM” button
- Press the “▲” button
- Press the “^” or “√” side of the “TUNE TRACK” button
- Press the “^” or “√” side of the “SEEK FLDR” button (MP3 disc)
- Select the radio mode
- Press the “RSE AUX” button
- Turn off the power of the audio equipment.
- Turn the ignition switch to the “LOCK” position.

▼ To eject a disc from the player

When a disc is being played back or when a disc is in the player, press the “▲” button (8). The disc will be ejected.

NOTE

- Avoid driving the vehicle with a CD sticking out, because vibration might make it fall out.

- If the disc is left ejected for more than approximately 15 seconds after the ignition switch is turned to the "LOCK" position, a disc protection function will operate, automatically reloading the disc. In this case, the disc is not played.

▼ **Display selection (MP3 disc)**

If you press the "AUDIO" button (3) during playback, the indication will change to the next one in the following sequence.

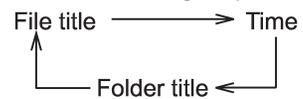

▼ **Page (track/folder title) scroll (MP3 disc)**

If, having pressed the "AUDIO" button (3) to select track title or folder title display, you press the "AUDIO" button again for less than 0.5 second, the title will be scrolled so you can see all of it. You will see eight characters at a time.

NOTE

The display is designed to show titles for up to three pages (64 characters in total).

Type B audio set (if equipped)

The audio set will operate only when the ignition switch is in the "Acc" or "ON" positions.

■ Radio operation

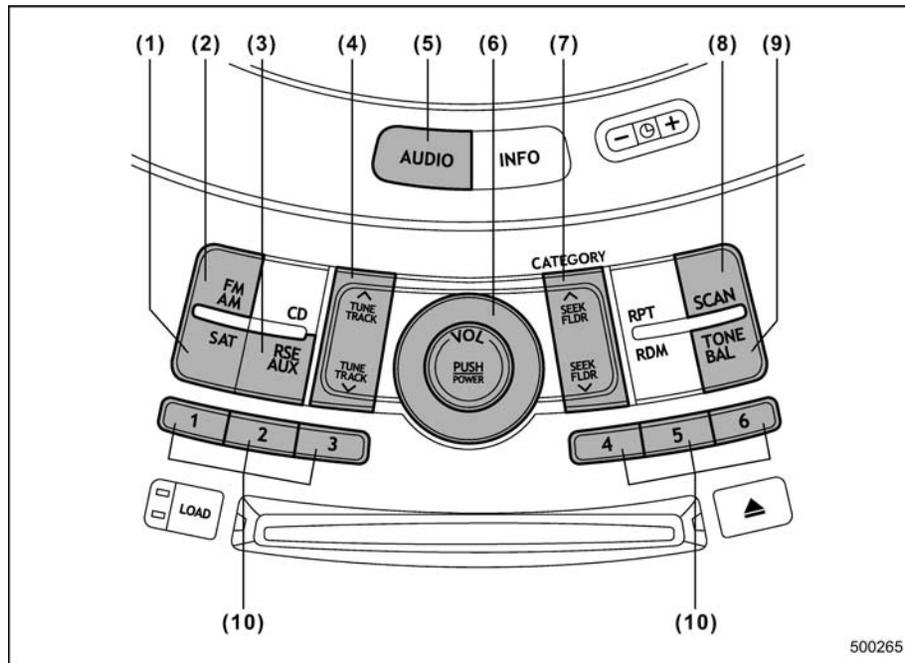

500265

- (1) Satellite radio mode button
- (2) FM AM mode button
- (3) Auxiliary unit and Rear seat entertainment button
- (4) Tuning button
- (5) AUDIO button
- (6) Power switch, volume control dial
- (7) Seek button
- (8) Scan button
- (9) Tone and Balance button
- (10) Preset button

▼ Power switch and volume control

The dial (6) is used for both power (ON/OFF) and volume control. The radio is turned ON and OFF by pushing the dial and the volume is controlled by turning the dial. The dial can also be used for tone and balance adjustment.

▼ Tone and balance control

The volume control dial (6) normally functions as a volume control. This dial becomes a control for Bass, Midrange, Treble, Fader or Balance when you select the appropriate tone and balance control mode.

Choose desired volume level for each mode by turning the volume control dial. The control function returns to volume control mode after approximately 5 seconds.

▽ **To change tone and balance control modes**

Each brief press of the "TONE BAL" button (9) changes control modes in the following sequence starting from volume control mode. (When the radio is first turned on, the control mode is in the volume control.)

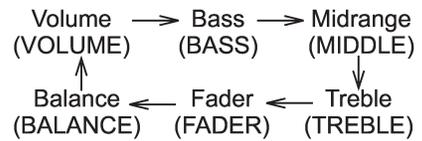

The "TONE BAL" button is used for selecting the following control modes:

5-18 Audio

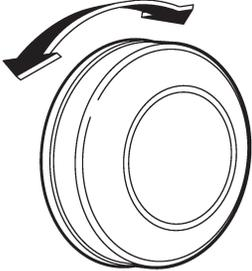
Control mode (Range of levels)		
	Turn counterclockwise	Turn clockwise
Bass control (-6 to +6)	For less bass sound	For more bass sound
Midrange control (-6 to +6)	For less midrange sound	For more midrange sound
Treble control (-6 to +6)	For less treble sound	For more treble sound
Fader control (R9 to F9)	To increase rear speaker volume and decrease front speaker volume	To increase front speaker volume and decrease rear speaker volume
Balance control (L9 to R9)	To increase left speaker volume and decrease right speaker volume	To increase right speaker volume and decrease left speaker volume
Volume control (0 to 40)	For less volume	For more volume
AUX volume control* (0 to 40)	For less volume	For more volume

* Only when an AUX audio product is connected.

▼ FM/AM radio

▽ FM/AM selection button

Push the “FM AM” button (2) when the radio is off to turn on the radio.

Push the “FM AM” button when the radio is on to select FM1, FM2 or AM reception.

▽ Stereo indicator

The stereo indicator “ST” will illuminate when an FM stereo broadcast is received.

▽ Manual tuning

Press the “^” side of the “TUNE TRACK” button (4) to increase the tuning frequency and press the tuning button marked “v” to decrease it.

Each time the button is pressed, the frequency interval can be changed between 10 kHz in the AM mode and 0.2 MHz in the FM mode.

If you hold down the “^” side of the button, the tuning frequency will increase continuously, and if you hold down the “v” side of the button, the tuning frequency will decrease continuously. Release the button when your desired frequency is reached.

NOTE

While you are holding down either side of the TUNE/TRACK button, the tuning frequency will not stop changing even if the frequency of a receivable station is reached.

▽ **Seek tuning (SEEK)**

If you press the “^” or “v” side of the “SEEK FLDR” button (7), the radio will automatically search for a receivable station and stop at the first one it finds. This function may not be available, however, when radio signals are weak. In such a situation, perform manual tuning to select the desired station.

▽ **Scan tuning (SCAN)**

Press the “SCAN” button (8) to change the radio to the SCAN mode. In this mode, the radio scans through the radio band until a station is found. The radio will stop at the station for 5 seconds while displaying the frequency, after which scanning will continue until the entire band has been scanned from the low end to the high end. Press the “SCAN” button again to cancel the SCAN mode and to stop on any displayed frequency.

Press the “^” or “v” side of the “SEEK FLDR” button (7) again to cancel the scan mode and to stop on any displayed

frequency.

When the “SCAN” button is pressed for automatic tuning, stations are scanned in the direction of low frequencies to high frequencies only.

Automatic tuning may not function properly if the station reception is weakened by distance from the station or proximity to tall buildings and hills.

▽ **Selecting preset stations**

Presetting a station with a preset button allows you to select that station in a single operation. Up to six AM, FM1 and FM2 stations each may be preset.

▽ **How to preset stations**

1. Press the “FM AM” button (2) to select FM1, FM2 or AM reception.
2. Press the “SCAN” button (8) or tune the radio manually until the desired station frequency is displayed.
3. Press one of the preset buttons for more than 1.5 seconds to store the frequency. If the button is pressed for less than 1.5 seconds, the preceding selection will remain in memory.

NOTE

● **If the connection between the radio and battery is broken for any reason such as vehicle maintenance or radio**

removal, all stations stored in the preset buttons are cleared. If this occurs, it is necessary to reset the preset buttons.

● **If a cell phone is placed near the radio, it may cause the radio to emit noise when it receives calls. This noise does not indicate a radio malfunction.**

▼ **Satellite radio mode (if equipped)**

To receive satellite radio, it is necessary to install the SUBARU genuine satellite receiver (optional part) and to enter into a contract. For details, please contact your SUBARU dealer.

▽ **Sirius satellite radio**

Sirius satellite radio is a recent innovation that allows the listener to experience digital sound quality and to have a greater variety of channels.

Use of satellite radio (Sirius) requires a tuner, antenna and a service contract. For details, please contact your SUBARU dealer or visit Sirius Satellite Radio at www.sirius.com or call 1-888-539-SIRIUS (7474) for more information. Sirius, the Sirius dog logo, channel names and logos are trademarks of SIRIUS Satellite Radio Inc.

▽ **XM™ satellite radio**

XM™ is a continental U.S. based satellite radio service including music, news, sports, talk and children's programming. XM™ provides digital quality audio and text information, including song title and artist name. A service fee is required to receive the XM™ service. For more information, contact your SUBARU dealer or XM™ at www.xmradio.com or call 1-800-XMRADIO (1-800-967-2346) for U.S. www.xmradio.ca or call 1-877-GET-XMSR (1-877-438-9677) for Canada.

▽ **Satellite radio reception**

Satellite radio signals are best received in areas with a clear view of the open sky. In areas where there are tall buildings, trees, tunnels or other structures that may obstruct the signal of the satellites, there may be signal interruptions. Other circumstances that may result in signal loss include driving near a wall, steep cliff or hill, or driving on the lower level of a multi-tiered road or inside a parking garage.

To help reduce this condition, satellite radio providers have installed ground-based repeaters in heavily populated areas. However, you may still experience reception problems in some areas.

▽ **Displaying satellite radio ID of tuner**

When you activate satellite radio, you should have your satellite radio tuner ID ready because each tuner is identified by its unique satellite radio tuner ID.

The satellite radio ID will be needed when you activate satellite radio and receive satellite radio customer support.

The satellite radio ID can be found on the audio display by tuning the channel to "0". Turn the "TUNE/TRACK" button (4) to select the satellite radio channel.

▽ **Band selection button**

Push the "SAT" button (1) when the radio is off to turn on the radio.

Push the "SAT" button when the radio is on to select SAT1, SAT2 or SAT3 reception.

▽ **Channel selection**

Press "∧" of the "TUNE TRACK" button (4) to select the next channel and press "∨" of the button to select the previous channel.

Keep pressing "∧" of the button to change to the next channel continuously and keep pressing "∨" of the button to change to the previous channel continuously.

▽ **Category selection**

Press "∧" or "∨" of the "SEEK FLDR" button (7) to display the current category. Press "∧" again to select the next category, and press "∨" again to select the previous category.

▽ **Channel scan**

Press the "SCAN" button (8) to change the radio to the SCAN mode. In this mode, the radio scans through the channels until a station is found. The radio will stop at the station for 5 seconds while displaying the channel number, after which scanning will continue until the entire channel has been scanned from the low end to the high end. Also during the category selection, channel scan can be performed in that category.

Press the "SCAN" button again to cancel the SCAN mode and to stop on any displayed channel.

▽ **Selecting preset channels**

Presetting a channel with a preset button (10) allows you to select that channel in a single operation. Up to six, SAT1, SAT2 and SAT3 channels each may be preset.

▽ **How to preset channels**

1. Press the "SAT" button (1) to select SAT1, SAT2 and SAT3 reception.

2. Press the “SCAN” button (8) or the “TUNE TRACK” button (4) to select the channel.
3. Press one of the preset buttons (10) for more than 1.5 seconds to store the channel. If the button is pressed for less than 1.5 seconds, the preceding selection will remain in memory.

NOTE

If the connection between the radio and battery is broken for any reason such as vehicle maintenance or radio removal, all channels stored in the preset buttons are cleared. If this occurs, it is necessary to reset the preset buttons.

▽ **Display selection**

Press the “AUDIO” button (5) while receiving satellite radio to change the display as follows:

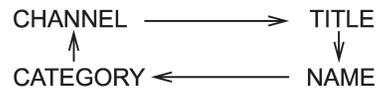

▼ **Rear seat entertainment**

If your vehicle is equipped with a Rear Seat Entertainment System, you can enjoy audio outputs from the system through the vehicle’s speakers by pressing the “RSE AUX” button (3). Press the

button again to return to the audio set sound.

NOTE

If your vehicle is equipped with a Rear Seat Entertainment System, refer to the Owner’s Manual supplement for the Rear Seat Entertainment System for further details.



■ Built in CD changer operation

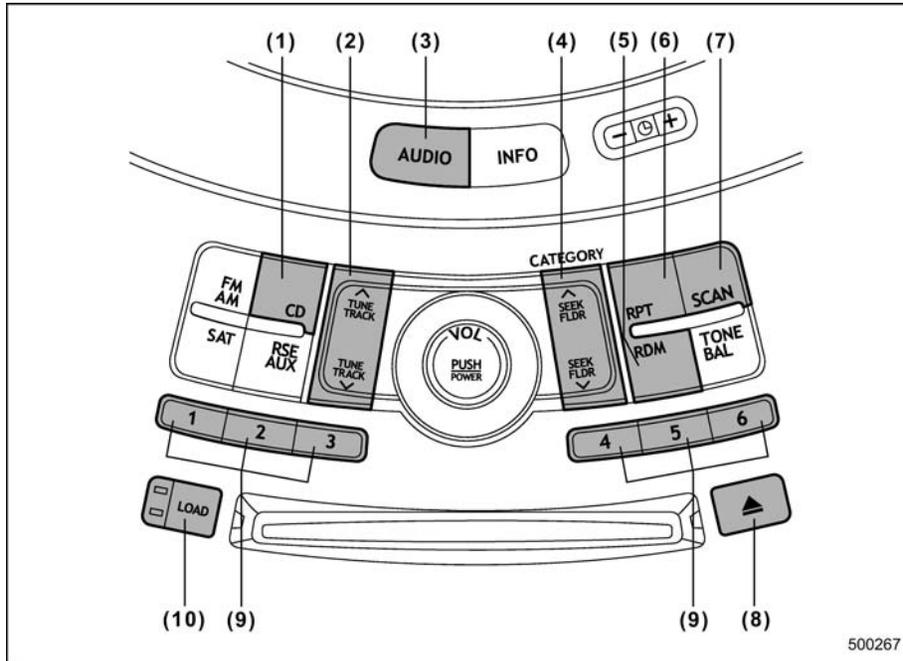

- (1) CD button
- (2) Track button
- (3) AUDIO button
- (4) Seek and Folder button
- (5) Random button
- (6) Repeat button
- (7) Scan button
- (8) Eject button
- (9) Disc select button
- (10) Load button

NOTE

- Be sure to insert a disc with the label side up. If you insert the disc the label side down, "CHECK DISC" will appear on the display and the player will not play anything.
- If a disc is inserted during a radio broadcast, the disc will interrupt the broadcast.
- The player is designed to be able to play music CD-Rs and music CD-RWs, but it may not be able to play certain ones.
- CDs (i.e., 8 cm/3 inch CDs) are not supported, and if inserted, they will be immediately ejected.
- Insert discs slowly, one at a time. Inserting discs one over another could result in malfunction of the CD changer.

▼ How to insert a CD(s)

▽ Inserting a CD

1. Briefly press the “LOAD” button (10). If the magazine in the player has an idle position where you can insert a disc, the disc number indicator associated with the idle position will blink.

If no indicator blinks, it means that there is no idle position in the magazine.

2. After the disc number indicator has started to flash, insert the disc when “LOAD” flashes on the display. The disc will then be automatically drawn in, and the player will begin to play back the first track of the disc.

- To insert more discs in succession, repeat Steps 1 and 2. The magazine will be loaded with discs in the ascending order of position number.

If you do not insert any disc in 15 seconds after you have pressed the “LOAD” button, the player will begin to play back the first track of the last disc you have inserted.

- The disc indicator steadily lights up if a disc is already inserted in the corresponding position of the magazine.

- While the player is in the loading mode, if you press “FM AM” button, the player will enter the standby mode. Press the “CD” button (1) to start playback.

▽ Inserting a disc in a desired position

1. Briefly press the “LOAD” button (10). If the magazine in the player has an idle position where you can insert a disc, the disc number indicator associated with the idle position will blink.

The positions in the magazine the indicator of which steadily lights up are already loaded with discs.

2. Press the disc select button (9) at the position where you want to insert a disc.

3. Insert the disc when “LOAD” flashes on the display. The disc will then be automatically drawn in, and the player will begin to play the first track on the disc.

- If you wish to insert another disc, repeat the procedure beginning with step 1.

If you do not insert any disc in 15 seconds after you have pressed the “LOAD” button, the player will begin to play back the first track of the last disc you have inserted.

- While the player is in the loading mode, if you press “FM AM” button, the player will enter standby mode. Press the “CD” button (1) to start playback.

▽ Loading all the magazine (full disc loading mode)

1. If you continue to press the “LOAD”

button (10) for more than 1.5 seconds, the player will produce beep sound and will enter the full disc loading mode.

2. A “disc number” indicator will blink, and “ALL LOAD” will be on display for a period of 15 seconds. If a disc is successfully loaded during this period, the disc number indicator will stop blinking and will steadily light.

3. When the loading of a disc is complete, the next disc number indicator will blink. Then repeat Step 2.

4. When the magazine is filled with discs by repeating Steps 2 and 3, the player will start playback of the discs, beginning with the one inserted first.

If you fail to insert any disc during each 15 seconds interval, the full disc loading mode will be canceled, and the player will start playback of the disc inserted first.

▼ How to play back a CD or make a pause

▽ When there is no CD inserted:

Insert a CD by referring to “How to insert a CD(s)”.

When a CD is loaded, the player will start playback of the CD, beginning with the first track.

▽ **When there are CDs loaded:**

Press a desired one of the disc select buttons (9) the disc number indicator of which steadily lights up. The player will then start playback of the selected CD, beginning with the first track.

If a disc that the player cannot read has been loaded, "CHECK DISC" will appear on the display and the player will not play anything.

▼ **To select a song from its beginning**

▽ **Forward direction**

Briefly press the "∧" side of the "TUNE TRACK" button (2) to skip to the beginning of the next track/file (track). Each time the button is pressed, the indicated track/file (track) number will increase.

NOTE

In an MP3 folder, skipping past the last track/file (track) will take you back to the first track/file (track) in the folder.

▽ **Backward direction**

Briefly press the "∨" side of the "TUNE TRACK" button (2) to skip to the beginning of the current track/file (track). Each time the button is pressed, the indicated track/file (track) number will decrease.

NOTE

In an MP3 folder, skipping past the first track/file (track) will take you to the last track/file (track) in the folder.

▼ **Fast-forwarding and fast-reversing**

▽ **Fast-forwarding**

Press the "∧" side of the "TUNE TRACK" button (2) continuously to fast-forward the track/file.

Release the button to stop fast-forwarding.

NOTE

If you fast-forward to the end of the last track/file (track), fast-forwarding will stop and the player will start playback beginning with the first track/file (track).

▽ **Fast-reversing**

Press the "∨" side of the "TUNE TRACK" button (2) continuously to fast-reverse the track/file.

Release the button to stop fast-reversing.

NOTE

If you fast-reverse to the beginning of the first track/file (track), fast-reversing will stop and the player will start playback.

▼ **Repeating**

▽ **To repeat the currently playing track/file (track)**

To repeat a track/file (track), briefly press the "RPT" button (6) while the track/file (track) is playing. The display will show "RPT", and the track/file (track) will be repeated.

To cancel the track/file (track) repeat-play mode, briefly press the "RPT" button twice. The "RPT" indication will turn off, and the normal playback mode will be resumed.

NOTE

• Each time you briefly press the button, the mode will change to the next one in the following sequence.

RPT → D-RPT → CANCEL



If you accidentally press the button and cancel the track/file (track) repeat-play mode, press it again to reselect the repeat-play mode.

• The repeat-play mode will be cancelled if you perform any of the following steps:

- Press the "RDM" button
- Press the "SCAN" button
- Press the "▲" button

- Press the disc select button
- Select the radio mode
- Press the “RSE AUX” button
- Press the “∨” or “∧” side of the “SEEK FLDR” button (MP3 disc)
- Turn off the power of the audio equipment.
- Turn the ignition switch to the “LOCK” position.

▽ To repeat the currently playing disc/folder

To repeat the currently playing disc/folder, press the “RPT” button (6) twice while a track/file (track) is playing. The display will show “D-RPT”, and the disc/folder will be played repeatedly.

To cancel the disc/folder repeat-play mode, press the “RPT” button once more. The “D-RPT” indication will turn off, and the normal playback mode will be resumed.

NOTE

- Each time you briefly press the button, the mode will change to the next one in the following sequence.

RPT → D-RPT → CANCEL

If you accidentally press the button and cancel the disc/folder repeat-play

mode, press it again to reselect the disc/folder repeat-play mode.

- The disc/folder repeat-play mode will be cancelled if you perform any of the following steps:

- Press the “RDM” button
- Press the “SCAN” button
- Press the “▲” button
- Press the disc select button
- Select the radio mode
- Press the “RSE AUX” button
- Press the “∨” or “∧” side of the “SEEK FLDR” button (MP3 disc)
- Turn off the power of the audio equipment.
- Turn the ignition switch to the “LOCK” position.

▼ Random playback

▽ Non-MP3 disc

Press the “RDM” button (5) briefly during disc playback to play all of the tracks on the disc in a random order. The display will show “RDM”, and all of the tracks on the disc will be played in a random order.

To cancel random mode, press the button again. The “RDM” indication will turn off, and the normal playback mode will be resumed.

NOTE

Random playback will be cancelled if you perform any of the following steps:

- Press the “RPT” button
- Press the “SCAN” button
- Press the “▲” button
- Select the radio mode
- Press the “RSE AUX” button
- Press the “∨” or “∧” side of the “SEEK FLDR” button
- Turn off the power of the audio equipment.
- Turn the ignition switch to the “LOCK” position.

▽ MP3 disc

Press the “RDM” button (5) during disc playback to play all of the tracks in the folder currently being played in random order. Press the “RDM” button again to play all of the tracks on the disc in random order. The display will show “RDM” during the random mode.

To cancel the random mode, press the “RDM” button during “in-disc” random playback. The “RDM” indication will turn off, and the normal playback mode will be resumed.

NOTE

- Each time you briefly press the button, the mode will change to the

next one in the following sequence.
 "In-folder" random playback → "In-disc" random playback



If you accidentally press the button and cancel the random mode, press it again to reselect the random mode.

• Random playback will be cancelled if you perform any of the following steps:

- Press the "RPT" button
- Press the "SCAN" button
- Press the "▲" button
- Select the radio mode
- Press the "RSE AUX" button
- Press the "√" or "∧" side of the "SEEK FLDR" button
- Turn off the power of the audio equipment.
- Turn the ignition switch to the "LOCK" position.

▼ SCAN

The scan mode lets you listen to the first 10 seconds of each track/file (track) in succession. Press the "SCAN" button (7) to start scanning upward beginning with the track/file (track) following the currently selected one. When all tracks/files (tracks) in the disc/folder have been scanned,

normal playback will be resumed. To cancel the scan mode, press the button again.

NOTE

The scan mode will be cancelled if you perform any of the following steps:

- Press the "RPT" button
- Press the "RDM" button
- Press the "√" or "∧" side of the "TUNE TRACK" button
- Press the "√" or "∧" side of the "SEEK FLDR" button (MP3 disc)
- Press the "▲" button
- Press the disc select button
- Select the radio mode
- Press the "RSE AUX" button
- Turn off the power of the audio equipment.
- Turn the ignition switch to the "LOCK" position.

▼ Display selection (MP3 disc)

If you press the "AUDIO" button (3) during playback, the indication will change to the next one in the following sequence.



▼ Page (track/folder title) scroll (MP3 disc)

If, having pressed the "AUDIO" button (3) to select track title or folder title display, you press the "AUDIO" button again for less than 0.5 second, the title will be scrolled so you can see all of it. You will see eight characters at a time.

NOTE

The display is designed to show titles for up to three pages (64 characters in total).

▼ Folder selection (MP3 disc)

Press the "∧" side of the "SEEK FLDR" button (4) briefly to select the next folder. Pressing the "√" side of the same button the first time makes the player go back to the beginning of the currently selected file; pressing it a second time makes it go back to the previously selected file.

NOTE

Only MP3 folders are recognized when an attempt to select the next or previous folder is made. If no appropriate folder exists on the disc, pressing the "∧" or "√" side of the "SEEK FLDR" button has no effect.

▼ **How to unload CDs from the player**

▽ **Ejecting a CD from the player**

Of the discs loaded, you can select and remove only one disc.

1. Use the disc select button (9) to select the disc to be ejected.
2. Briefly press the “▲” button (8). The selected disc will be ejected. The disc number indicator will flash at this time. When you remove the ejected disc, the disc number indicator will turn off.

To remove more discs in succession, repeat Steps 1 and 2.

▽ **Ejecting all discs from the player (all disc ejection mode)**

1. If you continue to press the “▲” button (8), the player will produce beep sound and will enter the all disc ejection mode.
2. Remove the disc that has been ejected. The other discs loaded will then be ejected one after another. If you do not remove the disc that has been ejected, the “All disc ejection mode” will be canceled.

NOTE

- **Avoid driving the vehicle with a CD sticking out, because vibration might make it fall out.**
- **If you press the “▲” button while**

the player is in all disc ejection mode, the mode will be cancelled following ejection of the disc that is currently being ejected.

- **If you press the “CD” button while the player is in all disc ejection mode, the player will draw in the discs that have been ejected and play them.**

Audio control buttons

These buttons are located on the spokes of the steering wheel. They allow the driver to control audio functions without taking his/her hands off the steering wheel.

■ **MODE button**

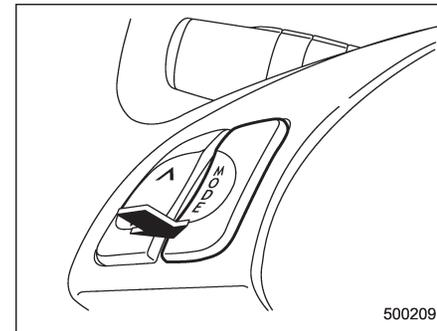

This button is used to select the desired audio mode. Each time it is pressed, the mode changes to the next one in the following sequence:

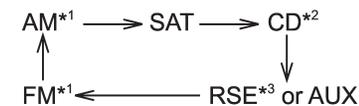

*1: The frequency last received in the selected

5-28 Audio

waveband will be displayed.

*2: Only when a CD is in the player.

*3: Only vehicle equipped with RSE (Rear Seat Entertainment)

▼ “^” and “v” buttons

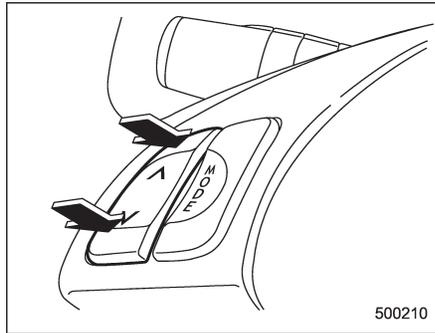

▽ With radio mode selected

Press the “^” button to select the next channel and press the “v” button to select the previous channel.

That station’s frequency will be shown on the audio display.

▽ With CD mode selected

Press the “^” button to skip forward in the track/file (track) order. Pressing the “v” button the first time makes the player go back to the beginning of the current track/

file (track); pressing it the second time makes it go back to the previous track/file (track).

The track/file (track) number will be shown on the audio display.

▼ Volume control buttons

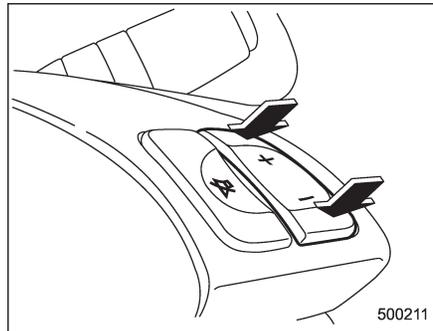

Press the “+” button to increase the volume. Press the “-” button to reduce the volume.

A number indicating the volume will be shown on the audio display.

▼ MUTE button

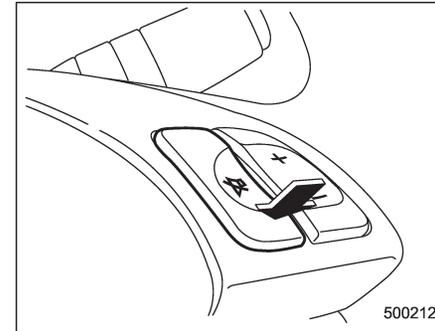

Press this button if you wish to immediately cut the volume to zero.

The audio display will show “MUTE”.

If you press the button again, the original sound volume will return and “MUTE” turns off.

NOTE

If your vehicle is equipped with a genuine SUBARU navigation system, the display will show “M”.

Aux unit operation

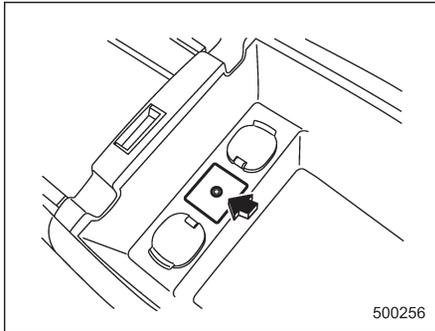

By connecting a commercial audio product to the vehicle, such as a portable audio player, you can hear its sound via the vehicle's speaker.

Connect the portable audio player and push the "RSE AUX" button.

For the audio input terminal, a stereo mini pin plug (3.5φ) can be connected. For detailed information, see the Owner's Guide for the portable audio player.

NOTE

- The output sound of the portable audio player is not loud, and the sound via the vehicle's speakers that are connected to the vehicle audio set is very quiet. If you turn up the volume of

the audio set, the volume becomes louder. However, when you change the audio to the radio mode or to a CD player, the sound becomes a lot louder. Remember to turn down the volume when you change between them.

- In some cases, when the sound volume of the portable audio player is low, the sound becomes bad when you turn up the volume of the vehicle audio system. In this case, adjust the sound volume of the portable audio player.
- In some cases, noise occurs because of a bad connection between the portable player of the vehicle audio system or for the player.

Rear Seat Entertainment (RSE) system operation (if equipped)

If your vehicle is equipped with the Rear Seat Entertainment (RSE) system, you can listen to the audio via the vehicle speakers. Push the "RSE AUX" button to play a DVD using the Rear Seat Entertainment system.

For detailed operating procedures, refer to the Owner's Manual supplement for the Rear Seat Entertainment (RSE) system.

NOTE

To watch a DVD in the front seats using the monitor of the navigation system, park the vehicle in a safe location and apply the parking brake. Images of the DVD will not be displayed on the front monitor unless the parking brake is applied.

Precautions to observe when handling a compact disc

Use only compact discs (CDs, CD-Rs and CD-RWs) that have the mark shown in the following illustration. Also, some compact discs cannot be played.

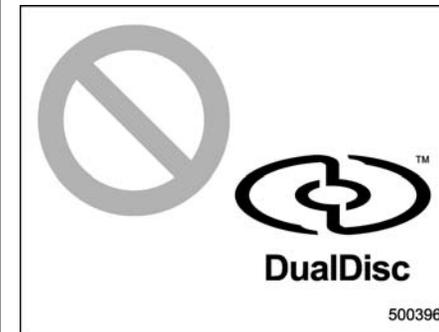
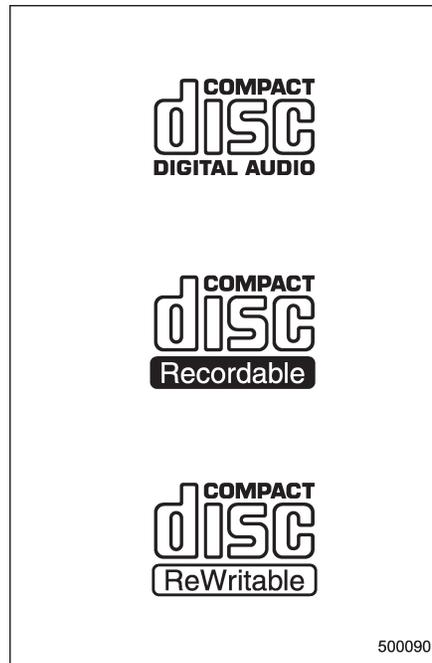

- You cannot use a DualDisc in the CD player. If you insert a DualDisc into the player, the disc may not come out again, possibly causing the player to malfunction.
- In cold and/or rainy weather, dew can form inside the CD player, preventing normal operation. If this happens, eject the CD and wait for the player to dry out.
- Skipping may occur when the CD player is subjected to severe vibration (for example, when the vehicle is driven on a rough surface).
- To remove a disc from the case, press the center of the case and hold both edges of the disc. If the disc surface is touched directly, contamination could cause poor tone quality. Do not touch the disc surface.
- Use a clean disc whenever possible. If

there are deposits, wipe the disc surface from the center outward with a dry, soft cloth. Be sure not to use a hard cloth, thinner, benzine, alcohol, etc.

- Do not use any disc that is scratched, deformed, or cracked. Also, do not use any disc that has a non-standard shape (for example, a heart shape). Malfunctions or problems might result.
- A disc is vulnerable to heat. Never keep it either in places exposed to direct sunlight, near heaters or in vehicles parked in the sun or on hot days.

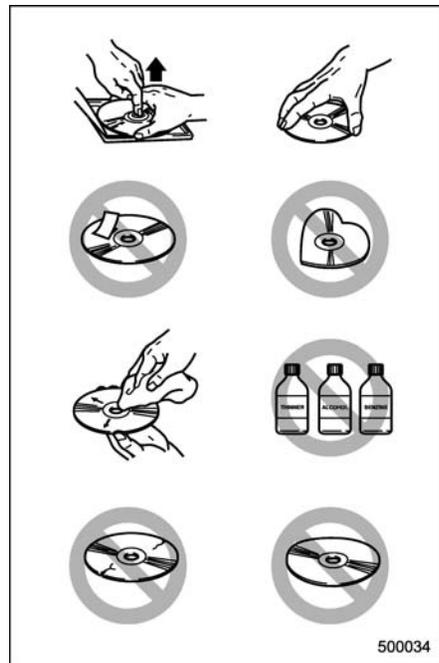

Interior equipment

Interior light	6-2		
Dome light	6-2		
Cargo area light	6-2		
Rear gate light	6-3		
Map light.....	6-3		
Automatic ambient light for center console area (if equipped).....	6-3		
Sun visors	6-4		
Sun visor extension plate	6-4		
Vanity mirror with light	6-4		
Storage compartment	6-5		
Glove box	6-5		
Center console box	6-6		
Rear console.....	6-7		
Overhead console	6-7		
Cup holder	6-7		
Front passenger's cup holder.....	6-7		
Rear seat (5-seater models)/Second-row seat (7-seater models) passenger's cup holder.....	6-8		
Third-row seat cup holders (7-seater models).....	6-8		
Bottle holders	6-9		
Accessory power outlets	6-9		
Coat hook	6-11		
Shopping bag hook	6-12		
Floor mat	6-12		
Cargo area cover (if equipped)	6-13		
Using the cover.....	6-13		
		To remove the cover	6-14
		To install the cover housing	6-14
		Convenient tie-down hooks	6-15
		Under-floor storage compartment	6-15
		5-seater models	6-15
		7-seater models	6-16
		HomeLink® Wireless Control System (if equipped)	6-16
		Garage door opener programming in the U.S.A.....	6-17
		Programming rolling-code-protected garage door openers in the U.S.A.	6-18
		Programming for entrance gates and garage door openers in Canada.....	6-19
		Programming other devices	6-20
		Operating the HomeLink® Wireless Control System.....	6-20
		Reprogramming a single HomeLink® button.....	6-20
		Erasing HomeLink® button memory	6-20
		In case a problem occurs.....	6-20
		Rear view camera (if equipped)	6-21
		Position of rear view camera.....	6-22
		How to use the rear view camera	6-22
		Viewing range on the screen.....	6-22
		Distance marker (help line)	6-24

6-2 Interior equipment

Interior light

When leaving your vehicle, make sure the light is turned off to avoid battery discharge.

■ Dome light

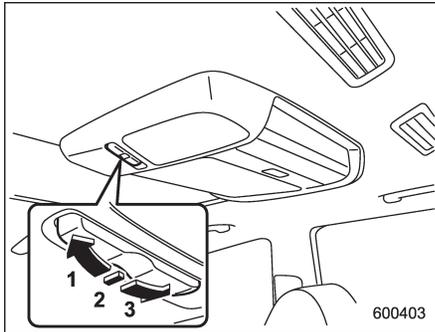

Vehicles with Rear Seat Entertainment

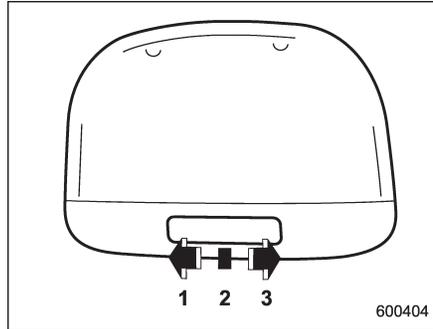

Vehicles without Rear Seat Entertainment

- 1) ON
- 2) DOOR
- 3) OFF

The light switch has three positions:

ON: The light stays on continuously.

OFF: The light stays off.

DOOR: The light illuminates when any door is opened. The light remains illuminated for several seconds and gradually turns off after all doors are closed.

The light also can be turned on by use of the remote keyless entry transmitter. Refer to "Remote keyless entry system" in chapter 2 for detailed information.

The setting of the period for which the light stays on can be changed by a SUBARU dealer.

Contact the nearest SUBARU dealer for details.

■ Cargo area light

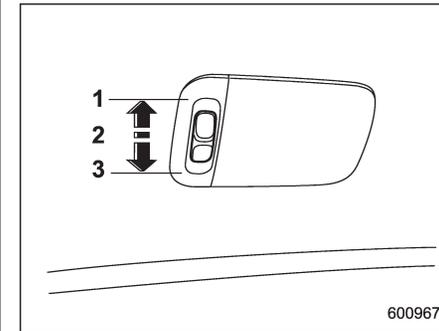

- 1) DOOR
- 2) OFF
- 3) ON

The cargo area light switch has three positions:

DOOR: The light illuminates only when the rear gate is opened.

OFF: The light stays off.

ON: The light stays on continuously.

■ Rear gate light

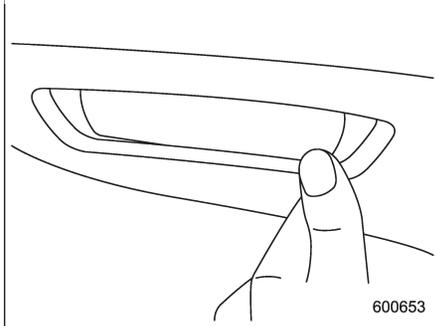
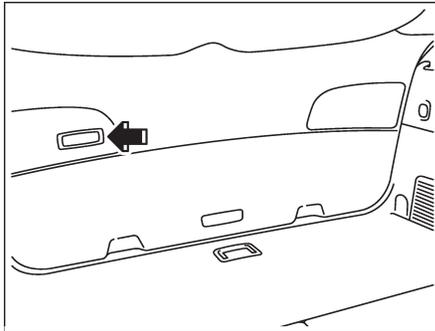

The rear gate light is located inside the vehicle on the rear gate. Push the right side of the switch to turn it on, and push the left side of the switch to turn it off.

■ Map light

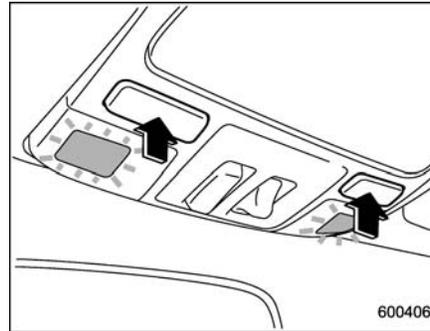

To turn on the map light, push the switch. To turn it off, push the switch again.

When leaving the vehicle, make sure the light is turned off to avoid battery discharge.

The light also can be turned on by use of the remote keyless entry transmitter. Refer to "Remote keyless entry system" in chapter 2 for detailed information.

The setting of the period for which the light stays on can be changed by a SUBARU dealer.

Contact the nearest SUBARU dealer for details.

■ Automatic ambient light for center console area (if equipped)

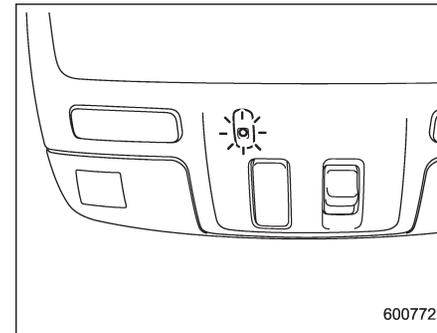

The automatic ambient light illuminates when the ignition switch is in the "ON" position and the light control switch is in the "DOGS" position or "D" position. The light dimly illuminates the area around the center console. The light turns off when the light control switch is in the "OFF" position. Also, the brightness of the light is adjusted by the illumination brightness control dial.

Sun visors

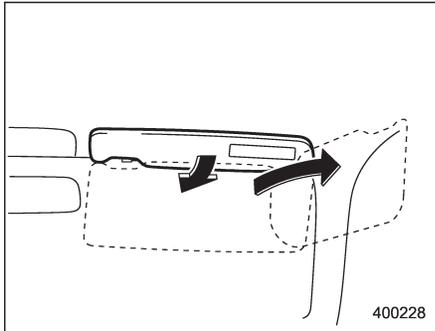

To block out glare, swing down the visors. To use the sun visor at a side window, swing it down and move it sideways.

■ Sun visor extension plate

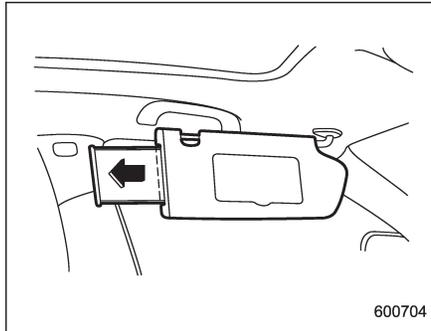

With the sun visor positioned over the side window, you can use the sun visor extension plate to prevent glare through the gap between the sun visor and center pillar. To use the extension plate, pull it toward the rear of the vehicle. When you have finished using it, stow it by pushing it toward the front of the vehicle.

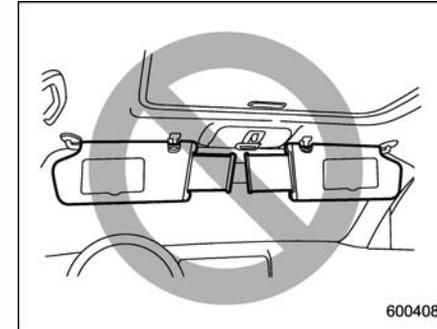

▲ CAUTION

Do not pull out the extension plate with the sun visor positioned over the windshield. The extension plate would obstruct your view of the rearview mirror.

■ Vanity mirror with light

▲ CAUTION

Keep the vanity mirror cover closed while the car is being driven to avoid dazzle.

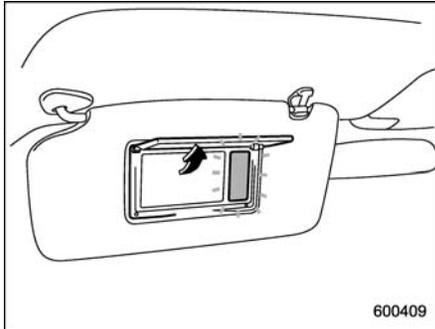

To use the vanity mirror, swing down the sun visor and open the vanity mirror cover. The light beside the vanity mirror illuminates when the mirror cover is opened.

NOTE

Use of the vanity mirror light for a long period of time while the engine is not running can cause battery discharge.

Storage compartment

CAUTION

- Always keep the storage compartment closed while driving to reduce the risk of injury in the event of sudden stops or an accident.
- Do not store spray cans, containers with flammable or corrosive liquids or any other dangerous items in the storage compartment.

■ Glove box

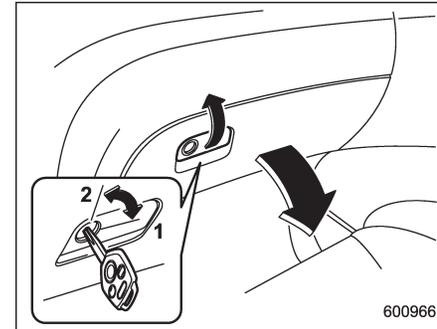

- 1) Lock
- 2) Unlock

To open the glove box, pull the handle. To close it, push the lid firmly upward.

To lock the glove box, insert the key and turn it clockwise. To unlock the glove box, insert the key and turn it counterclockwise.

6-6 Interior equipment

■ Center console box

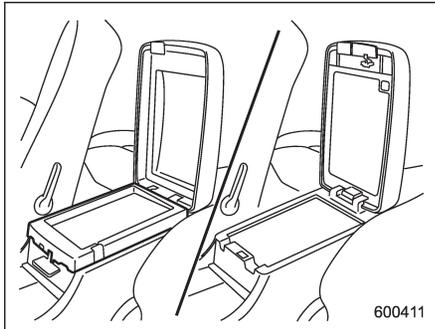

The center console box has a two-layer structure consisting of an upper compartment and a lower compartment.

▼ Upper compartment

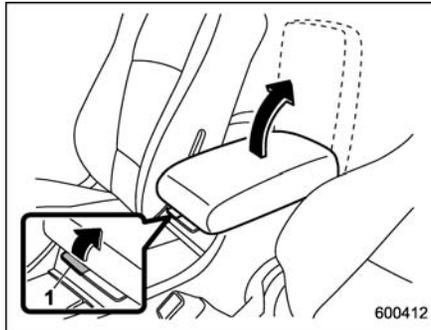

- 1) Upper compartment lock release

Pull up the upper compartment lock release to open the upper compartment.

▼ Lower compartment

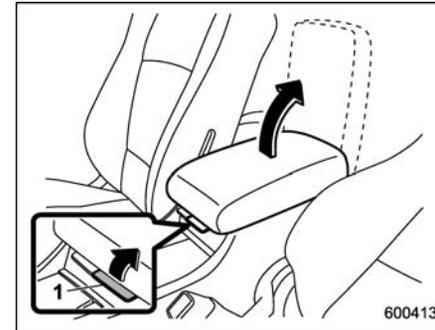

- 1) Lower compartment lock release

Pull up the lower compartment lock release to open the lower compartment.

■ Rear console

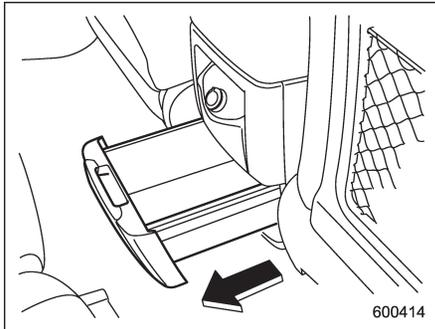

The rear console is located in the back of the center console box. Pull it out to use it.

■ Overhead console

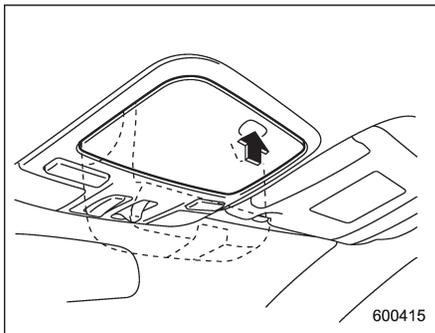

To open the console, push on the lid lightly and it will automatically open.

⚠ CAUTION

When your vehicle is parked in the sun or on a warm day, the inside of the overhead console heats up. Avoid storing plastic or other heat-vulnerable or flammable articles such as a lighter in the overhead console.

Cup holder

⚠ CAUTION

Take care to avoid spills. Beverages, if hot, might burn you or your passengers. Spilled beverages may also damage upholstery or carpets.

■ Front passenger's cup holder

⚠ CAUTION

Do not pick up a cup from the cup holder or put a cup in the holder while you are driving, as this may distract you and lead to an accident.

6-8 Interior equipment

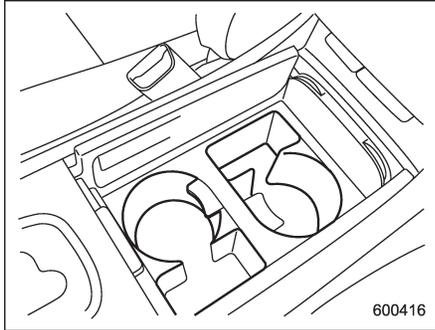

The dual cup holder is built into the center console near the selector lever.

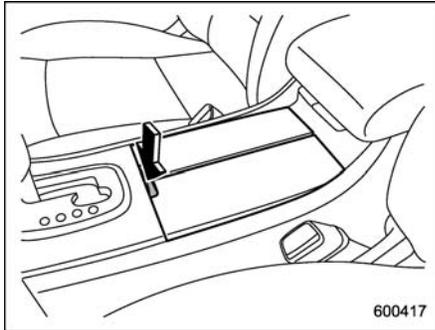

To access the cup holder, push the release button.

**■ Rear seat (5-seater models)/
Second-row seat (7-seater
models) passenger's cup
holder**

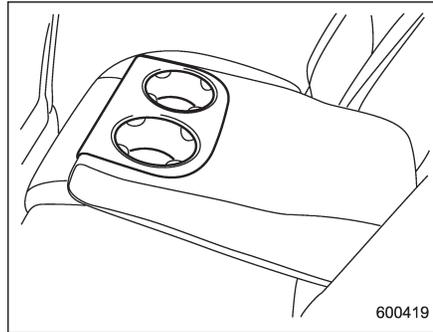

A dual cup holder is built in the armrest.

⚠ CAUTION

When a cup containing a beverage is in the cup holder, do not slide or recline any seat. Otherwise, the beverage could spill while driving and, if the beverage is hot, it could scald you.

**■ Third-row seat cup holders
(7-seater models)**

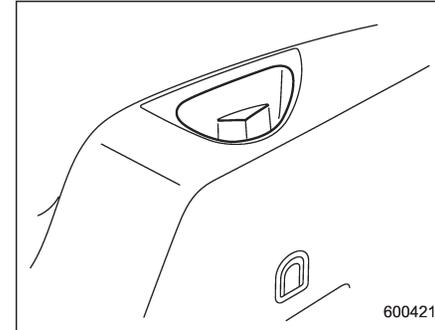

A cup holder is located at each side of the third-row seat.

⚠ CAUTION

When placing a beverage in a cup holder, make sure it is capped. Otherwise, the beverage could spill while driving and, if the beverage is hot, it could scald you.

Bottle holders

CAUTION

- Do not pick up a bottle from the bottle holder or put a bottle in the holder while you are driving, as this may distract you and lead to an accident.
- When placing a beverage in a door pocket, make sure it is capped. Otherwise, the beverage could spill when opening/closing the door or while driving and, if the beverage is hot, it could scald you.

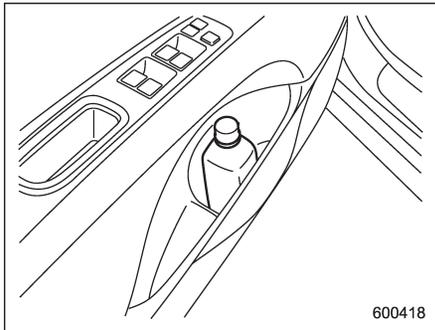

The door pocket equipped on each door

trim can be used to hold beverage bottles and other items.

Accessory power outlets

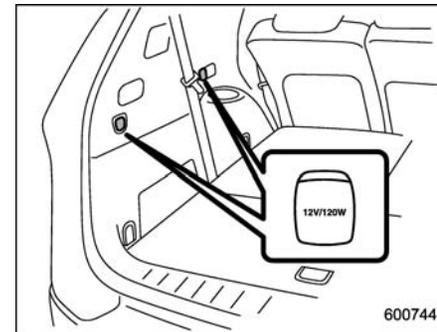
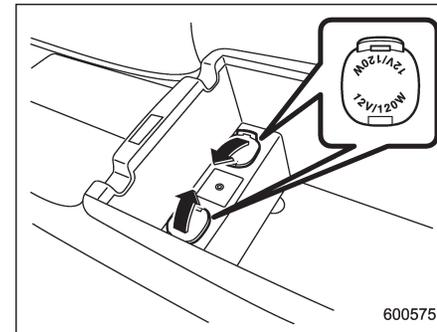

Accessory power outlets are provided in the center console (lower compartment) and in the cargo area.

– CONTINUED –

6-10 Interior equipment

Electrical power (12V DC) from the battery is available at any of the outlets when the ignition switch is either in the "Acc" or "ON" position.

You can use an in-vehicle use electrical appliance by connecting it to an outlet.

When both outlets are used at the same time, the total power consumption of the electric appliances must be 120W or less.

CAUTION

- Do not attempt to use a cigarette lighter in the accessory power outlet.
- Do not place any foreign objects, especially metal ones such as coins or aluminum foil, into the accessory power outlet. That could cause a short circuit. Always put the cap on the accessory power outlet when it is not in use.
- Use only electrical appliances which are designed for 12V DC and which consume less than 120W. Overloading the accessory power outlet can cause a short circuit. Do not use double adapters or more than one electrical appliance.
- If the plug on your electric appli-

ance is either too loose or too tight for the accessory power outlet, this can result in a poor contact or cause the plug to get stuck. Only use plugs that fit properly.

- Use of an electric appliance in the accessory power outlet for a long period of time while the engine is not running can cause battery discharge.
- Before driving your vehicle, make sure that the plug and the cord on your electrical appliance will not interfere with your shifting gears and operating the accelerator and brake pedals. If they do, do not use the electrical appliance while driving.

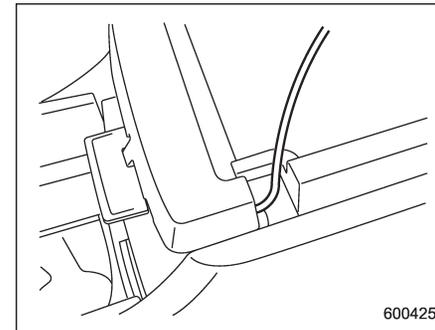
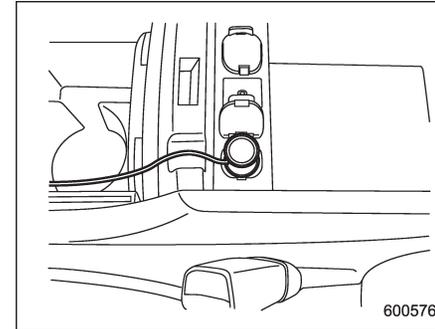

NOTE

It is possible, when using the outlet in the center console (lower compartment) with the lid closed, to pass the electrical appliance's cord through a gap between the center console (lower

compartment) and the lid. It is also possible to pass the cord through a groove in the lid and up to the center console (upper compartment).

Coat hook

A coat hook is attached to each of the passenger hand grips for the seat listed in the following.

- 5-seater models: Rear seat
- 7-seater models: Second seat

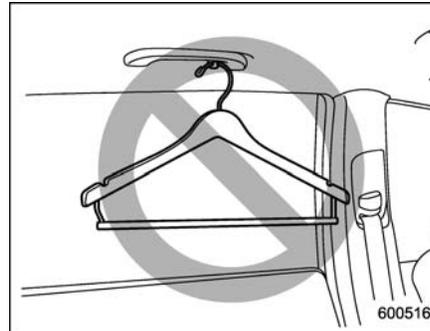

WARNING

Do not hang coat hangers or other hard or pointed objects on the coat hooks. If such items were hanging on the coat hooks during deployment of the SRS curtain airbags, they could cause serious injuries by coming off the coat hooks and being thrown through the cabin or by preventing correct airbag deploy-

ment. Before hanging clothing on the coat hooks, make sure there are no pointed objects in the pockets. Hang clothing directly on the coat hooks without using hangers.

CAUTION

Never hang anything on the coat hook that might obstruct the driver's view or that could cause injury in sudden stops or in a collision. And do not hang items on the coat hook that weigh 11 lbs (5 kg) or more.

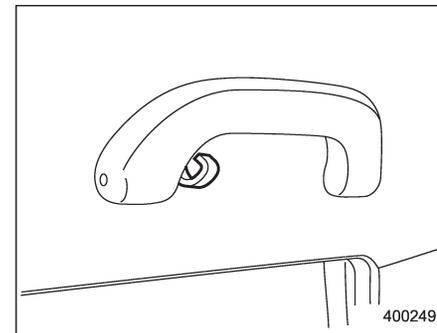

6-12 Interior equipment

Shopping bag hook

CAUTION

Do not hang items on the shopping bag hook that weigh 11 lbs (5 kg) or more.

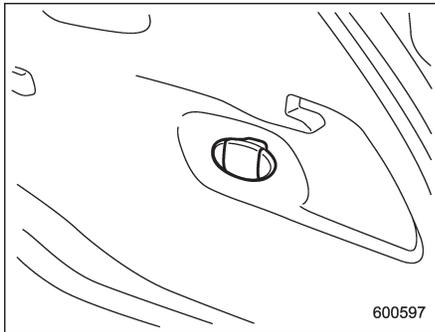

A shopping bag hook is attached to each side of the cargo area.

Floor mat

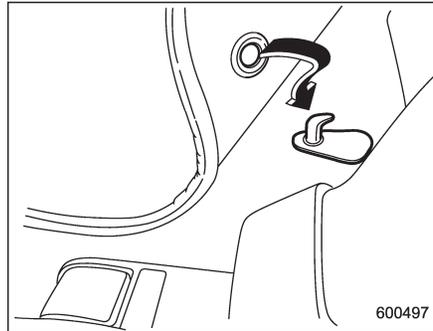

A retaining pin is located on the driver's side of the vehicle next to the fuel filler door release. Fit the grommet in the carpet onto the pin to prevent the carpet from moving.



CAUTION

Make sure the driver's floor mat is placed back in its proper location and correctly secured on its retaining pin. Also, do not use more than one floor mat. If the floor mat slips forward and interferes with the movement of the pedals during driving, it could cause an accident.

Cargo area cover (if equipped)

The cargo area cover is provided for covering the cargo area and to protect its contents from direct sunlight. This cover is detachable to make room for additional cargo.

■ Using the cover

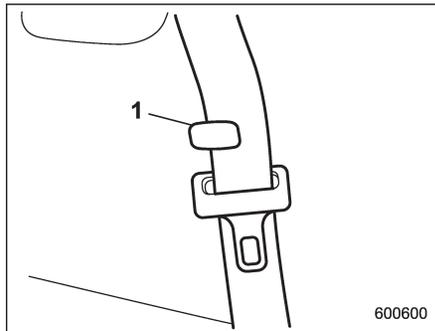

1) Holder

Insert the seat belt webbing to the holder of the third-row seat. (7-seater models)

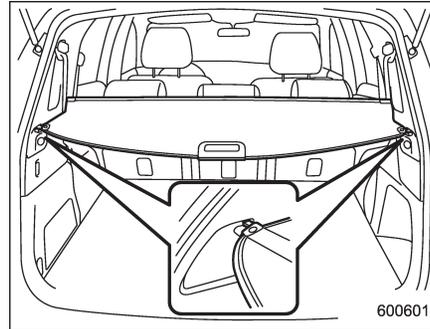

To extend the cover, pull the end of the cover out of the housing, then insert its hooks into the catches as shown. To rewind it, unhook it from the catches and it will rewind automatically. You should hold on to the cover and guide it back into the cover housing while it is rewinding.

⚠ WARNING

Do not place anything on the extended cover. Putting excessive weight on the extended cover can break it and an object on the cover could tumble forward in the event of a sudden stop or collision. This could cause serious injury.

⚠ CAUTION

- Be careful not to pinch your hand between the headrest and the cargo area cover when you recline the rear seat.
- Be careful not to scratch the rear gate stays while extending and rewinding the cover.

Scratches on the stays could cause leakage of gas from the stays, which may result in their inability to hold the rear gate open.

NOTE

When the head restraint is adjusted at the rearmost position of the seat with the seatback leaned back, the head restraint comes in contact with the cargo area cover. In this case, raise the seatback before adjusting the head restraint.

If the head restraint is correctly fixed in any of the lock positions, the head restraint does not contact the cargo area cover even when the seatback is reclined.

– CONTINUED –

6-14 Interior equipment

■ To remove the cover

1. Rewind the cover.

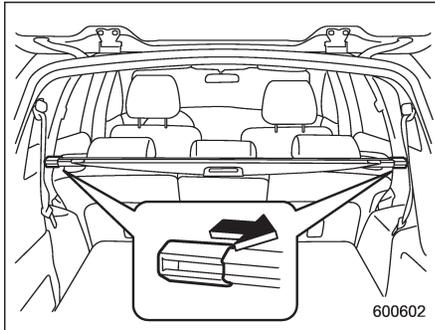

2. Pull either sleeve on the end of the cover housing to shorten the cover's length.
3. Take it off the retainer.

■ To install the cover housing

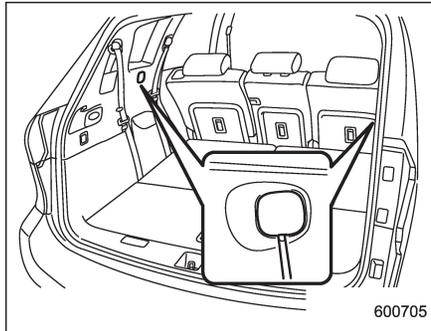

1. Remove the cover at the cover housing retaining part using a flat-head screwdriver.
2. Pull either sleeve on the end of the cover housing to shorten the cover's length.

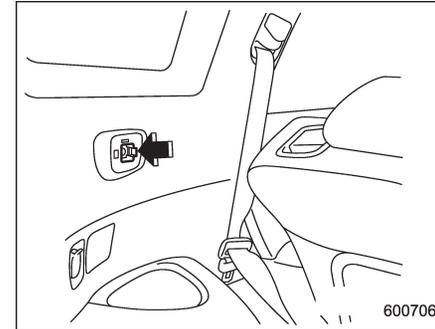

3. Insert the projections located on the both ends of the sleeve into the recesses of the retainers.

Convenient tie-down hooks

CAUTION

The convenient tie-down hooks are designed only for securing light cargo. Never try to secure cargo that exceeds the capacity of the hooks. The maximum load capacity is 44 lbs (20 kg) per hook.

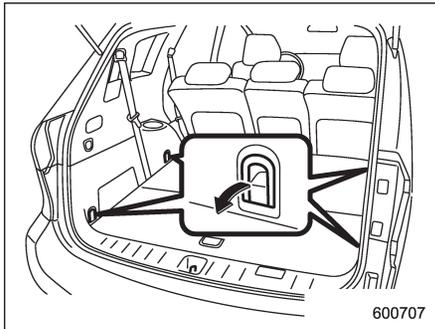

The cargo area is equipped with four tie-down hooks so that cargo can be secured with a luggage net or ropes.

When using the tie-down hooks, turn them down out of the storing recesses. When not in use, put the hooks up into the storing recesses.

Under-floor storage compartment

The subfloor storage compartment is located under the floor of the cargo area and can be used to store small items. To open the lid, pull the handle up.

CAUTION

- Always keep the lid of the sub-floor storage compartment closed while driving to reduce the risk of injury in the event of sudden stop or an accident.
- Do not store spray cans, containers with flammable or corrosive liquids or any other dangerous items in the subfloor storage compartment.

5-seater models

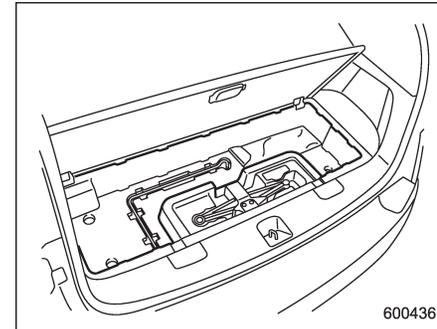
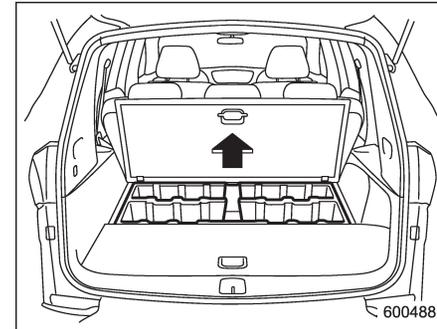

Hang the hook provided on the underside of the rear half lid on the rear edge of the roof to keep the lid open.

– CONTINUED –

■ 7-seater models

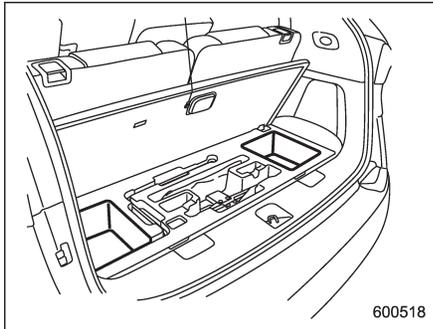

Hang the hook provided on the underside of the lid on the rear edge of the roof to keep the lid open.

HomeLink® Wireless Control System (if equipped)

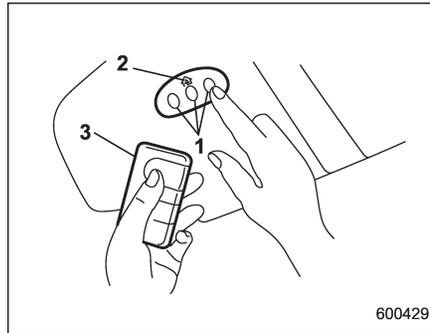

- 1) HomeLink® buttons
 - 2) Indicator light
 - 3) Hand-held transmitter*
- * Not part of your vehicle's remote keyless entry system but of a HomeLink®-compatible device.

The HomeLink® Wireless Control System, located on the driver's sun visor, is a handy way to operate, from inside of your vehicle, up to three remote-controlled indoor and outdoor devices, such as garage door openers, entrance gates, door locks, home lighting, and security systems. There are three HomeLink® buttons on the sun visor, each of which you can program for operation of one

desired device. For details on the device types which can be operated by this system, consult the HomeLink website at www.homelink.com or call 1-800-355-3515.

Note the following about this system:

If your vehicle is equipped with the HomeLink® Wireless Control System, it complies with Part 15 of the Federal Communication Commission Rules in the U.S. and the RSS-210 of Industry Canada in Canada. Its operation is subject to the following two conditions:

(1) this device may not cause harmful interference, and (2) this device must accept any interference received, including interference that may cause undesired operation.

Changes and modifications to this system by anyone other than an authorized service facility could void authorization to use this equipment.

HomeLink and the HomeLink house are registered trademarks of Johnson Controls, Inc.

WARNING

- When programming the HomeLink® Wireless Control System, you may be operating a

garage door opener or other device. Make sure that people and objects are out of the way of the garage door opener or other device to prevent potential harm or damage.

- Do not use the HomeLink® Wireless Control System with any garage door opener that lacks the safety stop and reverse feature as required by applicable safety standards. A garage door opener which cannot detect an object, signaling the door to stop and reverse, does not meet these safety standards. Using a garage door opener without these features increases risk of serious injury or death. For more information, consult the HomeLink website at www.homelink.com or call 1-800-355-3515.



CAUTION

When programming the HomeLink® Wireless Control System to operate a garage door opener or an entrance gate, unplug the device's motor from the outlet during programming to prevent motor burnout.

NOTE

- After programming your HomeLink® Wireless Control System for the desired devices, retain the hand-held transmitters for further programming or device testing in the event of a problem.
- It is recommended that you insert a new battery in the hand-held transmitter of a device to ensure correct programming.

■ Garage door opener programming in the U.S.A.

NOTE

When programming the HomeLink® Wireless Control System for a garage door opener, it is suggested that you park the vehicle outside the garage.

1. Unplug the motor of the garage door opener from the outlet.

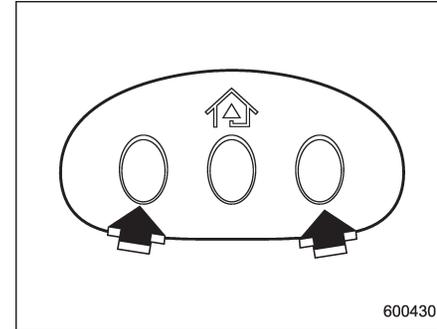

2. Press and hold the two outside HomeLink® buttons until the indicator light begins to flash (after 20 seconds). Release both buttons.

NOTE

If any of the HomeLink® buttons are already programmed for other devices, skip step 2 because it clears the memory of all the three buttons.

3. Hold the end of the garage door opener's hand-held transmitter between 1 and 3 inches (25 and 76 mm) away from the HomeLink® buttons on the driver's sun visor, keeping the indicator light in view.

– CONTINUED –

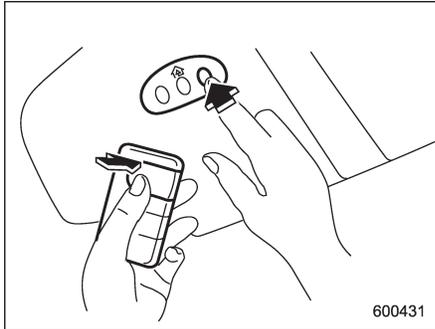

4. Using both hands, simultaneously push the hand-held transmitter button and the desired HomeLink® button. DO NOT release the buttons until step 5 has been completed.

5. Hold down both buttons until the HomeLink® indicator light flashes, first slowly then rapidly. When the indicator light flashes rapidly, both buttons may be released. (The rapidly flashing light indicates successful programming of the new frequency signal.)

6. Press and hold the programmed button and check the HomeLink® indicator light. If the indicator light stays on continuously, your garage door should activate and the programming is completed.

If the indicator light flashes rapidly for 2 seconds and then stays on continuously,

your garage door opener may be protected by a rolling code feature. In this case you need to perform the additional steps for “Programming rolling-code-protected garage door openers in the U.S.A.” described in the following.

NOTE

Rolling-code-protected garage door openers are manufactured after 1996. See the instruction manual of your garage opener for confirmation.

7. Reconnect the motor of your garage door opener to the outlet.

8. Test your garage door opener by pressing the programmed HomeLink® button.

■ Programming rolling-code-protected garage door openers in the U.S.A.

If your garage door opener has a rolling code feature, program the HomeLink® Wireless Control System for it by following steps 1 through 5 in the “Garage door opener programming in the U.S.A.” section above and then continuing with the steps below.

NOTE

The assistance of a second person

may make the programming quicker and easier.

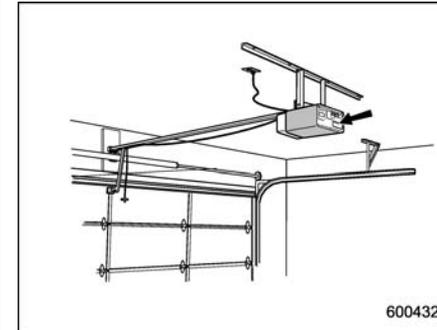

1. Locate the training button on the garage door opener motor head unit. The exact location and color of the button may vary by brand of garage door opener. If it is difficult to locate the training button, refer to your garage door opener’s instruction manual.

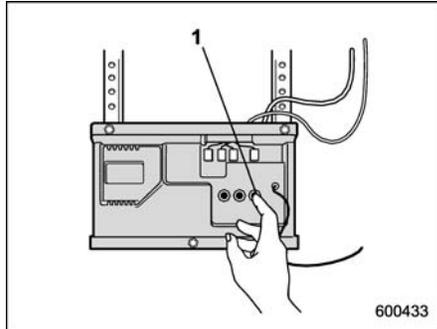

1) Training button

2. Press the training button on the garage door opener motor head unit (which activates the "training light" on the unit). Proceed to step 3 within 30 seconds.
3. Inside the vehicle, firmly press and release the HomeLink® button that was programmed in the section above. Press and release the button a second time to complete the programming procedure.

NOTE

Some garage door openers may require you to do the above procedure a third time to complete the programming.

4. The garage door opener should now recognize the HomeLink® Wireless Con-

trol System and your garage door opener should activate when the HomeLink® button is pressed.

■ Programming for entrance gates and garage door openers in Canada

1. Unplug the motor of the entrance gate or garage door opener from the outlet.

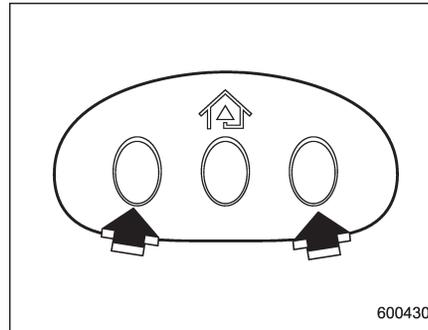

2. Press and hold the two outside buttons until the HomeLink® indicator light begins to flash (after 20 seconds). Release both buttons.

NOTE

If any of the HomeLink® buttons are already programmed for other devices, skip step 2 because it clears the

memory of all three buttons.

3. Hold the end of the entrance gate's/garage door opener's hand-held transmitter between 1 and 3 inches (25 and 76 mm) away from the HomeLink® buttons on the driver's sun visor, keeping the indicator light in view.

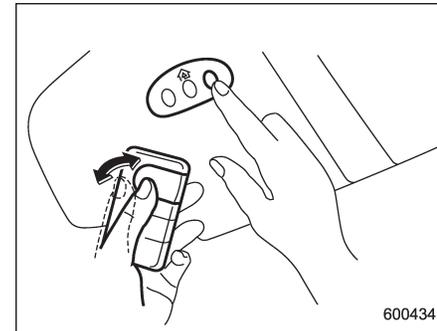

4. Press and hold the desired HomeLink® button.
5. Press and release ("cycle") the hand-held transmitter button every 2 seconds until step 6 is complete.
6. When the indicator light flashes slowly and then rapidly after several seconds, release both buttons.
7. Plug the motor of the entrance gate/garage door opener to the outlet.
8. Test your entrance gate/garage door

– CONTINUED –

opener by pressing the programmed HomeLink® button.

■ Programming other devices

To program other devices such as door locks, home lighting and security systems, contact HomeLink at www.homelink.com or call 1-800-355-3515.

■ Operating the HomeLink® Wireless Control System

Once programmed, the HomeLink® Wireless Control System can be used to remote-control the devices to which its buttons are programmed. To activate a device, simply press the appropriate button. The indicator light illuminates, indicating that the signal is being transmitted.

■ Reprogramming a single HomeLink® button

1. Press and hold the HomeLink® button you wish to reprogram. DO NOT release the button until step 4 has been completed.
2. When the HomeLink® indicator light begins to flash slowly (after 20 seconds), position the hand-held transmitter of the device for which you wish to program the button at 1 to 3 inches (25 to 76 mm) away from the HomeLink® button surface.

3. Press and hold the hand-held transmitter button. The HomeLink® indicator light will flash, first slowly and then rapidly.
4. When the indicator light begins to flash rapidly, release both buttons.

The programming for the previous device is now erased and the new device can be operated by pushing the HomeLink® button.

■ Erasing HomeLink® button memory

NOTE

- Performing this procedure erases the memory of all the preprogrammed buttons simultaneously. The memory of individual buttons cannot be erased.
- It is recommended that upon the sale of the vehicle, the memory of all programmed HomeLink® buttons be erased for security purposes.

1. Press and hold the two outside buttons until the indicator light begins to flash (after 20 seconds).
2. Release both buttons.

■ In case a problem occurs

If you cannot activate a device using the corresponding HomeLink® button after programming, contact HomeLink at www.homelink.com or call 1-800-355-3515 for assistance.

Rear view camera (if equipped)

When the ignition switch is "ON" and the selector lever is set to "R", the rear view camera automatically displays the rear view image from the vehicle.

WARNING

- Since the rear view camera uses a wide-angle lens, the image on the monitor is different from the actual view in terms of distance.
- Since the range of the image on the monitor is limited, you should always check the rear view with your eyes and move backward at a slow speed.
- Do not disassemble or modify the camera, switch or wiring. If smoke comes out or you smell a strange odor, stop using the rear view camera immediately. Contact your SUBARU dealer for an inspection. Continued use may result in accident, fire or electric shock.

CAUTION

- If your vehicle is washed with a high-pressure washer, do not allow water to contact the camera directly. Entry of water in the camera lens may result in condensation, malfunction, fire or electric shock.
- Since the camera is a precision device, do not subject it to strong impacts. Otherwise, malfunction, fire or electric shock may occur.
- If mud or snow sticks to or is frozen on the camera, you must be very careful removing it. Otherwise, damage done to the camera may cause a fire or electric shock. Pour lukewarm water over the camera to remove mud or ice.
- Do not put a flame close to the camera or wiring. Otherwise, damage or fire may occur.
- When replacing the fuse, be sure to use a fuse with the specified rating. Use of a fuse with a different rating may result in a malfunction.
- If the rear view camera is used for a long time while the engine is

not operated, the battery may become completely discharged.

NOTE

- Do not wipe the camera with alcohol, benzine or paint thinner. Otherwise, discoloration may occur. To remove contamination, wipe the camera with a cloth moistened with a diluted neutral detergent and then wipe it with a dry cloth.
- When waxing the vehicle, be careful not to apply the wax to the camera. If it comes in contact with the camera, moisten a clean cloth with a diluted neutral detergent to remove the wax.
- The camera lens has hard coating to help prevent scratches. However, when washing the vehicle or cleaning the camera lens, be careful not to scratch the camera lens. Do not use a washing brush directly on the camera lens. The monitor screen may be adversely affected.
- Strong light shined on the camera lens may develop white light stripes around the light source. This is not a malfunction.

– CONTINUED –

■ Position of rear view camera

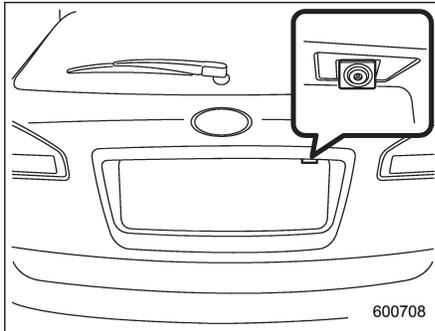

It is attached to the rear gate.

■ How to use the rear view camera

▼ To display the rear view camera image

When the selector lever is set to "R", the rear view camera automatically displays the rear view image from the vehicle. When the lever is set to other positions, the image before setting to "R" is displayed.

1. Set the ignition switch to "ON".
2. Set the selector lever to "R".

NOTE

- The image of the rear view camera has priority over other screen displays.
- The image of the rear view camera is horizontally reversed as is the case with the vehicle rearview mirror or the side view mirror.
- If the lens of the camera is dirty, it is difficult to see the image. Carefully remove the raindrops, snow and dirt if they are attached.
- It is difficult to see the image of the rearview mirror in the following cases. This is not a malfunction of the camera.
 - The image may become poor when the vehicle is in a dark place (at night, in a tunnel, etc.) or an extremely hot or cold place. This is not a malfunction.
 - Strong light shined directly on the camera lens may develop white light stripes on the image. This is not a malfunction.
- While the rear view camera is in operation, the operations of other screens are disabled. To operate other screens, set the selector lever to a position other than "R". (vehicles with a genuine SUBARU navigation system)

■ Viewing range on the screen

▼ Viewing range on the screen

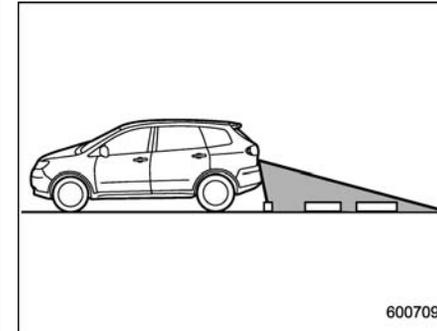

Range of view

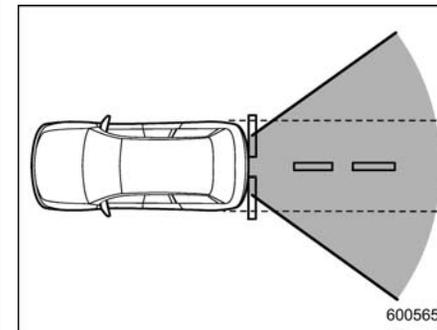

Range of view

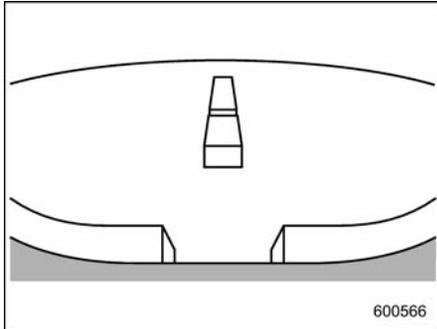
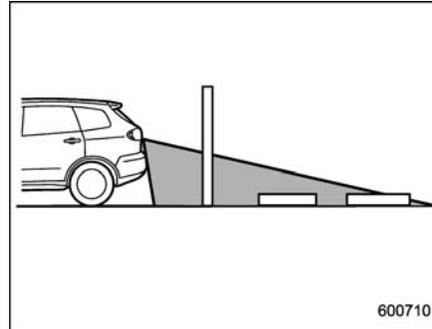

Image from camera

The area from the rear end of the bumper can be viewed. Areas at both ends of the bumper cannot be viewed.

CAUTION

The range that can be viewed with the rear view camera is limited. Always be sure to check with your eyes when moving backward and proceed slowly.



Range of view

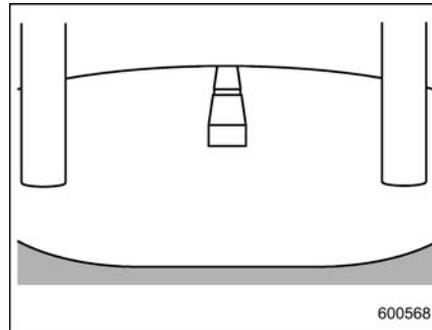

Image from camera

The area above the camera cannot be viewed. If there is a protrusion on a block, it cannot be seen on the screen.

CAUTION

The range that can be viewed with the rear view camera is limited. Always be sure to check with your eyes when moving backward and proceed slowly.

▼ Screen view and actual distance

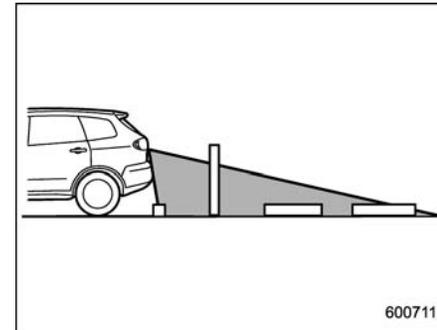

Range of view

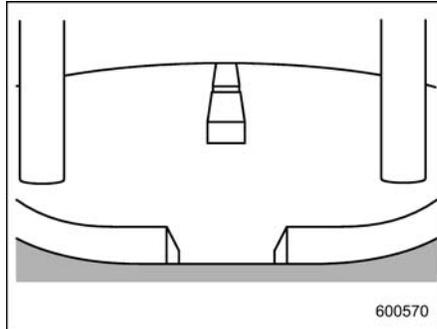
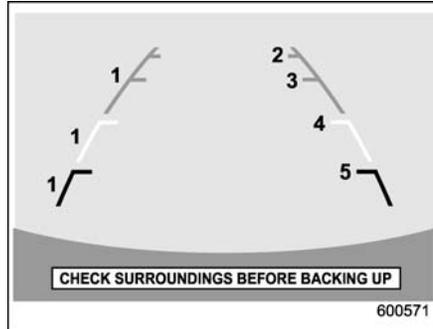

Image from camera

The image from the rear view camera looks shorter than the actual distance.

Distance marker (help line)

The distance marker (help line) is a guide to help you realize the actual distance from the screen.



- 1) Vehicle width line (oblique vertical line)
- 2) Approx. 10 feet (3 m) from the bumper (green horizontal line)
- 3) Approx. 6.5 feet (2 m) from the bumper (green horizontal line)
- 4) Approx. 3 feet (1 m) from the bumper (yellow horizontal line)
- 5) Approx. 1.5 feet (0.5 m) from the bumper (red horizontal line)

When the selector lever is set to position "R", the monitor screen displays the distance markers together with the rear view image.

CAUTION

- When moving backward, always check the back with your eyes without relying on the distance markers.

- The actual position may be different from the indication of the distance markers.
- Differences may occur due to number of passengers or loaded cargo.
- When the vehicle is on a slope or when the vehicle is inclined against the road, the indication is different from the actual position.

NOTE

Approximately 2.6 feet (0.8 m) is needed to open and close the rear gate.

▼ Difference between screen and actual road

The distance markers show the distance for a level road when the vehicle is not loaded. It may be different from the actual distance depending on the loading conditions or road conditions.

▽ When there is an upward slope at the back

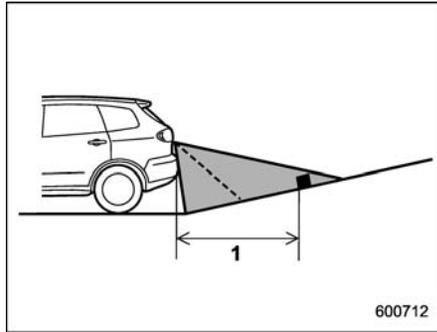

- 1) 3 feet (1 m)

The distance on the screen looks farther than the actual distance.

▽ When there is a downward slope at the back

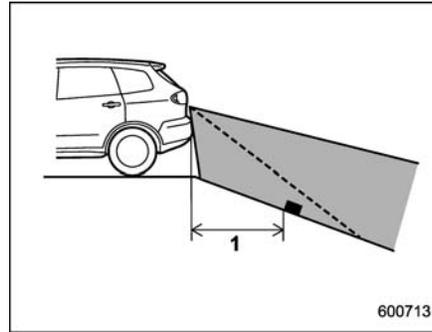

- 1) 3 feet (1 m)

The distance on the screen looks nearer than the actual distance.

NOTE

When cargo is loaded, the rear view distance on the screen looks farther than the actual distance as in an upward slope.

▼ Feature of distance marker

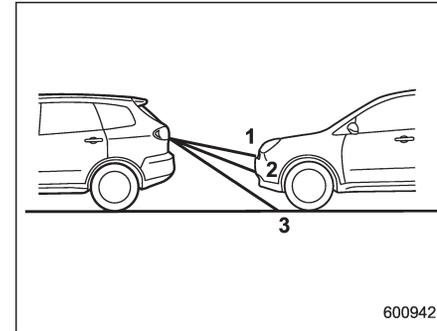

- 1) 10 feet (3 m) line
- 2) 6.5 feet (2 m) line
- 3) 3 feet (1 m) line

The distance marker shows the distance on the road. If there is a car or other object close behind, distance cannot be correctly displayed.

Starting and operating

Fuel	7-2	Shift lock release	7-17
Fuel requirements	7-2	Power steering	7-18
Fuel filler lid and cap	7-3	Braking	7-18
State emission testing (U.S. only)	7-5	Braking tips	7-18
Preparing to drive	7-7	Brake system	7-19
Starting the engine	7-7	Disc brake pad wear warning indicators	7-19
Stopping the engine	7-8	ABS (Anti-lock Brake System)	7-20
Remote engine start system (dealer option)	7-8	ABS system self-check	7-20
Starting your vehicle	7-9	ABS warning light	7-21
Remote start safety features	7-9	Electronic Brake Force Distribution (EBD)	
Entering the vehicle while it is running via remote		system	7-22
start	7-9	Steps to take if EBD system fails	7-22
Entering the vehicle following remote engine start		Vehicle Dynamics Control system	7-23
shutdown	7-9	Vehicle Dynamics Control system monitor	7-25
Pre-heating or pre-cooling the interior of the		Traction Control system OFF switch	7-26
vehicle	7-10	Tire pressure monitoring system (TPMS)	7-27
Service mode	7-10	Parking your vehicle	7-29
Remote engine start transmitter programming		Parking brake	7-29
and programmable feature option	7-10	Parking tips	7-29
System maintenance	7-11	Cruise control	7-30
Automatic transmission	7-12	To set cruise control	7-30
Selector lever	7-13	To temporarily cancel the cruise control	7-31
Selector lever reverse inhibiting function	7-14	To turn off the cruise control	7-31
Selection of manual mode	7-15	To change the cruising speed	7-32
Maximum speeds	7-16	Cruise control indicator light	7-33
Driving tips	7-16	Cruise control set indicator light	7-33
SPORT mode	7-17		

Fuel



Use of a fuel which is low in quality or use of an inappropriate fuel additive may cause engine damage.

■ Fuel requirements

The engine is designed to operate using unleaded gasoline with an octane rating of 87 AKI or higher.

▼ Fuel octane rating

This octane rating is the average of the Research Octane and Motor Octane numbers and is commonly referred to as the Anti Knock Index (AKI).

Using a gasoline with a lower octane rating can cause persistent and heavy knocking, which can damage the engine. Do not be concerned if your vehicle sometimes knocks lightly when you drive up a hill or when you accelerate. See your dealer or a qualified service technician if you use a fuel with the specified octane rating and your vehicle knocks heavily or persistently.

▼ Unleaded gasoline

The neck of the fuel filler pipe is designed to accept only an unleaded gasoline filler nozzle. Under no circumstances should leaded gasoline be used because it will damage the emission control system and may impair driveability and fuel economy.

▼ California fuel

If your vehicle was certified to California Emission Standards as indicated on the underhood tune-up label, it is designed to optimize engine and emission control system performance with gasoline that meets the clean burning low-sulfur California gasoline specifications. If you live in any other state than California, your vehicle will operate on gasoline meeting Federal specifications. Gasoline sold outside California is permitted to have higher sulfur levels, which may affect the performance of your vehicle's catalytic converter and may produce a sulfur exhaust odor or smell. SUBARU recommends that you try a different brand of unleaded gasoline having lower sulfur to determine if the problem is fuel related before returning your vehicle to an authorized dealer for service. The CHECK ENGINE warning light/Malfunction indicator lamp may also illuminate. If this occurs, return to your authorized SUBARU dealer for diagnosis. If it is determined that the condition is

caused by the type of fuel used, repairs may not be covered by your warranty.

▼ MMT

Some gasoline contains an octane-enhancing additive called MMT (Methylcyclopentadienyl Manganese Tricarbonyl). If you use such fuels, your emission control system performance may deteriorate and the CHECK ENGINE warning light/Malfunction indicator lamp may illuminate. If this happens, return to your authorized SUBARU dealer for service. If it is determined that the condition is caused by the type of fuel used, repairs may not be covered by your warranty.

▼ Gasoline for cleaner air



Do not let fuel spill on the exterior surfaces of the vehicle. Fuels containing alcohol may cause paint damage, which is not covered under the SUBARU Limited Warranty.

Your use of gasoline with detergent additives will help prevent deposits from forming in your engine and fuel system. This helps keep your engine in tune and your emission control system working properly, and is a way of doing your part for cleaner air. If you continuously use a

high quality fuel with the proper detergent and other additives, you should never need to add any fuel system cleaning agents to your fuel tank.

Many gasolines are now blended with materials called oxygenates. Use of these fuels can also help keep the air cleaner. Oxygenated blend fuels, such as MTBE (Methyl Tertiary Butyl ether) or ethanol (ethyl or grain alcohol) may be used in your vehicle, but should contain no more than 15% MTBE or 10% ethanol for the proper operation of your SUBARU.

In addition, some gasoline suppliers are now producing reformulated gasolines, which are designed to reduce vehicle emissions. SUBARU approves the use of reformulated gasoline.

If you are not sure what the fuel contains, you should ask your service station operators if their gasolines contain detergents and oxygenates and if they have been reformulated to reduce vehicle emissions.

As additional guidance, only use fuels suited for your vehicle as explained in the following.

- Fuel should be unleaded and have an octane rating no lower than that specified in this manual.

- Methanol (methyl or wood alcohol) is sometimes mixed with unleaded gasoline. Methanol can be used in your vehicle **ONLY** if it does not exceed 5% of the fuel mixture **AND** if it is accompanied by sufficient quantities of the proper cosolvents and corrosion inhibitors required to prevent damage to the fuel system. Do not use fuel containing methanol **EXCEPT** under these conditions.

- If undesirable driveability problems are experienced and you suspect they may be fuel related, try a different brand of gasoline before seeking service at your SUBARU dealer.

- Fuel system damage or driveability problems which result from the use of improper fuel are not covered under the SUBARU Limited Warranty.

■ Fuel filler lid and cap

▼ Refueling

Only one person should be involved in refueling. Do not allow others to approach the area of the vehicle near the fuel filler pipe while refueling is in progress.

Be sure to observe any other precautions that are posted at the service station.

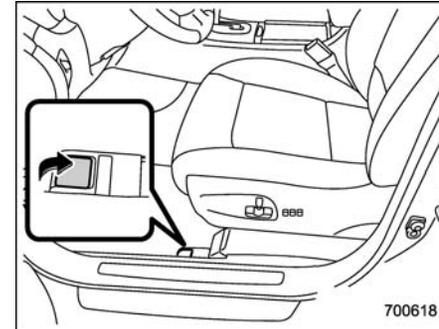

1. To open the fuel filler lid, pull the lid release lever up. The lever is on the floor at the left of the driver's seat.

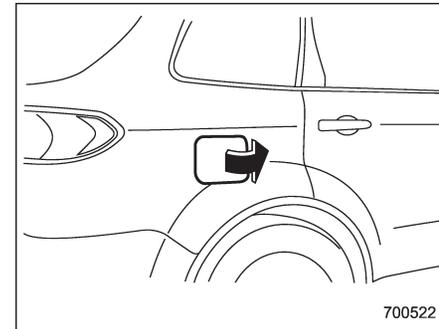

2. Open the fuel filler lid.

– CONTINUED –

7-4 Starting and operating

WARNING

Before opening the fuel filler cap, first touch the vehicle body or a metal portion of the fuel pump or similar object to discharge any static electricity that may be present on your body. If your body is carrying an electrostatic charge, there is a possibility that an electric spark could ignite the fuel, which could burn you. To avoid acquiring a new static electric charge, do not get back into the vehicle while refueling is in progress.

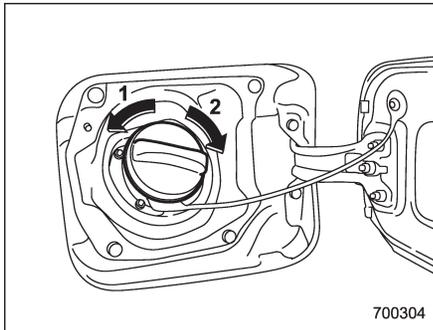

- 1) Open
- 2) Close

3. Remove the fuel filler cap by turning it slowly counterclockwise.

WARNING

- Gasoline vapor is highly flammable. Before refueling, always first stop the engine and close all vehicle doors and windows. Make sure that there are no lighted cigarettes, open flames or electrical sparks in the adjacent area. Refueling must be performed outside. Quickly wipe up any spilled fuel.
- When opening the cap, grasp it firmly and turn it slowly to the left. Do not remove the cap quickly. Fuel may be under pressure and spray out of the fuel filler neck, especially in hot weather. If you hear a hissing sound while you are removing the cap, wait for the sound to stop and then slowly open the cap to prevent fuel from spraying out and creating a fire hazard.
- When refueling, insert the fuel nozzle securely into the fuel filler pipe. If the nozzle is lifted or not fully inserted, its automatic stopping mechanism may not func-

tion, causing fuel to overflow the tank and creating a fire hazard.

- Stop refueling when the automatic stop mechanism on the fuel nozzle activates. If you continue to add fuel, temperature changes or other conditions may cause fuel to overflow from the tank and create a fire hazard.

4. Stop filling the tank after the fuel filler pump automatically turns off. Do not add any more fuel.

CAUTION

Make sure that the cap is tightened until it clicks to prevent fuel spillage in the event of an accident.

5. Put the cap back on, turn it clockwise until you hear a clicking noise. Be certain not to catch the tether under the cap while tightening.
6. Close the fuel filler lid completely. If you spill any fuel on the painted surface, rinse it off immediately. Otherwise, the painted surface could be damaged.

NOTE

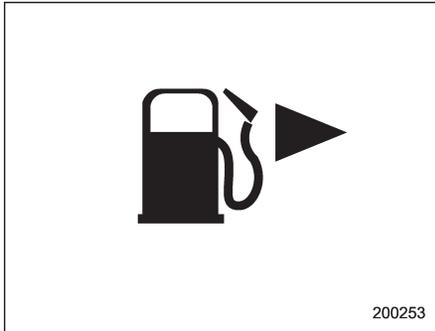

- You will see the “▶” sign in the fuel gauge. This indicates that the fuel filler door (lid) is located on the right side of the vehicle.
- If the fuel filler cap is not tightened until it clicks or if the tether is caught under the cap, the CHECK ENGINE warning light/malfunction indicator lamp may illuminate. Refer to the “Warning and indicator lights” section located in chapter 3.

 CAUTION

- Never add any cleaning agents to the fuel tank. The addition of a cleaning agent may cause da-

mage to the fuel system.

- After refueling, turn the cap to the right until it clicks to ensure that it is fully tightened. If the cap is not securely tightened, fuel may leak out while the vehicle is being driven or fuel spillage could occur in the event of an accident, creating a fire hazard.
- Do not let fuel spill on the exterior surfaces of the vehicle. Because fuel may damage the paint, be sure to wipe off any spilled fuel quickly. Paint damage caused by spilled fuel is not covered under the SUBARU Limited Warranty.
- Always use a genuine SUBARU fuel filler cap. If you use the wrong cap, it may not fit, and your fuel tank and emission control system may be damaged. It could also lead to fuel spillage and a fire.
- Immediately put fuel in the tank whenever the low fuel warning light illuminates. Engine misfires as a result of an empty tank could cause damage to the engine.

State emission testing (U.S. only)

 WARNING

Testing of an All-Wheel Drive vehicle must NEVER be performed on a single two-wheel dynamometer. Attempting to do so will result in uncontrolled vehicle movement and may cause an accident or injuries to persons nearby.

 CAUTION

Resultant vehicle damage due to improper testing is not covered under the SUBARU Limited Warranty and is the responsibility of the state inspection program or its contractors or licensees.

At state inspection time, remember to tell your inspection or service station in advance not to place your SUBARU AWD vehicle on a two-wheel dynamometer. Otherwise, serious transmission damage will result.

Some states have started using dynamometers in their state inspection programs

– CONTINUED –

7-6 Starting and operating

in order to meet their obligation under federal law to implement stricter vehicle emission standards to reduce air pollution from vehicles. A dynamometer is a treadmill or roller-like testing device that allows your vehicle's wheels to turn while the vehicle remains in one place. Depending on the severity of a state's air pollution problems, the states must adopt either a "basic" or "enhanced" vehicle emission inspection test. Normally, a portion of the basic emission test consists of an emission inspector inserting an analyzer probe into the exhaust pipe of an idling vehicle for a short period of time. States with more severe air pollution problems are required to adopt an enhanced vehicle emission test. This test simulates actual driving conditions on a dynamometer and permits more accurate measurement of tailpipe emitted pollution than the basic emission test.

The U.S. Environmental Protection Agency (EPA) and states using two-wheel dynamometers in their emission testing programs have **EXEMPTED** SUBARU AWD vehicles from the portion of the testing program that involves a two-wheel dynamometer.

There are some states that use four-wheel dynamometers in their testing programs. When properly used, that equipment will

not damage an AWD SUBARU vehicle.

Under no circumstances should the rear wheels be jacked off the ground, nor should the driveshaft be disconnected for state emission testing.

The EPA has issued regulations for inspecting the On-Board Diagnostic (OBD) system as part of the state emissions inspection. The OBD system is designed to detect engine and transmission problems that might cause vehicle emissions to exceed allowable limits. These inspections apply to all 1996 model year and newer passenger cars and light trucks. Over 30 states plus the District of Columbia have implemented the OBD system inspection.

- The inspection of the OBD system consists of a visual operational check of the "**CHECK ENGINE**" warning light/malfunction indicator lamp (MIL) and an examination of the OBD system with an electronic scan tool while the engine is running.

- A vehicle passes the OBD system inspection if proper the "**CHECK ENGINE**" warning light/MIL illumination is observed, there is **no** stored diagnostic trouble codes, and the OBD system readiness monitors are complete.

- A vehicle fails the OBD inspection if the

"**CHECK ENGINE**" warning light/MIL is not properly operating or there is one or more diagnostic trouble codes stored in vehicle's computer with the "**CHECK ENGINE**" warning light/MIL illuminated.

- A state emission inspection may reject (not pass or fail) a vehicle if the number of OBD system readiness monitors "**Not Ready**" is greater than one. Under this condition, the vehicle operator should be instructed to drive his/her vehicle for a few days to set the monitors and return for an emission re-inspection.

- Owners of rejected or failing vehicles should contact their SUBARU Dealer for service.

Preparing to drive

You should perform the following checks and adjustments every day before you start driving.

1. Check that all windows, mirrors, and lights are clean and unobstructed.
2. Check the appearance and condition of the tires. Also check tires for proper inflation.
3. Look under the vehicle for any sign of leaks.
4. Check that the hood and rear gate are fully closed.
5. Check the adjustment of the seat.
6. Check the adjustment of the inside and outside mirrors.
7. Fasten your seatbelt. Check that your passengers have fastened their seatbelts.
8. Check the operation of the warning and indicator lights when the ignition switch is turned to the "ON" position.
9. Check the gauges, indicator and warning lights after starting the engine.

NOTE

Engine oil, engine coolant, brake fluid, washer fluid and other fluid levels should be checked daily, weekly or at fuel stops.

Starting the engine

CAUTION

- **Do not operate the starter motor continuously for more than 10 seconds. If the engine fails to start after operating the starter for 5 to 10 seconds, wait for 10 seconds or more before trying again.**
- **If you restart the engine while the vehicle is moving, shift the selector lever into the "N" position. Do not attempt to place the selector lever of a moving vehicle into the "P" position.**

1. Apply the parking brake.
2. Turn off unnecessary lights and accessories.
3. Shift the selector lever to the "P" or "N" position (preferably "P" position). The starter will only operate when the selector lever is at the "P" or "N" position.
4. Turn the ignition switch to the "ON" position and check the operation of the warning and indicator lights. Refer to the "Warning and indicator lights" section in chapter 3.
5. Turn the ignition switch to the "START"

position **without** depressing the accelerator pedal. Release the key immediately after the engine has started.

If the engine does not start, try the following.

- (1) Turn the ignition switch to the "LOCK" position and wait for at least 10 seconds. After checking that the parking brake is firmly set, turn the ignition switch to the "START" position while depressing the accelerator pedal slightly (approximately a quarter of the full stroke). Release the accelerator pedal as soon as the engine starts.
 - (2) If this fails to start the engine, turn the ignition switch back to the "LOCK" position and wait for at least 10 seconds. Then fully depress the accelerator pedal and turn the ignition switch to the "START" position. If the engine starts, quickly release the accelerator pedal.
 - (3) If this fails to start the engine, turn the ignition switch again to the "LOCK" position. After waiting for 10 seconds or longer, turn the ignition switch to the "START" position without depressing the accelerator pedal.
 - (4) If the engine still refuses to start, contact your nearest SUBARU dealer for assistance.
6. Confirm that all warning and indicator

– CONTINUED –

7-8 Starting and operating

lights have turned off after the engine has started. The fuel injection system automatically lowers the idle speed as the engine warms up.

While the engine is warming up, make sure that the selector lever is at the "P" or "N" position and that the parking brake is applied.

Stopping the engine

 **WARNING**

Do not stop the engine when the vehicle is moving. This will cause loss of power to the power steering and the brake booster, making steering and braking more difficult. It could also result in accidental activation of the "LOCK" position on the ignition switch, causing the steering wheel to lock.

The ignition switch should be turned off only when the vehicle is stopped and the engine is idling.

Remote engine start system (dealer option)

 **WARNING**

- Do not start the engine using the remote start system in an enclosed environment (e.g. closed garage). Prolonged operation of a motor vehicle in an enclosed environment can cause a harmful build-up of Carbon Monoxide. Carbon Monoxide is harmful to your health. Exposure to high levels of Carbon Monoxide can cause headaches, dizziness or in extreme cases unconsciousness and/or death.
- Before performing any servicing of the vehicle, temporarily place the remote engine start system in service mode to prevent the system from unexpectedly starting the engine.

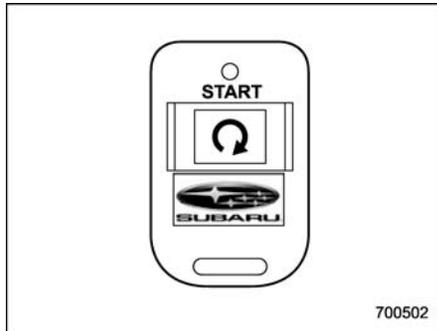

■ Starting your vehicle

The remote engine start system is activated by pressing the “” button twice within 3 seconds on your remote engine start transmitter. The system will check certain pre-conditions before starting, and if all safety parameters are correct, the engine will start within 5 seconds. While the vehicle is operating via remote engine start, the vehicle’s power window features will be disabled. Also, the system has a timer and will shut down after 15 minutes if you do not operate the vehicle. Press and hold the “” button for 2 seconds again to turn the vehicle off. If the vehicle’s starter cranks but does not start or starts and stalls, the remote engine start system will power off then attempt to start the vehicle

an additional four times. If the vehicle fails to start after the additional attempts, the remote engine start system will abort and return to a non activated state.

■ Remote start safety features

For safety and security reasons, the system will fail to start and beep the horn twice or shut down the engine during remote start operation if any of the following occur:

- The brake pedal is depressed before the vehicle ignition switch is turned “on”
- The key was already in the ignition switch
- The engine hood is opened
- The vehicle’s engine idle speed has reached a level over 3,000 RPM
- The alarm is triggered by opening a door or the rear gate.

NOTE

- **The security indicator light on the dashboard will stop flashing while under remote engine start operation, but the vehicle is still protected.**
- **If the vehicle is entered during remote engine start operation, the system will not record entry in the alarm history.**

■ Entering the vehicle while it is running via remote start

1. Unlock the vehicle doors using the remote keyless entry system. If the vehicle’s doors are unlocked manually using the key, the vehicle’s alarm system will trigger and the remote engine start system will turn off. Inserting the key into the ignition switch and turning it to the “ON” position or pressing the unlock button “” on the remote keyless entry transmitter will disarm the alarm system. Refer to the “Alarm system” section in chapter 2.
2. Enter the vehicle. Do not depress the brake pedal.
3. Insert the key into the ignition switch and turn to the “ON” position. If the ignition switch is accidentally turned to the “START” position, the system’s “starter anti-grind” feature will prevent the starter from re-cranking.
4. Depress the brake pedal. The remote starter disengages, the vehicle’s power window features are re-enabled and the vehicle will operate normally.

■ Entering the vehicle following remote engine start shutdown

An alarm trigger may occur if the vehicle is opened by the remote keyless entry

– CONTINUED –

7-10 Starting and operating

transmitter within a few seconds immediately following remote engine start shutdown.

■ Pre-heating or pre-cooling the interior of the vehicle

Before exiting the vehicle, set the temperature controls to the desired setting and operation. After the system starts the vehicle, the heater or air-conditioning will activate and heat or cool the interior to your setting.

■ Service mode

In service mode, the remote start function is temporarily disabled to prevent the system from unexpectedly starting the engine while being serviced.

▼ To engage the service mode

Turn the ignition switch to the "ON" position, depress and hold the brake pedal then, press and release the "Q" button on the remote engine start transmitter three times. The system will pause for 1 second and then flash the parking lights and honk the horn three times indicating that the system is in service mode. When attempting to activate the remote start system while in service mode, the parking lights will flash and the horn will honk two times and will not start.

▼ To disengage the service mode

Turn the ignition switch to the "ON" position, depress and hold the brake pedal, then press and release the "Q" button on the remote engine start transmitter three times. The system will pause for 1 second and flash the parking lights one time indicating that the system has exited service mode.

NOTE

When taking your vehicle in for service, it is recommended that you inform the service personnel that your vehicle is equipped with a remote engine start system.

■ Remote engine start transmitter programming and programmable feature option

New transmitters can be programmed to the remote engine start system in the event that remote engine start transmitters are lost, stolen or damaged. The remote engine start system also has one programmable feature that can be adjusted for user preference.

The remote engine start system can be programmed to either make an audible horn chirp upon remote start activation or not. Remote engine start transmitter programming and feature programming can

be adjusted using the following procedure.

1. Open the driver's door (the driver's door must remain opened throughout the entire process).
2. Insert the key into the vehicle's ignition switch and turn to the "ON" position.
3. Locate the small black programming button behind the fuse box cover, on the driver's side left under the dashboard panel.
4. Press and hold the black programming button for 10 to 15 seconds. The horn will honk and the parking lights will flash three times to indicate that the system has entered programming mode. At this point you can perform either action (step 5 or step 6).
5. To program a remote transmitter: press and release the "Q" button on each transmitter. The horn will honk and the parking lights will flash one time to indicate a successful transmitter learn each time the "Q" button is pressed. You can program up to eight transmitters.
6. To toggle the Horn Confirmation chirps ON/OFF: press and release the brake to toggle the feature. The horn will chirp and the parking lights will flash one time to indicate Confirmation Horn Chirps are "OFF". The horn will honk and the parking lights will flash 2 times to indicate Confirmation Horn Chirps are "ON". Depres-

sing the brake pedal repeatedly will toggle the feature ON or OFF each time.

7. To exit the remote transmitter and feature programming mode, turn the ignition switch to the "LOCK" position, remove the key from the ignition switch and test operation of the remote transmitter(s) and horn confirmation feature.

■ System maintenance

▼ Changing the batteries

The two 3-volt lithium batteries (model CR-1220) supplied in your remote engine start transmitter should last approximately three years, depending on usage. When the batteries begin to weaken, you will notice a decrease in range (distance from the vehicle that your remote engine start system operates). Follow the instructions below to change the remote control batteries.

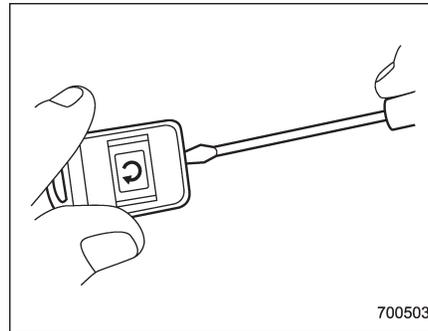

700503

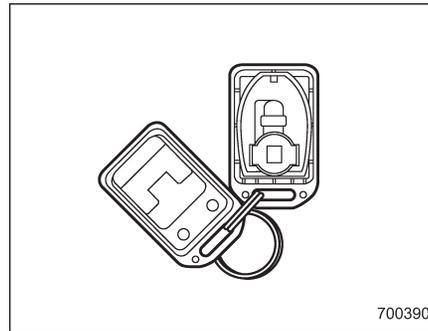

700390

1. Carefully pry the remote engine start transmitter halves apart using a small flat-head screwdriver.

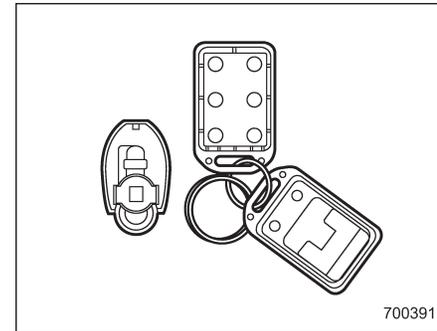

700391

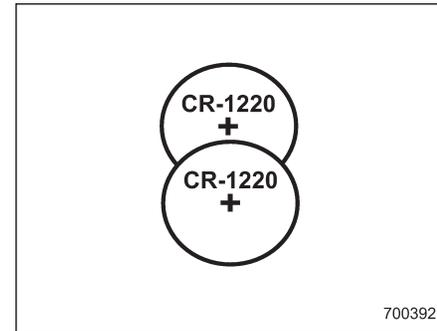

700392

2. Remove the circuit board from the bottom half of the case and slide the white plastic battery holder out from under the battery tab releasing the batteries. Remove the old batteries and replace with new ones. Be sure to observe the (+) sign

– CONTINUED –

7-12 Starting and operating

on the old batteries before removing them to ensure that the new batteries are inserted properly (battery “+” should be pointed away from the transmitter circuit board on both batteries).

3. Carefully snap the case halves back together, then test the remote engine start system.

NOTE

This device complies with Part 15 of the FCC Rules and with RSS-210 of Industry Canada. Operation is subject to the following two conditions: (1) This device may not cause harmful interference, and (2) this device must accept any interference received, including interference that may cause undesired operation.

Changes or modifications not expressly approved by the party responsible for compliance could void the user’s authority to operate the equipment.

Automatic transmission

The automatic transmission is electronically controlled and provides 5 forward speeds and 1 reverse speed. Also, it has a manual mode and a SPORT mode.



WARNING

Do not shift from the “P” or “N” position into the “D” or “R” position while depressing the accelerator pedal. This may cause the vehicle to jump forward or backward.



CAUTION

- Shift into the “P” or “R” position only after the vehicle is completely stopped. Shifting while the vehicle is moving may cause damage to the transmission.
- Do not race the engine for more than 5 seconds in any position except the “N” or “P” position when the brake is set or when chocks are used in the wheels. This may cause the automatic transmission fluid to overheat.
- Avoid shifting from one of the forward driving positions into the

“R” position or vice versa until the vehicle has completely stopped. Such shifting may cause damage to the transmission.

- When parking the vehicle, first securely apply the parking brake and then place the selector lever in the “P” position. Avoid parking for a long time with the selector lever in any other position as doing so could result in a dead battery.

NOTE

- When the engine coolant temperature is still low, your vehicle’s automatic transmission will up-shift at higher engine speeds than when the coolant temperature is sufficiently high in order to shorten the warm-up time and improve driveability. The gearshift timing will automatically shift to the normal timing after the engine has warmed up.
- Immediately after ATF (automatic transmission fluid) is replaced, you may feel that the automatic transmission operation is somewhat unusual. This results from invalidation of data which the on-board computer has

collected and stored in memory to allow the transmission to shift at the most appropriate times for the current condition of your vehicle. Optimized shifting will be restored as the vehicle continues to be driven for a while.

■ Selector lever

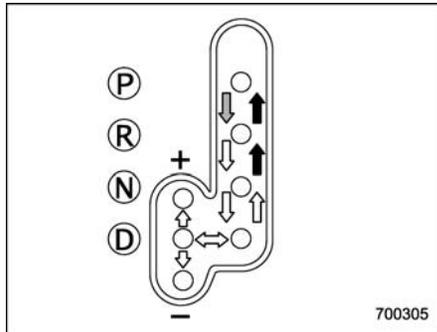

- ➡ : With the brake pedal depressed, shift while pressing the button in.
- ➡ : Shift while pressing the button in.
- ➡ : Shift without pressing the button.

The selector lever has four positions, “P”, “R”, “N”, “D” and also has manual gate for using “SPORT” mode or manual mode.

▼ P (Park)

This position is for parking the vehicle and starting the engine.

In this position, the transmission is mechanically locked to prevent the vehicle from rolling freely.

When you park the vehicle, first set the parking brake fully, then shift into the “P” position. Do not hold the vehicle with only the transmission.

To shift the selector lever from the “P” to any other position, you have to depress the brake pedal fully then push the release button on the selector lever when the ignition switch is in the “ON” position. This prevents the vehicle from lurching when it is started.

If the selector lever does not move from the “P” position with the brake pedal depressed, the release button pushed in, and the ignition switch in the ON position, refer to the “Shift lock release” section in this chapter.

NOTE

To protect the engine while the “P” position is selected, the engine is controlled such that the engine speed may not become too high even if the accelerator pedal is depressed hard.

▼ R (Reverse)

This position is for backing the vehicle.

To shift from the “N” to “R” position, stop the vehicle completely then move the lever to the “R” position while pushing the release button.

▼ N (Neutral)

This position is for restarting a stalled engine.

In this position the wheels and transmission are not locked. In this position, the transmission is neutral; the vehicle will roll freely, even on the slightest incline unless the parking brake or foot brake is applied. Avoid coasting with the transmission neutral.

During coasting, there is no engine braking effect.

NOTE

- **To protect the engine while the “N” position is selected, the engine is controlled such that the engine speed may not become too high even if the accelerator pedal is depressed hard.**
- **When the ignition switch has been turned to the “LOCK” position, movement of the selector lever from the “N” position to the “R” position is possible for a limited time period by depressing the brake pedal and then becomes impossible. If the selector lever becomes impossible to be moved after a limited time period, turn the ignition**

– CONTINUED –

7-14 Starting and operating

switch to the “ON” position. You will then be able to move the selector lever to the “P” position.

WARNING

Do not drive the vehicle with the selector lever in the “N” (Neutral) position. Engine braking has no effect in this condition and the risk of an accident is consequently increased.

▼ D (Drive)

This position is for normal driving.

The transmission automatically shifts into a suitable gear from 1st to 5th according to the vehicle speed and the acceleration you require.

When more acceleration is required in this position, depress the accelerator pedal fully to the floor and hold that position. The transmission will automatically downshift to 4th, 3rd, 2nd or 1st gear. When you release the pedal, the transmission will return to the original gear position.

To use the SPORT mode, move the lever from this position into the manual gate.

To use the manual mode, move the lever from this position into the manual gate then move it toward the “+” and “-” ends.

▽ While climbing a grade

When driving up a hill, undesired upshift to 4th or 5th gear is prevented from taking place when the accelerator is released. This minimizes the chance of subsequent downshifting to a lower gear when accelerating again. This prevents repeated upshifting and downshifting resulting in a smoother operation of the vehicle.

NOTE

The transmission may downshift to 2nd or 1st gear, depending on the way the accelerator pedal is depressed to accelerate the vehicle again.

■ Selector lever reverse inhibiting function

This function prevents accidental movement of the selector lever to the “R” position while the vehicle is moving.

The function becomes operational when the vehicle reaches a speed of approximately 6 mph (10 km/h). Once operational, it prevents the selector lever from being moved from the “N” position to the “R” position. When the vehicle speed drops below 6 mph (10 km/h), the function is canceled. The selector lever can then be moved to the “R” and “P” positions.

When the ignition switch has been turned

to the “LOCK” position, movement of the selector lever from the “N” position to the “R” position is possible for a limited time period by depressing the brake pedal and then becomes impossible. Also, the selector lever cannot be moved to the “R” position after it has been placed in the “P” position and then placed again in the “N” position.

When the movement of the selector lever from the “N” position to the “R” position has become impossible, turn the ignition switch back to the “ON” position then move the selector lever to the “P” position. Pressing the selector lever release button also makes it possible to move the selector lever to the “P” position at this time.

▼ Selector lever release button

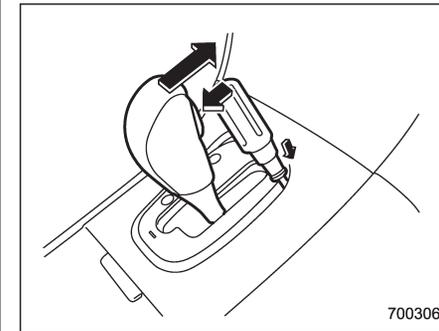

If you inadvertently have turned the ignition switch to the "LOCK" position with the selector lever in the "N" position, proceed as follows. By referring to the "Shift lock release" section in this chapter, remove the cover. Then, with a screwdriver inserted into the hole, move the selector lever to the "P" position while pressing the release button. If the selector lever reverse inhibiting function fails, have the vehicle inspected by the nearest SUBARU dealer.

■ Selection of manual mode

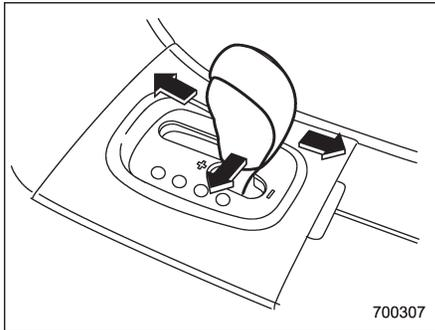

With the vehicle either moving or stationary, move the selector lever from the "D" position to the manual gate then move it to the "+" end or "-" end of the manual gate to select manual mode.

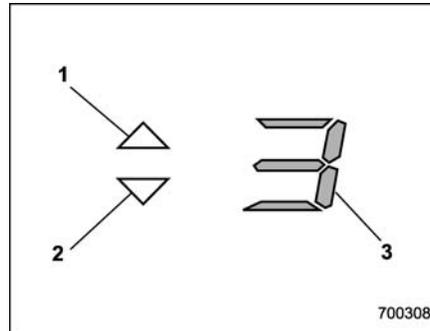

- 1) Upshift indicator
- 2) Downshift indicator
- 3) Gear position indicator

When the manual mode is selected, the gear position indicator and upshift indicator and/or downshift indicator in the tachometer illuminate. The gear position indicator shows the currently selected gear in the 1st-to-5th-gear range. The upshift and downshift indicators show when a gearshift is possible. When the upshift indicator " \triangle " is illuminated, upshifting is possible. When the downshift indicator " ∇ " is illuminated, downshifting is possible. When both indicators are illuminated, upshifting and downshifting are both possible. When the vehicle stops (for example, at traffic signals), the downshift indicator turns off.

Gearshifts can be performed using the selector lever.

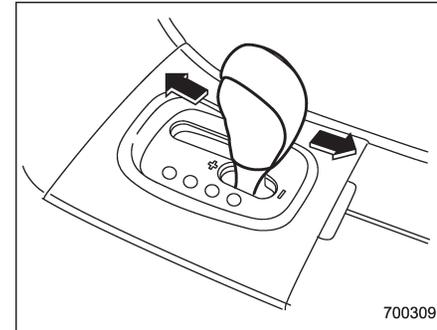

Shift to the next-higher gear by briefly pushing the selector lever toward the "+" end of the manual gate.

Shift to the next-lower gear by briefly pulling the selector lever toward the "-" end of the manual gate.

NOTE

Please read the following points carefully and bear them in mind when using the manual mode.

- When the temperature of the engine oil is higher than normal, warning beeps are emitted and the shift position indicator shows "-". If these warnings are issued, deselect the manual mode to protect the engine from damage.

- CONTINUED -

- The transmission does not automatically shift up in the manual mode. Perform gearshifts in accordance with road conditions so that the tachometer needle does not enter the red zone. If the engine speed reaches a predetermined level, a fuel-cut function will operate. Shift up if this happens. Also, the transmission may automatically shift up to protect the engine.
- If you attempt to shift down when the engine speed is too high, i.e., when a downshift would push the tachometer needle beyond the red zone, beeps will be emitted to warn you that the downshift is not possible.
- If you attempt to shift up when the vehicle speed is too low, the transmission will not respond.
- You can perform a skip-shift (for example, from 4th to 2nd) by operating the selector lever twice in rapid succession.
- The transmission automatically selects 1st gear when the vehicle stops moving.
- If the temperature of the automatic transmission fluid becomes too high, the “AT OIL TEMP” warning light will illuminate and upshifts to 5th gear will not be possible. Immediately stop the vehicle in a safe place and let the engine idle until the warning light turns

off.

■ Maximum speeds



WARNING

When down shifting, ensure that the vehicle is not travelling at a speed exceeding the Maximum Allowable Speed for the gear which is about to be selected. Failure to observe this precaution can lead to engine over-revving and this in turn can result in engine damage.

In addition, sudden application of engine braking caused by down shifting when the vehicle is travelling on a slippery surface can lead to wheel locking; as a consequence, control of the vehicle may be lost and the risk of an accident increased.

The following tables show the maximum speeds that are possible with each different gear.

When down shifting, it is important to confirm that the current vehicle speed is not in excess of the Maximum Allowable Speed of the gear which is about to be selected.

Position	mph (km/h)
1	28 (45)
2	53 (85)
3	87 (140)

Never exceed posted speed limits.

NOTE

- In order to prevent over-revving during acceleration of the vehicle, the transmission will automatically shift to the next highest gear if the Maximum Allowable Speed for the current gear is exceeded.
- Similarly, in order to prevent over-revving during deceleration of the vehicle, the transmission will remain in the current gear if the speed of the vehicle is in excess of the Maximum Allowable Speed for the gear to which the selector lever has been moved.

■ Driving tips

- On a road surface where there is a risk of wheelspin (for example, a snow- or gravel-covered road), you can pull away from a standstill safely and easily by first selecting the 2nd gear of the manual mode.
- Always apply the foot or parking brake when the vehicle is stopped in the “D” or

“R” position.

- Always set the parking brake when parking your vehicle. Do not hold the vehicle with only the transmission.
- Do not keep the vehicle in a stationary position on an uphill grade by using the “D” position. Use the brake instead.
- The engine may, on rare occasions, knock when the vehicle rapidly accelerates or rapidly pulls away from a standstill. This phenomenon does not indicate a problem.
- A slight reduction in output torque may occur before the engine warms up.

■ SPORT mode

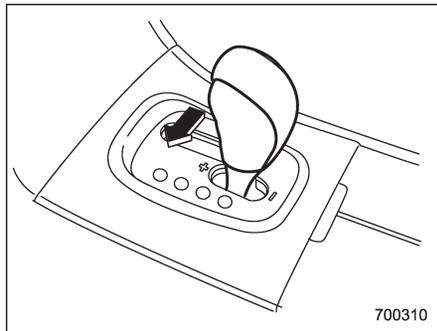

SPORT mode is used when power is needed for rapid acceleration or for uphill

driving. To select this mode, move the selector lever from the “D” position to the manual gate.

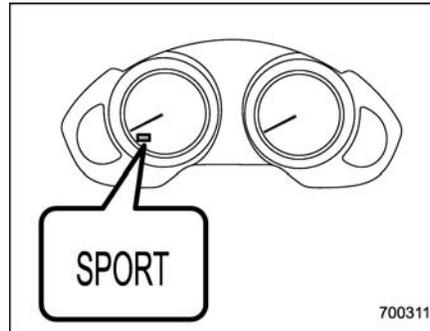

When selected, the SPORT mode indicator light on the combination meter will illuminate.

To deselect SPORT mode, move the selector lever to the “D” position or select manual mode. To subsequently reselect SPORT mode, move the selector lever to the “D” position and from there to the manual gate.

In this mode, the transmission shifts up at higher vehicle speeds and shifts down more responsively than in normal mode.

■ Shift lock release

Perform the following steps if the selector lever does not move from the “P” position

even with the release button pressed, the brake pedal depressed and the ignition switch in the “ON” position:

To override the shift lock:

1. Set the parking brake and stop the engine.
2. Take out the screwdriver from the tool bag.

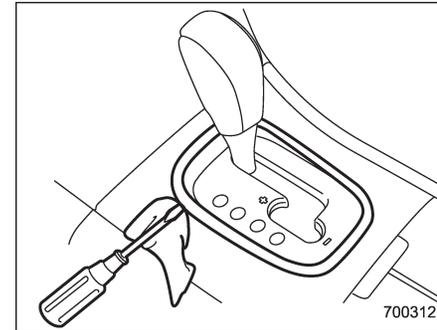

3. Remove the cover by prying on the edge with a flat-head screwdriver.

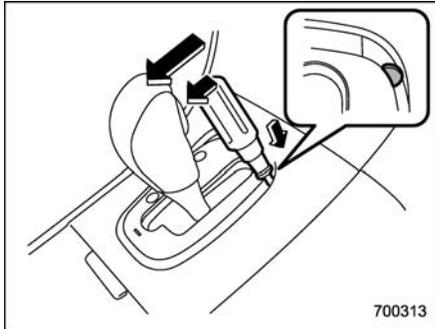

4. Insert a screwdriver into the hole.
5. Push down on the screwdriver and move the selector lever from the "P" to the "N" position while pressing the release button.
6. Remove the screwdriver from the hole. Depress the brake pedal and start the engine.

Take your vehicle to the nearest SUBARU dealer immediately to have the system repaired.

Power steering

CAUTION

Do not hold the steering wheel at the fully locked position left or right for more than 5 seconds. This may damage the power steering pump.

The power steering system operates only when the engine is running.

If you lose power steering assist because the engine stops or the system fails to function, you can steer but it will take much more effort.

NOTE

Right after the engine has been started and before it has warmed up, you may hear a noise coming from areas adjacent to the power steering pump which is located at the right-front area of the engine compartment. This noise is normal. It does not indicate power steering system trouble.

Braking

Braking tips

WARNING

Never rest your foot on the brake pedal while driving. This can cause dangerous overheating of the brakes and needless wear on the brake pads and linings.

▼ When the brakes get wet

When driving in rain or after washing the vehicle, the brakes may get wet. As a result, brake stopping distance will be longer. To dry the brakes, drive the vehicle at a safe speed while lightly depressing the brake pedal to heat up the brakes.

▼ Use of engine braking

Remember to make use of engine braking in addition to foot braking. When descending a grade, if only the foot brake is used, the brakes may start working improperly because of brake fluid overheating, caused by overheated brake pads. To help prevent this, shift into a lower gear to get stronger engine braking.

▼ Braking when a tire is punctured

Do not depress the brake pedal suddenly when a tire is punctured. This could cause

a loss of control of the vehicle. Keep driving straight ahead while gradually reducing speed. Then slowly pull off the road to a safe place.

■ Brake system

▼ Two separate circuits

Your vehicle has a dual circuit brake system. Each circuit works diagonally across the vehicle. If one circuit of the brake system should fail, the other half of the system still works. If one circuit fails, the brake pedal will go down much closer to the floor than usual and you will need to depress it down much harder. And a much longer distance will be needed to stop the vehicle.

▼ Brake booster

The brake booster uses engine manifold vacuum to assist braking force. If engine manifold vacuum becomes insufficient, such as when driving in a high-altitude place, a vacuum pump assures a sufficient vacuum to operate the brake booster. Do not turn off the engine while driving because that will turn off the brake booster, resulting in poor braking power.

The brakes will continue to work even when the brake booster completely stops functioning. If this happens, however, you will have to depress the pedal much

harder than normal and the braking distance will increase.

NOTE

Some sound accompanying operation of the vacuum pump may be heard from the engine compartment during driving. This does not indicate a malfunction.

▼ Brake assist system

⚠ WARNING

Do not be overconfident about the brake assist. It is not a system that brings more braking ability to the vehicle beyond its braking capability. Always use the utmost care when driving regarding vehicle speed and safe distance.

⚠ CAUTION

When you need to brake suddenly, continue depressing the brake pedal strongly to bring the effect of the brake assist.

NOTE

When you depress the brake pedal

suddenly, the brake pedal might wiggle. This is a normal operation phenomenon, and it is not a malfunction.

Brake assist is a driver assistance system. It assists the brake power when the driver cannot depress the brake pedal strongly and the brake power is insufficient.

Brake assist generates the brake power according to the speed at which the driver depresses the brake pedal.

■ Disc brake pad wear warning indicators

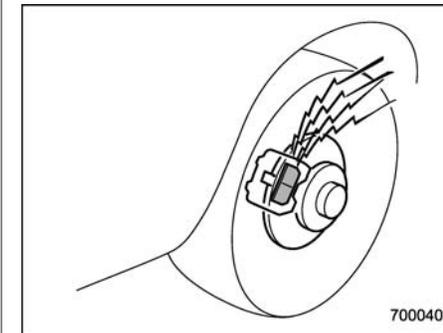

The disc brake pad wear warning indicators on the disc brakes give a warning noise when the brake pads are worn.

If a squeaking or scraping noise is heard from the disc brakes while braking, im-

– CONTINUED –

mediately have your vehicle inspected by the nearest SUBARU dealer.

ABS (Anti-lock Brake System)

 **WARNING**

Always use the utmost care in driving – overconfidence because you are driving with an ABS equipped vehicle could easily lead to a serious accident.

 **CAUTION**

- **The ABS system does not always decrease stopping distance. You should always maintain a safe following distance from other vehicles.**
- **When driving on badly surfaced roads, gravel roads, icy roads, or over deep newly fallen snow, stopping distances may be longer for a vehicle with the ABS system than one without. When driving under these conditions, therefore, reduce your speed and leave ample distance from other vehicles.**
- **When you feel the ABS system operating, you should maintain**

constant brake pedal pressure. Do not pump the brake pedal since doing so may defeat the operation of the ABS system.

The ABS system prevents the lock-up of wheels which may occur during sudden braking or braking on slippery road surfaces. This helps prevent the loss of steering control and directional stability caused by wheel lock-up.

When the ABS system is operating, you may hear a chattering noise or feel a slight vibration in the brake pedal. This is normal when the ABS operates.

The ABS system will not operate when the vehicle speed is below approximately 6 mph (10 km/h).

■ ABS system self-check

You may feel a slight shock in the brake pedal and hear the operating sound of ABS from the engine compartment just after the vehicle is started. This is caused by an automatic functional test of the ABS system being carried out and does not indicate any abnormal condition.

■ ABS warning light

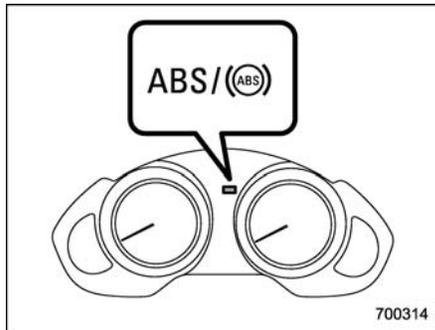

The ABS warning light illuminates when the ignition switch is turned to the "ON" position and turns off after approximately 2 seconds.

This is an indication that the ABS system is working properly.

⚠ CAUTION

If the warning light behaves as follows, the ABS system may not be working properly.

When the warning light illuminates, the ABS function shuts down; however, the conventional brake system continues to operate normally.

- The warning light does not illu-

minate when the ignition switch is turned to the "ON" position.

- The warning light illuminates when the ignition switch is turned to the "ON" position, but it does not turn off even when the vehicle speed exceeds approximately 8 mph (12 km/h).
- The warning light illuminates during driving.

If these occur, have the ABS system repaired at the first available opportunity by your SUBARU dealer.

NOTE

If the warning light behavior is as described in the following, the ABS system may be considered normal.

- The warning light illuminates right after the engine is started but turns off immediately, remaining off.
- The warning light remains illuminated after the engine has been started, but it turns off when the vehicle speed reaches approximately 8 mph (12 km/h).
- The warning light illuminates during driving, but it turns off immediately and remains off.

When driving with an insufficient battery

voltage such as when the engine is jump started, the ABS warning light may illuminate. This is due to the low battery voltage and does not indicate a malfunction. When the battery becomes fully charged, the light will turn off.

Electronic Brake Force Distribution (EBD) system

The EBD system maximizes the effectiveness of the brakes by allowing the rear brakes to supply a greater proportion of the braking force. It functions by adjusting the distribution of braking force to the rear wheels in accordance with the vehicle's loading condition and speed.

The EBD system is an integral part of the ABS system and uses some of the ABS system's components to perform its function of optimizing the distribution of braking force. If any of the ABS components used by the EBD function fails, the EBD system also stops working.

When the EBD system is operating, you may hear a chattering noise or feel a slight vibration in the brake pedal. This is normal and does not indicate a malfunction.

■ Steps to take if EBD system fails

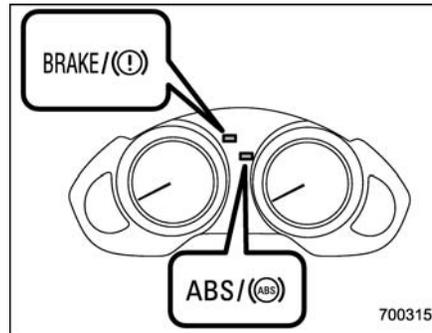

If a malfunction occurs in the EBD system, the system stops working and the brake system warning light and ABS warning light illuminate simultaneously.

The EBD system may be malfunctioning if the brake system warning light and ABS warning light illuminate simultaneously during driving.

Even if the EBD system fails, the conventional braking system will still function. However, the rear wheels will be more prone to locking when the brakes are applied harder than usual and the vehicle's motion may therefore become somewhat harder to control.

If the brake system warning light and ABS

warning light illuminate simultaneously, take the following steps:

1. Stop the vehicle in the nearest safe, flat place.
2. Shut down the engine, apply the parking brake, and then restart it.
3. Release the parking brake. If both warning lights turn off, the EBD system may be malfunctioning.

Drive carefully to the nearest SUBARU dealer and have the system inspected.

4. If both warning lights illuminate again and remain illuminated after the engine has been restarted, shut down the engine again, apply the parking brake, and check the brake fluid level.

5. If the brake fluid level is not below the "MIN" mark, the EBD system may be malfunctioning. Drive carefully to the nearest SUBARU dealer and have the system inspected.

6. If the brake fluid level is below the "MIN" mark, DO NOT drive the vehicle. Instead, have the vehicle towed to the nearest SUBARU dealer for repair.

WARNING

- Driving with the brake system warning light illuminated is dangerous. This indicates your brake

system may not be working properly. If the light remains illuminated, have the brakes inspected by a SUBARU dealer immediately.

- If at all in doubt about whether the brakes are operating properly, do not drive the vehicle. Have your vehicle towed to the nearest SUBARU dealer for repair.

Vehicle Dynamics Control system

WARNING

Always use the utmost care in driving – overconfidence because you are driving with a Vehicle Dynamics Control system equipped vehicle could easily lead to a serious accident.

CAUTION

- Even if your vehicle is equipped with Vehicle Dynamics Control, winter tires or snow chains should be used when driving on snow-covered or icy roads; in addition, vehicle speed should be reduced considerably. Simply having a Vehicle Dynamics Control system does not guarantee that the vehicle will be able to avoid accidents in any situation.
- Activation of the Vehicle Dynamics Control system is an indication that the road being travelled on has a slippery surface; since having Vehicle Dynamics Control is no guarantee

that full vehicle control will be maintained at all times and under all conditions, its activation should be seen as a sign that the speed of the vehicle should be reduced considerably.

- Whenever suspension components, steering components, or an axle are removed from a vehicle equipped with Vehicle Dynamics Control, have an authorized SUBARU dealer perform an inspection of that system.
- The following precautions should be observed in order to ensure that the Vehicle Dynamics Control system is operating properly:
 - All four wheels should be fitted with tires of the same size, type, and brand. Furthermore, the amount of wear should be the same for all four tires.
 - Keep the tire pressure at the proper level as shown on the vehicle placard attached to the driver's side door pillar.

In the event of wheelspin and/or skidding on a slippery road surface and/or during

– CONTINUED –

cornering and/or an evasive maneuver, the Vehicle Dynamics Control system adjusts the engine's output and the wheels' respective braking forces to help maintain traction and directional control.

● **Traction Control Function**

The traction control function is designed to prevent spinning of the driving wheels on slippery road surfaces, thereby helping to maintain traction and directional control. Activation of this function is shown by steady illumination of the Vehicle Dynamics Control operation indicator light.

● **Skid Suppression Function**

The skid suppression function is designed to help maintain directional stability by suppressing the wheels' tendency to slide sideways during steering operations. Activation of this function is shown by flashing of the Vehicle Dynamics Control operation indicator light.

NOTE

- Slight twitching of the brake pedal may be felt when the Vehicle Dynamics Control system operates; a small degree of vehicle or steering wheel shaking may also be noticed in this situation. These are normal characteristics of Vehicle Dynamics Control operation and are no cause for alarm.
- When driving off immediately after

starting the engine, a short operation noise may be noticed coming from the engine compartment. This noise is generated as a result of a check being performed on the Vehicle Dynamics Control system and is normal.

- Depending on the timing of activation of the brakes, the brake pedal may seem to jolt when you drive off after starting the engine. This is a consequence of the Vehicle Dynamics Control operational check and is normal.

- In the circumstances listed in the following, the vehicle may be more unstable than it feels to the driver. The Vehicle Dynamics Control System may therefore operate. Such operation does not indicate a system malfunction.

- on gravel-covered or rutted roads
- on unfinished roads
- when the vehicle is towing a trailer
- when the vehicle is fitted with snow tires or winter tires
- Activation of the Vehicle Dynamics Control system will cause operation of the steering wheel to feel slightly different compared to that for normal conditions.
- Even if the vehicle is equipped with a Vehicle Dynamics Control system, it is important that winter tires be used

when driving on snow-covered or icy roads. (All four wheels should be fitted with tires of the same size and brand). Furthermore, if snow chains are to be used, they should be fitted on the front wheels. When a vehicle is fitted with snow chains, however, the effectiveness of the Vehicle Dynamics Control system is reduced and this should be taken into account when driving the vehicle in such a condition.

- It is always important to reduce speed when approaching a corner, even if the vehicle is equipped with Vehicle Dynamics Control.
- All four wheels should be fitted with tires of the same size, type, and brand; furthermore, the amount of wear should be the same for all four tires. If these precautions are not observed and non-matching tires are used, it is quite possible that the Vehicle Dynamics Control system will be unable to operate correctly as intended.
- Always turn off the engine before replacing a tire as failure to do so may render the Vehicle Dynamics Control system unable to operate correctly.

■ Vehicle Dynamics Control system monitor

▼ Vehicle Dynamics Control operation indicator light

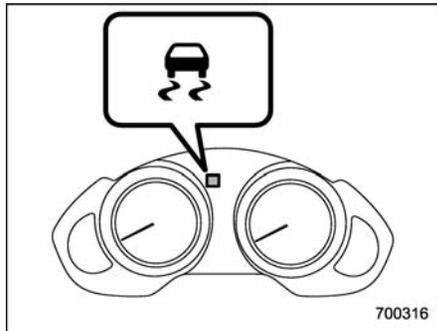

The indicator light illuminates when the ignition key is turned to the ON position; it turns off approximately 2 seconds later. This indicator light flashes during activation of the skid suppression function and is illuminated steadily during activation of the traction control function.

The following two situations could indicate a malfunction of the Vehicle Dynamics Control system; if either should occur, have an authorized SUBARU dealer carry out an inspection of that system at the first available opportunity.

- The indicator light does not illuminate

when the ignition key is turned to the ON position.

- The indicator light does not turn off approximately 2 seconds after the ignition key has been turned to the ON position.

▼ Vehicle Dynamics Control warning light/Traction Control system OFF indicator light

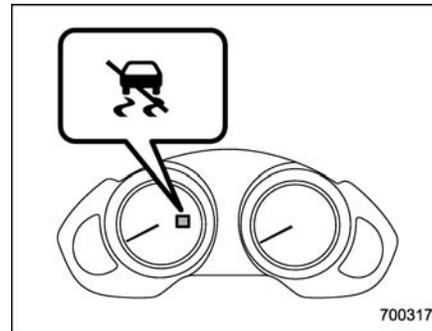

This single light has the function of indicating malfunctions in the Vehicle Dynamics Control system and the function of indicating that the Traction Control system is not operating. It illuminates in the event of a malfunction in the system and is illuminated whenever the system is not operating.

▽ Vehicle Dynamics Control warning

The warning light illuminates when the ignition switch is turned to the "ON" position and turns off several seconds after engine startup. This lighting pattern indicates that the Vehicle Dynamics Control system is operating normally.

The following situations could indicate a malfunction of the Vehicle Dynamics Control system; if any should occur, we recommend that you have an authorized SUBARU dealer carry out an inspection of the system at the first available opportunity.

- The warning light does not illuminate when the ignition key is turned to the ON position.
- The warning light illuminates while the vehicle is being driven.
- When a malfunction has occurred in the Vehicle Dynamics Control electrical system, only the warning light will illuminate. In such an event, the ABS will still be operating normally.
- The warning light will also illuminate when a problem occurs with the ABS or Vehicle Dynamics Control electronic control systems.

Because the Vehicle Dynamics Control system controls each brake through the ABS, whenever the ABS stops operating

– CONTINUED –

due to a malfunction in that electrical system, the Vehicle Dynamics Control will also become unable to control all four brakes. Thus Vehicle Dynamics Control system operation halts and the warning light illuminates. Although both the Vehicle Dynamics Control system and the ABS will be inoperable in this situation, it will still be possible to stop the vehicle using normal braking. The Vehicle Dynamics Control system and the ABS do not adversely affect operation of the vehicle in any way when they are inoperable; however should such a situation occur, drive with care and have an authorized SUBARU dealer carry out an inspection of those systems at the first available opportunity.

NOTE

When the warning light illuminates and turns off in the following way, it indicates that the Vehicle Dynamics Control system is operating normally.

- Although illuminating after the engine has been started, the warning light quickly turns off and remains off.
- The warning light illuminates when the vehicle is being driven; it then turns off and remains off.

▽ Traction Control system OFF indicator light

This light illuminates to indicate that the Traction Control system is in non-operation mode. This does not constitute failure of the Vehicle Dynamics Control system.

NOTE

- The indicator light may remain illuminated for a while after the engine has been started, especially in cold weather. This occurs because the engine has not yet warmed up and is completely normal. The light will turn off when the engine has reached a suitable operating temperature.
- When an engine problem occurs and the malfunction indicator lamp illuminates, the indicator light will also illuminate.

The following two situations could indicate malfunction of the Vehicle Dynamics Control system; if either should occur, have an authorized SUBARU dealer carry out an inspection of that system at the first available opportunity.

- The indicator light does not illuminate when the ignition key is turned to the ON position.
- The indicator light fails to turn off after the engine is started, even when several minutes have passed to allow the engine

to heat up sufficiently.

■ Traction Control system OFF switch

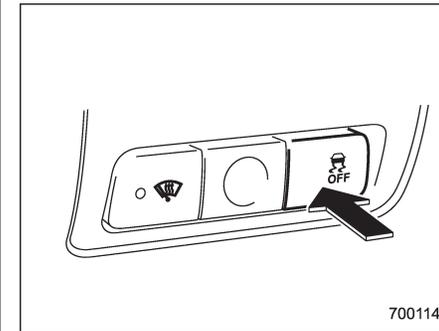

Pressing the switch to deactivate the Traction Control system can facilitate the following operations:

- a standing start on a steeply sloping road with a snowy, gravel-covered, or otherwise slippery surface
- extrication of the vehicle when its wheels are stuck in mud or deep snow

When the switch is pressed during engine operation, the Traction Control system OFF indicator light "OFF" on the combination meter illuminates. The Traction Control system will be deactivated and the vehicle will behave like a model not equipped with

the Traction Control system. When the switch is pressed again to reactivate the Traction Control system OFF indicator light “” turns off.

With the Traction Control system deactivated, traction enhancement offered by Traction Control system is unavailable. Therefore you should not deactivate the Traction Control system except under above-mentioned situations.

NOTE

- When the switch has been pressed to deactivate the Traction Control system, the Traction Control system automatically reactivates itself the next time the ignition key is turned to the “LOCK” position and the engine is restarted.
- If the switch is held down for 10 seconds or longer, the indicator light turns off, the Traction Control system is activated, and the system ignores any further pressing of the switch. To make the switch usable again, turn the ignition key to the “LOCK” position and restart the engine.
- When the switch is pressed to deactivate the Traction Control system, the vehicle’s running performance is comparable with that of a vehicle that does not have a Traction Control system. Do not deactivate the Traction

Control system except when absolutely necessary.

Tire pressure monitoring system (TPMS)

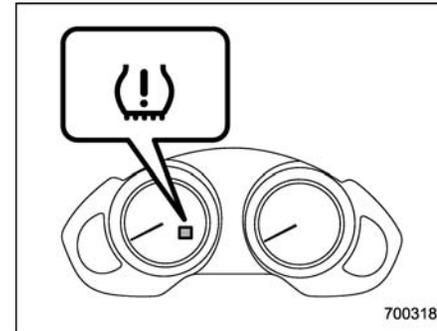

The tire pressure monitoring system provides the driver with a warning message by sending a signal from a sensor that is installed in each wheel when tire pressure is severely low.

The tire pressure monitoring system will activate only when the vehicle is driven at speeds above 20 mph (32 km/h). Also, this system may not react immediately to a sudden drop in tire pressure (for example, a blow-out caused by running over a sharp object).

– CONTINUED –



WARNING

If the low tire pressure warning light illuminates while driving, never brake suddenly and keep driving straight ahead while gradually reducing speed. Then slowly pull off the road to a safe place. Otherwise an accident involving serious vehicle damage and serious personal injury could occur.

Check the pressure for all four tires and adjust the pressure to the COLD tire pressure shown on the tire placard on the door pillar on the driver's side.

Even when the vehicle is driven a very short distance, the tires get warm and their pressures increase accordingly. Be sure to let the tires cool thoroughly before adjusting their pressures to the standard values shown on the tire placard. (Refer to the "Tires and wheels" section in chapter 11.) The tire pressure monitoring system does not function when the vehicle is stationary. After adjusting the tire pressures, increase the vehicle speed to at least 20 mph (32 km/h) to start the TPMS re-checking of the tire inflation pressures. If the tire

pressures are now above the severe low pressure threshold, the low tire pressure warning light should turn off a few minutes later.

If this light still illuminates while driving after adjusting the tire pressure, a tire may have significant damage and a fast leak that causes the tire to lose air rapidly. If you have a flat tire, replace it with a spare tire as soon as possible.

When a spare tire is mounted or a wheel rim is replaced without the original pressure sensor/transmitter being transferred, the low tire pressure warning light will illuminate steadily after blinking for approximately one minute. This indicates the TPMS is unable to monitor all four road wheels. Contact your SUBARU dealer as soon as possible for tire and sensor replacement and/or system resetting.

Do not inject any tire liquid or aerosol tire sealant into the tires, as this may cause a malfunction of the tire pressure sensors. If the light illuminates steadily after blinking for approximately one minute, promptly contact a SUBARU dealer to have the system inspected.



CAUTION

Do not place metal film or any metal parts under the driver's seat. This may cause poor reception of the signals from the tire pressure sensors, and the tire pressure monitoring system will not function properly.

NOTE

This device complies with Part 15 of the FCC Rules and with RSS-210 of Industry Canada. Operation is subject to the following two conditions: (1) This device may not cause harmful interference, and (2) this device must accept any interference received, including interference that may cause undesired operation.

Changes or modifications not expressly approved by the party responsible for compliance could void the user's authority to operate the equipment.

Parking your vehicle

WARNING

- Never leave unattended children or pets in the vehicle. They could accidentally injure themselves or others through inadvertent operation of the vehicle. Also, on hot or sunny days, the temperature in a closed vehicle could quickly become high enough to cause severe or possibly fatal injuries to them.
- Do not park the vehicle over flammable materials such as dry grass, waste paper or rags, as they may burn easily if they come near hot engine or exhaust system parts.
- Be sure to stop the engine if you take a nap in the vehicle. If engine exhaust gas enters the passenger compartment, occupants in the vehicle could die from carbon monoxide (CO) contained in the exhaust gas.

■ Parking brake

CAUTION

- Never drive while the parking brake is set because this will cause unnecessary wear on the brake linings. Before starting to drive, always make sure that the parking brake has been fully released.
- Never drive with your foot on the parking brake pedal.

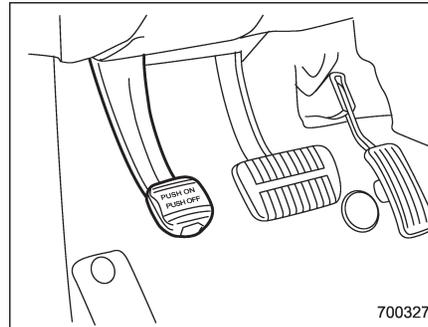

To set the parking brake, hold down the brake pedal while depressing the parking brake pedal as far as it will go.

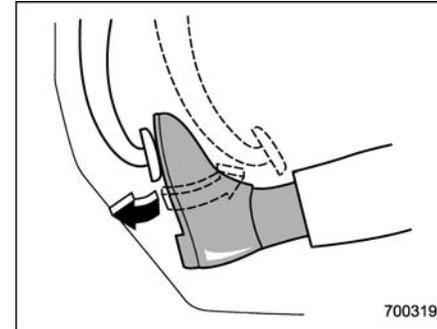

To release the parking brake, hold down the brake pedal while depressing the parking brake pedal and slowly releasing it.

When the parking brake is set while the engine is running, the brake system warning light illuminates. After starting the vehicle, be sure that the warning light has turned off before the vehicle is driven. Refer to the "Warning and indicator lights" section in chapter 3.

■ Parking tips

When parking your vehicle, always set the parking brake firmly and put the selector lever in the "P" (Park) position. Always set the parking brake firmly when parking your vehicle. Never rely on the transmission alone to hold the vehicle.

– CONTINUED –

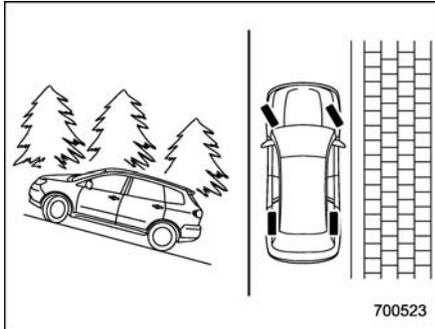

When parking on a hill, always turn the steering wheel. When the vehicle is headed up the hill, the front wheels should be turned away from the curb.

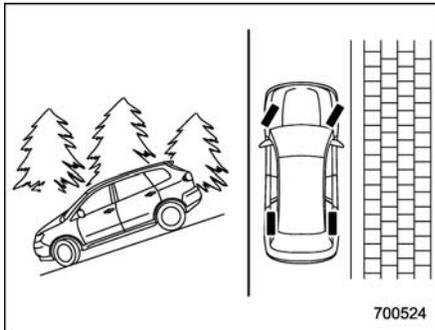

When facing downhill, the front wheels should be turned into the curb.

Cruise control

Cruise control enables you to maintain a constant vehicle speed without holding your foot on the accelerator pedal and it is operative when the vehicle speed is 25 mph (40 km/h) or more. Make sure the main switch is turned “OFF” when the cruise control is not in use to avoid unintentionally setting the cruise control.

NOTE

If you move the cruise control lever or press the main switch button while turning the ignition switch “ON”, the cruise control function is deactivated and the cruise control indicator light flashes. To reactivate the cruise control function, turn the ignition switch back to the “Acc” or “LOCK” position, and then turn it again to the “ON” position.

WARNING

Do not use the cruise control under any of the following conditions. This may cause loss of vehicle control:

- driving up or down a steep grade
- driving on slippery or winding roads
- driving in heavy traffic

To set cruise control

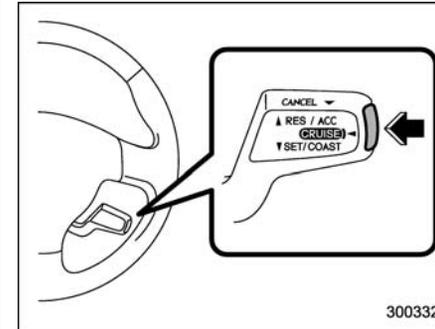

1. Push the main switch button.

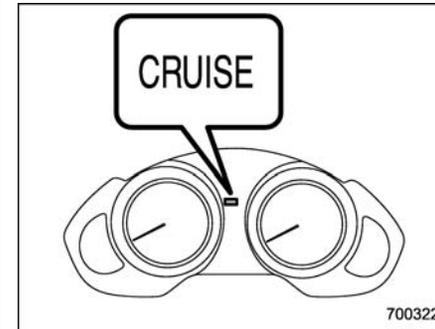

The cruise control indicator light on the combination meter will illuminate.

2. Depress the accelerator pedal until the

vehicle reaches the desired speed.

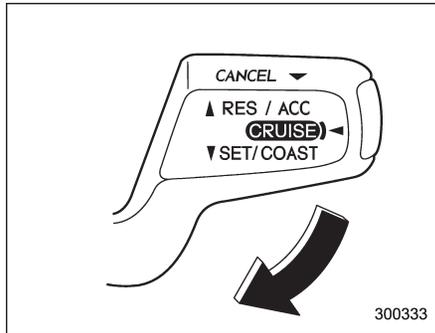

3. Push the control lever downward in the “SET/COAST” direction and release it. Then release the accelerator pedal.

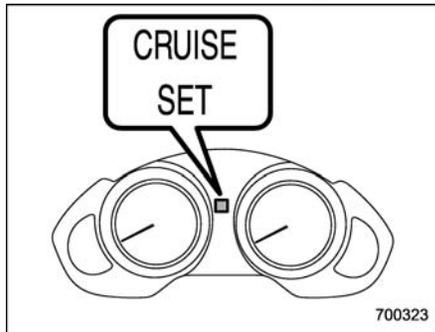

At this time, the cruise control set indicator light is illuminated on the combination

meter.

The vehicle will maintain the desired speed.

Vehicle speed can be temporarily increased while driving with the cruise control activated. Simply depress the accelerator pedal to accelerate the vehicle. When the accelerator pedal is released, the vehicle will return to and maintain the previous cruising speed.

■ To temporarily cancel the cruise control

There are three ways to cancel the cruise control temporarily:

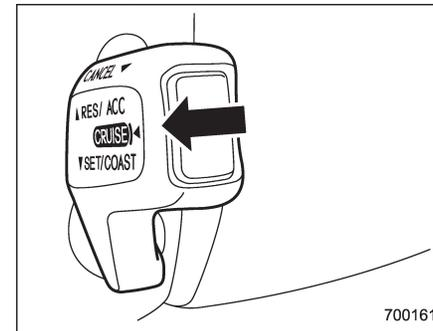

- Pull the control lever toward you.
- Depress the brake pedal.
- Shift the selector lever into the “N”

position.

The cruise control set indicator light on the combination meter turns off when the cruise control is canceled.

To resume the cruise control after it has been temporarily canceled and with vehicle speed of approximately 20 mph (32 km/h) or more, push the control lever upward in the “RES/ACC” direction to return to the original cruising speed automatically.

The cruise control set indicator light on the combination meter will automatically illuminate at this time.

■ To turn off the cruise control

There are two ways to turn off the cruise control:

- Push the main switch again.
- Turn the ignition switch to the “Acc” or “LOCK” position (but only when the vehicle is completely stopped).

■ To change the cruising speed

▼ To increase the speed (by control lever)

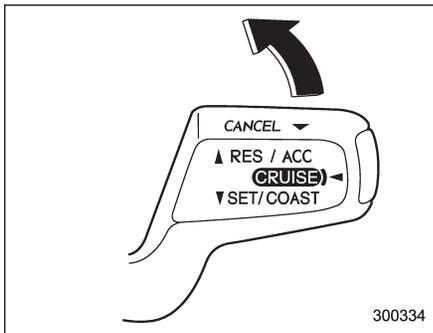

Push the control lever upward in the “RES/ACC” direction and hold it until the vehicle reaches the desired speed. Then, release the control lever. The vehicle speed at that moment will be memorized and treated as the new set speed.

When the difference between the actual vehicle speed and the set speed is less than 4 mph (6.8 km/h), the set speed can be increased 1 mph (1.6 km/h) each time by pressing the control lever upward in the “RES/ACC” direction quickly.

▼ To increase the speed (by accelerator pedal)

1. Depress the accelerator pedal to accelerate the vehicle to the desired speed.
2. Push the control lever downward in the “SET/COAST” direction once. Now the desired speed is set and the vehicle will keep running at that speed without depressing the accelerator pedal.

NOTE

If the difference between the actual vehicle speed when the control lever is pushed downward and the speed last time you set is less than 4 mph (6.8 km/h), the vehicle speed will be lowered by 1 mph (1.6 km/h). This occurs because the cruise control system unit regards this lever operation as that intended to decrease the vehicle speed.

▼ To decrease the speed (by control lever)

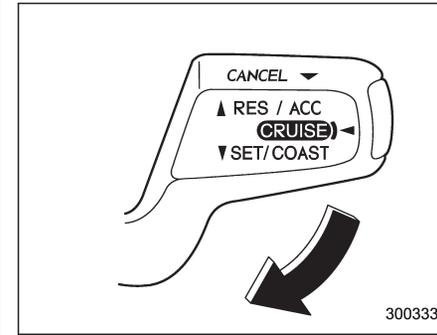

Push the control lever downward in the “SET/COAST” direction and hold it until the vehicle reaches the desired speed. Then, release the control lever. The vehicle speed at that moment will be memorized and treated as the new set speed.

When the difference between the actual vehicle speed and the set speed is less than 4 mph (6.8 km/h), the set speed can be lowered 1 mph (1.6 km/h) each time by pressing the control lever downward in the “SET/COAST” direction quickly.

▼ **To decrease the speed (by brake pedal)**

1. Depress the brake pedal to release cruise control temporarily.
2. When the speed decreases to the desired speed, press the control lever downward in the "SET/COAST" direction once. Now the desired speed is set and the vehicle will keep running at that speed without depressing the accelerator pedal.

■ **Cruise control indicator light**

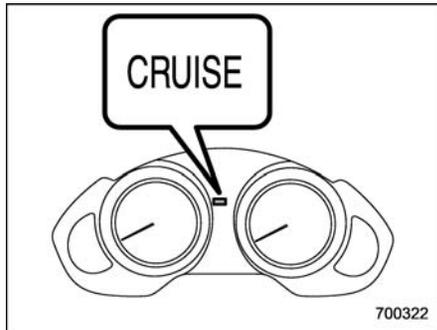

The cruise control indicator light illuminates when the ignition switch is turned to the "ON" position and turns off after approximately 3 seconds.

The light illuminates when the "CRUISE" main switch is pressed.

If you move the cruise control lever while turning the ignition switch "ON", the cruise control function is deactivated and the cruise control indicator light flashes. To reactivate the cruise control function, turn the ignition switch back to the "Acc" or "LOCK" position, and then turn it again to the "ON" position.

■ **Cruise control set indicator light**

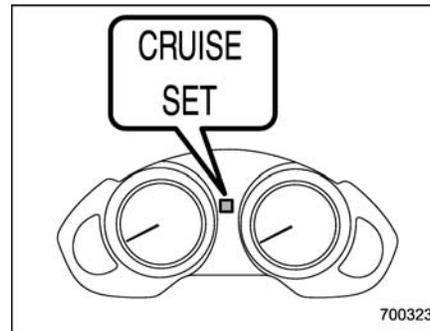

The cruise control set indicator light illuminates when the ignition switch is turned to the "ON" position and turns off after approximately 3 seconds.

The light illuminates when vehicle speed has been set.

Driving tips

New vehicle break-in driving – the first		
1,000 miles (1,600 km)	8-2	
Fuel economy hints	8-2	
Engine exhaust gas (carbon monoxide).....	8-2	
Catalytic converter	8-3	
Periodic inspections	8-4	
Driving in foreign countries	8-4	
Driving tips for AWD vehicles	8-4	
On-pavement and off road driving.....	8-5	
Winter driving	8-7	
Operation during cold weather.....	8-7	
Driving on snowy and icy roads	8-9	
Corrosion protection	8-10	
Snow tires	8-10	
Tire chains.....	8-11	
Rocking the vehicle.....	8-11	
Loading your vehicle.....	8-11	
Vehicle capacity weight.....	8-12	
GVWR and GAWR (Gross Vehicle Weight Rating and Gross Axle Weight Rating)	8-12	
Roof rails and crossbar (if equipped).....	8-13	
Roof molding and crossbar (if equipped).....	8-16	
Trailer hitch (if equipped).....	8-18	
Connecting a trailer	8-18	
When you do not tow a trailer	8-20	
Trailer towing	8-20	
Warranties and maintenance	8-20	
Maximum load limits.....	8-20	
Trailer hitches.....	8-23	
Connecting a trailer	8-24	
Trailer towing tips	8-26	

New vehicle break-in driving – the first 1,000 miles (1,600 km)

The performance and long life of your vehicle are dependent on how you handle and care for your vehicle while it is new. Follow these instructions during the first 1,000 miles (1,600 km):

- Do not race the engine. And do not allow engine speed to exceed 4,000 rpm except in an emergency.
- Do not drive at one constant engine or vehicle speed for a long time, either fast or slow.
- Avoid starting suddenly and rapid acceleration, except in an emergency.
- Avoid hard braking, except in an emergency.

The same break-in procedures should be applied to a newly installed or overhauled engine or when brake pads or brake linings are replaced with new ones.

Fuel economy hints

The following suggestions will help to save your fuel.

- Select the proper gear position for the speed and road conditions.
- Avoid sudden acceleration or deceleration. Always accelerate gently until you reach the desired speed. Then try to maintain that speed for as long as possible.
- Do not pump the accelerator and avoid racing the engine.
- Avoid unnecessary engine idling.
- Keep the engine properly tuned.
- Keep the tires inflated to the correct pressure shown on the tire placard, which is located under the door latch on the driver's side. Low pressure will increase tire wear and fuel consumption.
- Use the air conditioner only when necessary.
- Keep the front and rear wheels in proper alignment.
- Avoid carrying unnecessary luggage or cargo.

Engine exhaust gas (carbon monoxide)

 **WARNING**

- **Never inhale engine exhaust gas. Engine exhaust gas contains carbon monoxide, a colorless and odorless gas which is dangerous, or even lethal, if inhaled.**
- **Always properly maintain the engine exhaust system to prevent engine exhaust gas from entering the vehicle.**
- **Never run the engine in a closed space, such as a garage, except for the brief time needed to drive the vehicle in or out of it.**
- **Avoid remaining in a parked vehicle for a lengthy time while the engine is running. If that is unavoidable, then use the ventilation fan to force fresh air into the vehicle.**
- **Always keep the front ventilator inlet grille free from snow, leaves or other obstructions to ensure that the ventilation system always works properly.**
- **If at any time you suspect that**

exhaust fumes are entering the vehicle, have the problem checked and corrected as soon as possible. If you must drive under these conditions, drive only with all windows fully open.

- Keep the rear gate closed while driving to prevent exhaust gas from entering the vehicle.

NOTE

Due to the expansion and contraction of the metals used in the manufacture of the exhaust system, you may hear a crackling sound coming from the exhaust system for a short time after the engine has been shut off. This sound is normal.

Catalytic converter

WARNING

- Avoid fire hazards. Do not drive or park the vehicle anywhere near flammable materials (e.g. grass, paper, rags or leaves), because the catalytic converter operates at very high temperatures.
- Keep everyone and flammable materials away from the exhaust pipe while the engine is running. The exhaust gas is very hot.

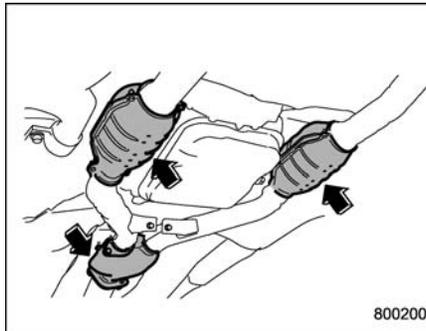

The catalytic converter is installed in the exhaust system. It serves as catalyst to

reduce HC, CO and NOx in exhaust gases, thus providing cleaner exhaust.

To avoid damage to the catalytic converter:

- Use only unleaded gasoline. Even a small amount of leaded gasoline will damage the catalytic converter.
- Never start the engine by pushing or pulling the vehicle.
- Avoid racing the engine.
- Never turn off the ignition switch while the vehicle is moving.
- Keep your engine tuned-up. If you feel the engine running rough (misfiring, back-firing or incomplete combustion), have your vehicle checked and repaired by an authorized SUBARU dealer.
- Do not apply undercoating or rust prevention treatment to the heat shield of catalytic converter and the exhaust system.
- Do not drive with an extremely low fuel level.

Periodic inspections

To keep your vehicle in the best condition at all times, always have the recommended maintenance services listed in the maintenance schedule in the “Warranty and Maintenance Booklet” performed at the specified time or mileage intervals.

Driving in foreign countries

When planning to use your vehicle in another country:

- Confirm the availability of the correct fuel. Refer to the “Fuel requirements” section in chapter 7.
- Comply with all regulations and requirements of each country.

Driving tips for AWD vehicles

 **WARNING**

- **Always maintain a safe driving speed according to the road and weather conditions in order to avoid having an accident on a sharp turn, during sudden braking or under other similar conditions.**
- **Always use the utmost care in driving – overconfidence because you are driving an All-Wheel Drive vehicle could easily lead to a serious accident.**

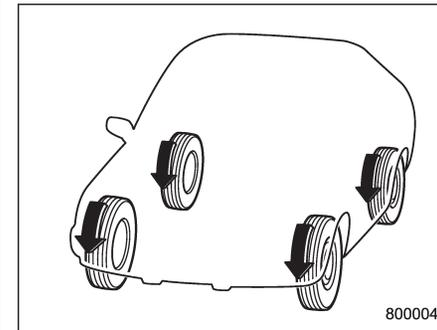

All-Wheel Drive distributes the engine

power to all four wheels. AWD vehicles provide better traction when driving on slippery, wet or snow-covered roads and when moving out of mud, dirt and sand. By shifting power between the front and rear wheels, SUBARU AWD can also provide added traction during acceleration, and added engine braking force during deceleration.

Therefore, your SUBARU AWD vehicle may handle differently than an ordinary two wheel drive vehicle and it contains some features unique to AWD. For safety purposes as well as to avoid damaging the AWD system, you should keep the following tips in mind:

- An AWD vehicle is better able to climb steeper roads under snowy or slippery conditions than a two wheel drive vehicle. There is little difference in handling, however, during extremely sharp turns or sudden braking. Therefore, when driving down a slope or turning corners, be sure to reduce your speed and maintain an ample distance from other vehicles.
- When replacing a tire, make sure you use only the same size, circumference, construction, brand, and load range as the original tires listed on the tire placard. Using other sizes, circumferences or construction may result in severe mechanical damage to the drive train of your

vehicle and may affect ride, handling, braking, speedometer/odometer calibration, and clearance between the body and tires. It also may be dangerous and lead to loss of vehicle control.

- If you use a temporary spare tire to replace a flat tire, be sure to use the original temporary spare tire stored in the vehicle. Using other sizes may result in severe mechanical damage to the drive train of your vehicle.
- Always check the cold tire pressure before starting to drive. The recommended tire pressure is provided on the tire placard, which is located under the door latch on the driver's side.
- Tire chains should always be placed on the front wheels only.
- There are some precautions that you must observe when towing your vehicle. Refer to the "Towing" section in chapter 9 for detailed information.

On-pavement and off road driving

WARNING

- **In a rollover crash, an unbelted person is significantly more likely to die than a person wearing a seat belt. You the driver and all your passengers should fasten the seatbelts before starting to drive in order to minimize the chance of serious injury or death.**
- **Do not make sharp turns and quick maneuvers unless absolutely unavoidable. Such actions are dangerous as you may lose control, possibly resulting in a rollover which could cause death or serious injury.**
- **Always maintain a safe driving speed according to the road and weather conditions in order to avoid having an accident on a sharp turn, during sudden braking or under other similar conditions.**
- **Whenever strong crosswinds are present, slow down sufficiently to maintain control of your vehicle. Remember that your vehicle,**

– CONTINUED –

with its higher profile and center of gravity, is more likely to be affected by crosswinds than ordinary passenger cars.

- **Always use the utmost care in driving – overconfidence because you are driving an All-Wheel Drive vehicle could easily lead to a serious accident.**

Your vehicle is classified as a utility vehicle. Utility vehicles feature a higher ground clearance which enables them to be used for wide applications including off-road driving. But please keep in mind that your vehicle is neither a conventional off-road vehicle nor an all-terrain vehicle. A higher center of gravity in relation to the tread width as compared with ordinary passenger cars makes vehicles of this type more likely to roll over. In reality, utility vehicles have a significantly higher roll-over rate than other types of vehicles. The high ground clearance of this vehicle is a real advantage, giving you a better view of the road and allowing you to anticipate problems earlier. However, remember that your utility vehicle is not designed for high-speed cornering comparable to ordinary passenger cars and that your vehicle could roll over if you make a sharp turn at high speed. If you do take your

SUBARU off-road, certain common sense precautions such as the following should be taken:

- Make certain that you and all of your passengers are wearing seatbelts.
- Carry some emergency equipment, such as a towing rope or chain, a shovel, wheel blocks, first aid kit and cell phone or citizens band radio.
- Drive carefully. Do not take unnecessary risks by driving in dangerous areas or over rough terrain.
- Slow down and employ extra caution at all times. When driving off-road, you will not have the benefit of marked traffic lanes, banked curves, traffic signs and the like.
- Do not drive across steep slopes. Instead, drive either straight up or straight down the slopes. A vehicle can much more easily tip over sideways than it can end over end. Avoid driving straight up or down slopes that are too steep.
- Avoid sharp turning maneuvers, especially at higher speeds.
- Do not grip the inside or spokes of the steering wheel. A bad bump could jerk the wheel and injure your hands. Instead drive with your fingers and thumbs on the outside of the rim.
- If driving through water, such as when

crossing shallow streams, first check the depth of the water and the bottom of the stream bed for firmness and ensure that the bed of the stream is flat. Drive slowly and completely through the stream. The water should be shallow enough that it does not reach the vehicle's undercarriage. Water entering the engine air intake or the exhaust pipe or water splashing onto electrical parts may damage your vehicle and may cause it to stall. Never attempt to drive through rushing water; regardless of its depth, it can wash away the ground from under your tires, resulting in possible loss of traction and even vehicle rollover.

- Always check your brakes for effectiveness immediately after driving in sand, mud or water. Do this by driving slowly and stepping on the brake pedal. Repeat that process several times to dry out the brake discs and brake pads.
- Do not drive or park over or near flammable materials such as dry grass or fallen leaves, as they may burn easily. The exhaust system is very hot while the engine is running and right after engine stops. This could create a fire hazard.
- After driving through tall grass, mud, rocks, sand, rivers, etc., check that there is no grass, bush, paper, rags, stones, sand, etc. adhering to or trapped on the

underbody. Clear off any such matter from the underbody. If the vehicle is used with these materials trapped or adhering to the underbody, a mechanical breakdown or fire could occur.

- Secure all cargo carried inside the vehicle and make certain that it is not piled higher than the seatbacks. During sudden stops or jolts, unsecured cargo could be thrown around in the vehicle and cause injury. Do not pile heavy loads on the roof. Those loads raise the vehicle's center of gravity and make it more prone to tip over.
- If you must rock the vehicle to free it from sand or mud, depress the accelerator pedal slightly and move the selector lever back and forth between "D" and "R" repeatedly. Do not race the engine. For the best possible traction, avoid spinning the wheels when trying to free the vehicle.
- When the road surface is extremely slippery, you can obtain better traction by starting the vehicle with the transmission in 2nd than 1st.
- Never equip your vehicle with tires larger than those specified in this manual.
- Wash the vehicle's underbody after off-road driving. Suspension components are particularly prone to dirt buildup, so they need to be washed thoroughly.
- Frequent driving of an AWD vehicle

under hard-driving conditions such as rough roads or off roads will necessitate more frequent replacement of engine oil, brake fluid and transmission oil than that specified in the maintenance schedule described in the "Warranty and Maintenance Booklet".

Remember that damage done to your SUBARU while operating it off-road and not using common sense precautions such as those listed above is not eligible for warranty coverage.

Winter driving



■ Operation during cold weather

Carry some emergency equipment, such as tire chains, a window scraper, a bag of sand, flares, a small shovel, and jumper cables.

Check the battery and cables. Cold temperatures reduce battery capacity. The battery must be in good condition to provide enough power for cold winter starts.

Use an engine oil of proper grade and viscosity for cold weather. Heavy summer oil will cause harder starting.

Keep the door locks from freezing by

– CONTINUED –

8-8 Driving tips

squirting them with deicer or glycerin.

Forcing a frozen door open may damage or separate the rubber weather strips around the door. If the door is frozen, use hot water to melt the ice, and afterwards thoroughly wipe the water away.

Use a windshield washer fluid that contains an antifreeze solution. Do not use engine antifreeze or other substitutes because they may damage the paint of the vehicle.

SUBARU Windshield Washer Fluid contains 58.5% methyl alcohol and 41.5% surfactant, by volume. Its freezing temperature varies according to how much it is diluted, as indicated in the following table.

Washer Fluid Concentration	Freezing Temperature
30%	10.4°F (-12°C)
50%	-4°F (-20°C)
100%	-49°F (-45°C)

In order to prevent freezing of washer fluid, check the freezing temperatures in the table above when adjusting the fluid concentration to the outside temperature.

If you fill the reservoir tank with a fluid with a different concentration from the one

used previously, purge the old fluid from the piping between the reservoir tank and washer nozzles by operating the washer for a certain period of time. Otherwise, if the concentration of the fluid remaining in the piping is too low for the outside temperature, it may freeze and block the nozzles.

CAUTION

Adjust the washer fluid concentration appropriately for the outside temperature. If the concentration is inappropriate, sprayed washer fluid may freeze on the windshield and obstruct your view, and the fluid may freeze in the reservoir tank.

▼ Before driving your vehicle

Before entering the vehicle, remove any snow or ice from your shoes because that could make the pedals slippery and driving dangerous.

While warming up the vehicle before driving, check that the accelerator pedal, brake pedal, and all other controls operate smoothly.

Clear away ice and snow that has accumulated under the fenders to avoid making steering difficult. During severe

winter driving, stop when and where it is safe to do so and check under the fenders periodically.

▼ Parking in cold weather

WARNING

Snow can trap dangerous exhaust gases under your vehicle. Keep snow clear of the exhaust pipe and from around your vehicle if you park the vehicle in snow with the engine running.

Do not use the parking brake when parking for long periods in cold weather since it could freeze in that position. Instead, observe the following.

1. Place the selector lever in "P" position.
2. Use tire stops under the tires to prevent the vehicle from moving.

When the vehicle is parked in snow or when it snows, raise the wiper blades off the glass to prevent damage to them.

When the vehicle has been left parked after use on roads heavily covered with snow, or has been left parked during a snowstorm, icing may develop on the brake system, which could cause poor braking action. Check for snow or ice buildup on the suspension, disc brakes

and brake hoses underneath the vehicle.

If there is caked snow or ice, remove it, being careful not to damage the disc brakes and brake hoses and ABS harness.

▼ Refueling in cold weather

To help prevent moisture from forming in the fuel system and the risk of its freezing, use of an antifreeze additive in the fuel tank is recommended during cold weather. Use only additives that are specifically designed for this purpose. When an antifreeze additive is used, its effect lasts longer if the tank is refilled whenever the fuel level reaches half empty.

If your SUBARU is not going to be used for an extended period, it is best to have the fuel tank filled to capacity.

■ Driving on snowy and icy roads

WARNING

Do not use the cruise control on slippery roads such as snowy or icy roads. This may cause loss of vehicle control.

CAUTION

Avoid prolonged continuous driving in snowstorms. Snow will enter the engine's intake system and may hinder the air flow, which could result in engine shutdown or even breakdown.

To prevent skidding and slipping, avoid sudden braking, abrupt acceleration, high-speed driving, and sharp turning when driving on snowy or icy roads.

Always maintain ample distance between your vehicle and the vehicle ahead of you to avoid the need for sudden braking.

To supplement the foot brake, use the engine brake effectively to control the vehicle speed. (Shift into a lower gear when necessary.)

Avoid shifting down abruptly. Such behavior can cause the wheels to lock, possibly leading to loss of vehicle control.

An anti-lock brake system (ABS) enhances your vehicle's braking performance on snowy and icy roads. Refer to the "ABS (Anti-lock Brake System)" and "Vehicle Dynamics Control system" section in chapter 7 for information on braking on slippery surfaces.

▼ Wiper operation when snowing

Before driving in cold weather, make sure the wiper blades are not frozen to the windshield or rear window. If the wiper blades are frozen to the windshield or rear window, use the defroster with the airflow control button in the "" position and the temperature control dial set for maximum warmth until the wiper blades are completely thawed out. The wiper deicer is helpful to thaw the windshield wiper blades. To thaw out the rear wiper blade, use the rear window defogger.

When driving in snow, if frozen snow starts to stick on the surface of the windshield despite wiper operation, use the defroster with the airflow control button in "" and the temperature control dial set for maximum warmth. After the windshield gets warmed enough to melt the frozen snow on it, wash it away using the windshield washer.

Snow stuck on the wiper arm prevents the wiper from working effectively. If snow is stuck on the wiper arm, pull off the road to a safe place, then remove it. If you stop the vehicle at road side, use the hazard warning flasher to alert other drivers.

We recommend use of non-freezing type wiper blades (winter blades) during the

seasons you could have snow and sub-zero temperatures. Blades of this type give superior wiping performance in snowy conditions. Be sure to use blades that are suitable for your vehicle.



CAUTION

During high-speed driving, non-freezing type wiper blades may not perform as well as standard wiper blades. If this happens, reduce the vehicle speed.

NOTE

When the season requiring non-freezing type wiper blades is over, replace them with standard wiper blades.

■ **Corrosion protection**

Refer to the “Corrosion protection” section in chapter 10.

■ **Snow tires**



WARNING

- When replacing original tires with winter (snow) tires, make sure you use only the same size and construction as recommended.

Using other sizes or construction may affect speedometer/odometer calibration and clearance between the body and tires. It also may be dangerous and lead to loss of vehicle control.

- You must install four winter tires that are of the same size, circumferences, construction, brand, and load range. Mixing other sizes, circumferences or constructions may result in severe mechanical damage to the drive train of your vehicle and may affect ride, handling, braking and speedometer/odometer calibration. It also may be dangerous and lead to loss of vehicle control.
- Do not use a combination of radial, belted bias or bias tires since it may cause dangerous handling characteristics and lead to an accident.

Your vehicle is equipped with “all season tires” which are designed to provide an adequate measure of traction, handling and braking performance in year-round driving. In winter, it may be possible to enhance performance through use of tires designed specifically for winter driving

conditions.

If you choose to install winter tires on your vehicle, be sure to use the correct tire size and type. You must install four winter tires that are of the same size, construction, brand and load range and you should never mix radial, belted bias or bias tires since this may result in dangerous handling characteristics. When you choose a tire, make sure that there is enough clearance between the tire and vehicle body.

Remember to drive with care at all times regardless of the type of tires on your vehicle.

Your vehicle comes with P255/55R18 “all season tires” as original equipment. You should be aware that some winter tires with that same size designation may actually be too large for the vehicle and may cause rubbing on sharp turns. Listed in the following is the winter tire size that we recommend.

Recommended winter (snow) tire size
P255/55R18 stud less

■ Tire chains

CAUTION

Tire chains cannot be used on tires listed in the following because of lack of clearance between the tires and vehicle body.

All model: P255/55R18 tires

■ Rocking the vehicle

If you must rock the vehicle to free it from snow, sand, or mud, depress the accelerator pedal slightly and move the selector lever back and forth between “D” and “R” repeatedly. Do not race the engine. For the best possible traction, avoid spinning the wheels when trying to free the vehicle.

When the road surface is extremely slippery, you can obtain better traction by starting the vehicle with the transmission in 2nd than 1st.

Refer to the “Automatic transmission” section in chapter 7 for information on holding the transmission in 2nd position.

Loading your vehicle

WARNING

Never allow passengers to ride on a folded rear seatback or in the cargo area. Doing so may result in serious injury.

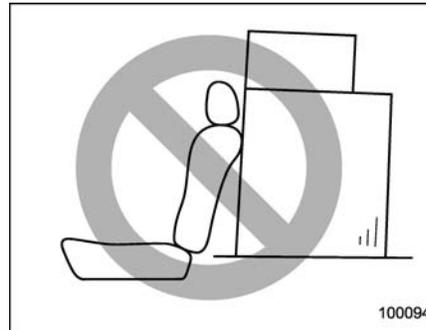

WARNING

• Never stack luggage or other cargo higher than the top of the seatback because it could tumble forward and injure passengers in the event of a sudden stop or accident. Keep luggage or cargo low, as close to the floor as

possible.

- When you carry something inside the vehicle, secure it whenever you can to prevent it from being thrown around inside the vehicle during sudden stops, sharp turns or in an accident.
- Do not pile heavy loads on the roof. These loads raise the vehicle’s center of gravity and make it more prone to tip over.
- Secure lengthy items properly to prevent them from shooting forward and causing serious injury during a sudden stop.
- Never exceed the maximum load limit. If you do, some parts on your vehicle can break, or it can change the way your vehicle handles. This could result in loss of control and cause personal injury. Also, overloading can shorten the life of your vehicle.
- Do not place anything on the extended luggage cover. Such items could tumble forward in the event of a sudden stop or a collision. This could cause serious injury.

CAUTION

Do not carry spray cans, containers with flammable or corrosive liquids or any other dangerous items inside the vehicle.

NOTE

For better fuel economy, do not carry unneeded cargo.

Vehicle capacity weight

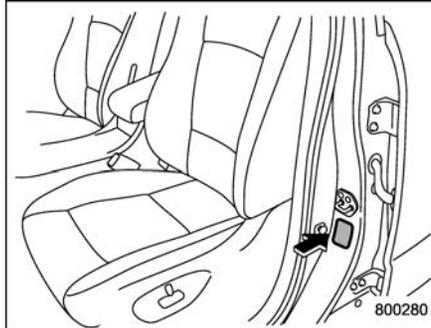
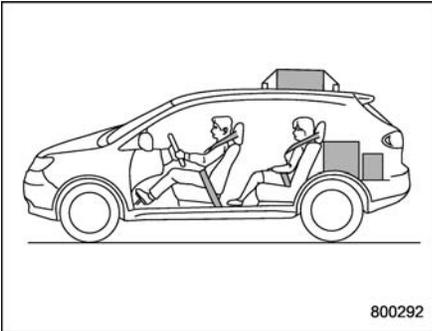

The load capacity of your vehicle is determined by weight, not by available cargo space. The maximum load you can carry in your vehicle is shown on the vehicle placard attached to the driver's side door pillar. It includes the total weight of the driver and all passengers and their belongings, any optional equipment such as a trailer hitch, roof rack or bike carrier, etc., and the tongue load of a trailer.

GVWR and GAWR (Gross Vehicle Weight Rating and Gross Axle Weight Rating)

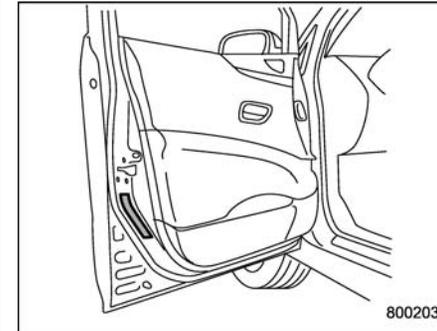

Certification label

The certification label attached to the driver's side door shows GVWR (Gross Vehicle Weight Rating) and GAWR (Gross Axle Weight Rating).

The GVW (Gross Vehicle Weight) must never exceed the GVWR. GVW is the combined total of weight of the vehicle, fuel, driver, all passengers, luggage, any optional equipment and trailer tongue load. Therefore, the GVW changes depending on the situation.

In addition, the total weight applied to each axle (GAW) must never exceed the GAWR. The front and rear GAWs can be

adjusted by relocating luggage inside the vehicle.

Even if the total weight of your luggage is lower than the vehicle capacity weight, either front or rear GAW may exceed the GAWR, depending on the distribution of the luggage.

When possible, the load should be evenly distributed throughout the vehicle.

If you carry heavy loads in the vehicle, you should confirm that GVW and front and rear GAWs are within the GVWR and GAWR by putting your vehicle on a vehicle scale, found at a commercial weighing station.

Do not use replacement tires with a lower load range than the originals because they may lower the GVWR and GAWR limitations. Replacement tires with a higher load range than the originals do not increase the GVWR and GAWR limitations.

■ Roof rails and crossbar (if equipped)

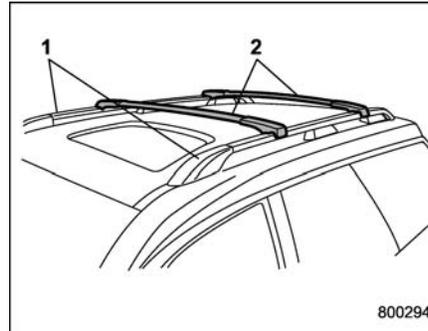

- 1) Roof rails
- 2) Crossbar kit

⚠ CAUTION

- **For cargo carrying purposes, the roof rail must be used together with a roof crossbar kit and the appropriate carrying attachment. The roof rail must never be used alone to carry cargo. Otherwise, damage to the roof or paint or a dangerous road hazard due to loss of cargo could result.**
- **When using the roof crossbar kit, make sure that the total weight of**

the crossbars, carrying attachment and cargo does not exceed the maximum load limit. Overloading may cause damage to the vehicle and create a safety hazard.

The roof rails are not designed to carry cargo by themselves. Cargo can be carried after securing the roof crossbar kit to the roof rail and installing the appropriate carrying attachment. When installing the roof crossbar kit, follow the manufacturer's instructions.

When you carry cargo on the roof using the roof crossbar kit and a carrying attachment, never exceed the maximum load limit as explained below. You should also be careful that your vehicle does not exceed the Gross Vehicle Weight Rating (GVWR) and front and rear Gross Axle Weight Rating (GAWR). Refer to the "Loading your vehicle" section in this chapter for information on loading cargo into or onto your vehicle. The maximum load limit of the cargo, crossbars and carrying attachment must not exceed **150 lbs (68 kg)**. Place the heaviest load at the bottom, nearest the roof, and evenly distribute the cargo. Always properly secure all cargo.

– CONTINUED –

8-14 Driving tips

▼ Installing carrying attachments on the crossbars

When installing any carrying attachment such as a bike carrier, ski carrier, kayak carrier, cargo basket, etc. on the crossbars, follow the manufacturer's instructions and make sure that the attachment is securely fixed to the crossbars. Use only attachments designed specifically for the crossbars. A set of the crossbars is designed to carry loads (cargo and attachment) of not more than **150 lbs (68 kg)**. Before operating the vehicle, make sure that the cargo is properly secured on the attachment.

NOTE

Remember that the vehicle's center of gravity is altered with the weight of the load on the roof, thus affecting the driving characteristics.

Drive carefully. Avoid rapid starts, hard cornering and abrupt stops. Crosswind effects will be increased.

▼ Removal and installation of the crossbars

The crossbars can be removed when you do not use the roof to carry cargo.

▽ To remove the crossbar

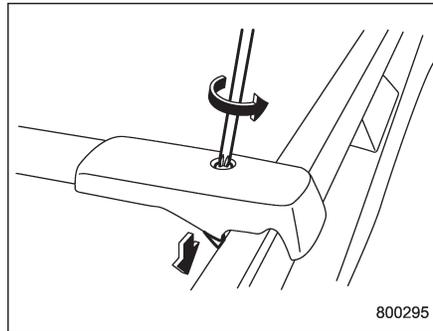

1. Loosen and remove the T-30 torx® head screw from the top of each crossbar end support.

Loosen the lower clamps.

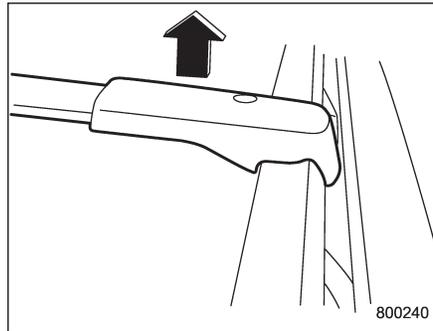

2. Carefully raise the crossbar from roof rails.

▽ To install the crossbar

Front crossbar:

Front crossbar has 150 LBS Load Label on left-hand side.

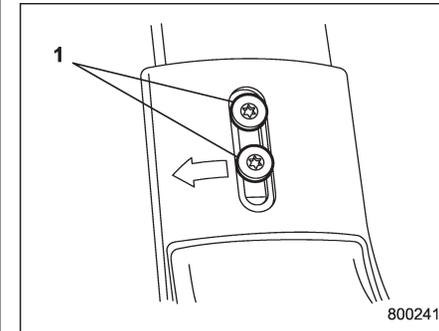

1) T-25 torx® head screw

1. Make sure that the T-25 torx® head screw on the back of each crossbar end support is tightened correctly.

2. Before placing the crossbar on the roof rails, make sure that the T-30 torx® head screw is removed from the top of each crossbar end support.

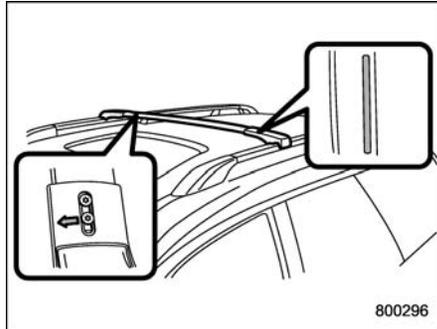

3. The crossbar with the 150 LBS Load Label attached onto it is the front crossbar. An arrow is marked on the back of the front crossbar for correct installation. Install the front crossbar so that the arrow faces the front of the vehicle.

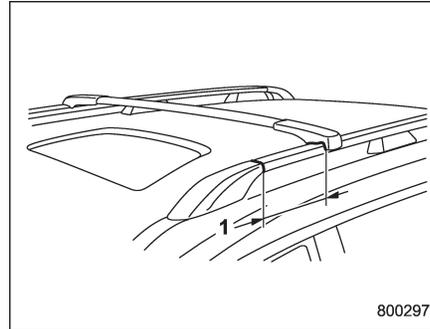

1) 12 in (300 mm)

4. Install the front crossbar so that the crossbar end supports are located approximately 12 in (300 mm) rearward from the joints between the roof rails and the front roof rail supports.

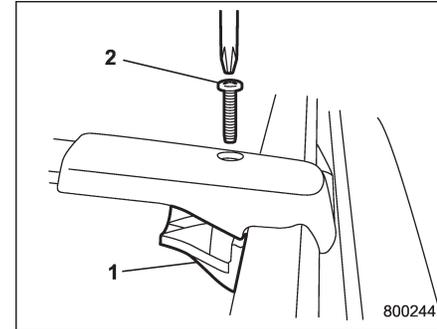

1) Lower clamp
2) T-30 torx® head screw

5. Tighten the lower clamps onto the crossbar. Using a torque wrench, loosely tighten the T-30 torx® head screws.

NOTE

It may be necessary to squeeze the lower clamp and the end support together to compress the pads and gain a better alignment of the pieces while trying to start the screw. Use care not to cross-thread the screw in the insert.

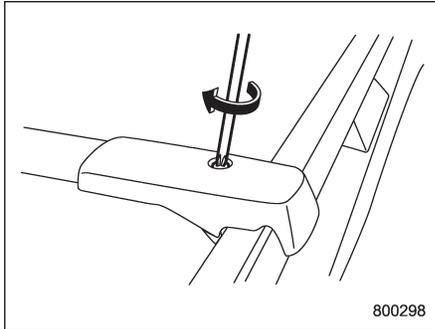

6. Adjust the alignment of the crossbar on the roof rails, and if available, use a T-30 torx® bit and torque wrench and tighten the T-30 torx® head screws to 30 to 35 lbf·in (3.4 to 4.0 N·m, 0.35 to 0.41 kgf·m) of torque (or tighten securely with the torx® wrench provided).

Rear crossbar:

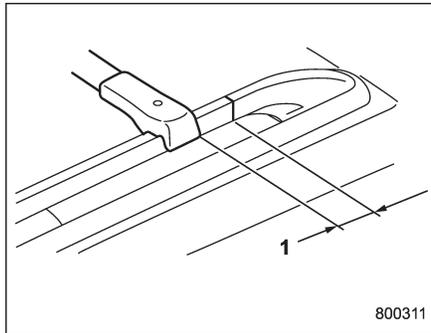

1) 2 in (50 mm)

Install the rear crossbar so that the crossbar end supports are located approximately 2 in (50 mm) forward from the joints between the roof rails and the rear roof rail supports.

Install the rear crossbar in the same manner as the front crossbar.

CAUTION

Do not carry cargo on the roof when the crossbars are removed. Luggage on the roof will be thrown forward or backward in sudden stops or rapid accelerations, resulting in a dangerous road hazard.

NOTE

Before each use of the roof crossbar, make sure the four T-30 crossbar clamp screws have been checked, and retightened if necessary to 35 lbf·in (4.0 N·m, 0.41 kgf·m), as outlined in Step #5 above.

■ Roof molding and crossbar (if equipped)

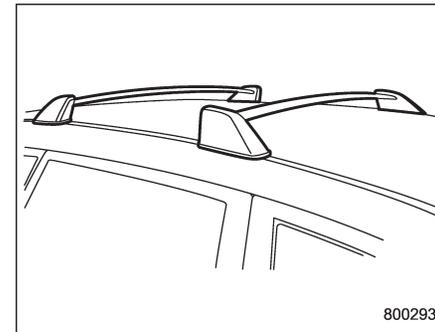

CAUTION

- For cargo carrying purposes, the roof molding must be used together with a roof crossbar kit and the appropriate carrying attachment. Otherwise, damage to the roof or paint or a dangerous

road hazard due to loss of cargo could result.

- **When using the roof crossbar kit, make sure that the total weight of the crossbars, carrying attachment and cargo does not exceed the maximum load limit. Overloading may cause damage to the vehicle and create a safety hazard.**

Cargo can be carried after securing the roof crossbar kit to the roof molding and installing the appropriate carrying attachment. When installing the roof crossbar kit, follow the manufacturer's instructions.

When you carry cargo on the roof using the roof crossbar kit and a carrying attachment, never exceed the maximum load limit as explained below. You should also be careful that your vehicle does not exceed the Gross Vehicle Weight Rating (GVWR) and front and rear Gross Axle Weight Rating (GAWR). Refer to the "Loading your vehicle" section in this chapter for information on loading cargo into or onto your vehicle. The maximum load limit of the cargo, crossbars and carrying attachment must not exceed **150 lbs (68 kg)**. Place the heaviest load at the bottom, nearest the roof, and evenly distribute the cargo. Always properly

secure all cargo.

▼ Installing carrying attachments on the crossbars

When installing any carrying attachment such as a bike carrier, ski carrier, kayak carrier, cargo basket, etc. on the crossbars, follow the manufacturer's instructions and make sure that the attachment is securely fixed to the crossbars. Use only attachments designed specifically for the crossbars. A set of the crossbars is designed to carry loads (cargo and attachment) of not more than **150 lbs (68 kg)**. Before operating the vehicle, make sure that the cargo is properly secured on the attachment.

NOTE

Remember that the vehicle's center of gravity is altered with the weight of the load on the roof, thus affecting the driving characteristics.

Drive carefully. Avoid rapid starts, hard cornering and abrupt stops. Crosswind effects will be increased.

▼ Removal and installation of the crossbars

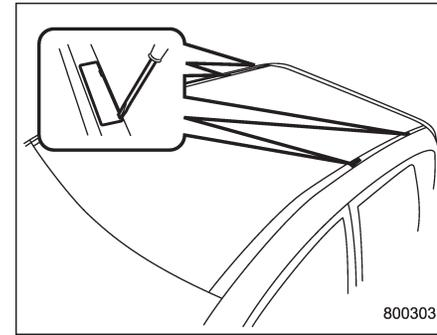

Each of the two roof moldings has two mounting points for crossbars. Each mounting point is fitted with a cover. Use a screwdriver to remove the covers. When installing the crossbars on the roof molding, follow the manufacturer's instructions.

Trailer hitch (if equipped)

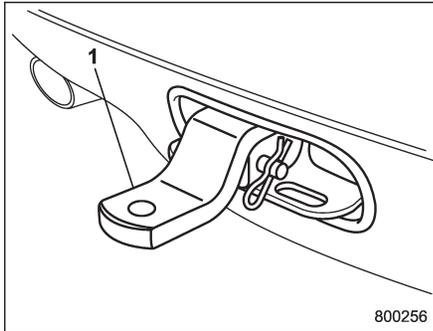

800256

1) Trailer hitch

WARNING

- Never exceed the maximum weight specified for the trailer hitch. Exceeding the maximum weight could cause an accident resulting in serious personal injuries. Permissible trailer weight changes depending on the situation. Refer to the next section “Trailer towing” for possible recommendations and limitations.
- Trailer brakes are required when the towing load exceeds 1,000 lbs (453 kg). Be sure your trailer

has safety chains and that each chain will hold the trailer’s maximum gross weight. Towing trailers without safety chains could create a traffic safety hazard if the trailer separates from the hitch due to coupling damage or hitch ball damage.

- Be sure to check the hitch pin and safety pin for positive locking placement before towing a trailer. If the ball mount comes off the hitch receiver, the trailer could get loose and create a traffic safety hazard.
- Use only the ball mount supplied with this hitch. Use the hitch only as a weight carrying hitch. Do not use with any type of weight distributing hitch.

The maximum gross trailer weight and maximum gross tongue weight are indicated in the following table.

	Maximum gross trailer weight	Maximum gross tongue weight
Vehicle without cooling kit	2,000 lbs (906 kg)	200 lbs (90 kg)
Vehicle with cooling kit	3,500 lbs (1,587 kg)	350 lbs (158 kg)

When you tow a trailer, follow the instructions in the next section “Trailer towing”.

■ Connecting a trailer

1. Remove the receiver cover from the hitch receiver tube. Then insert the ball mount into the hitch receiver tube.

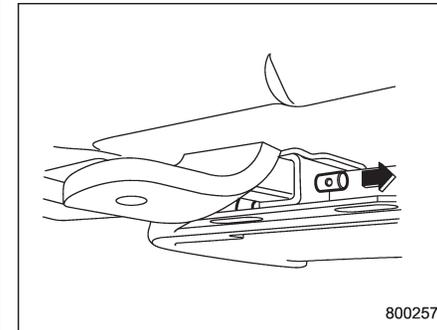

800257

2. Insert the hitch pin into the hole on the hitch receiver tube so that the pin passes through the ball mount.

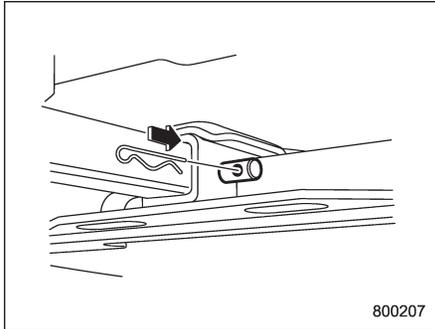

3. Insert the safety pin into the hitch pin securely.
4. Pull the ball mount to make sure it does not come off the hitch receiver.

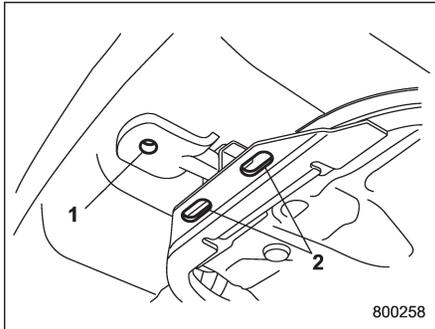

- 1) Hitch ball installation point
- 2) Hooks for safety chains

5. Use only a hitch ball that is appropriate for the ball mount and your trailer. The hitch ball must be securely installed on the ball mount.
6. Connect your trailer to the hitch ball.
7. Connect the trailer and the hitch with safety chains that will hold the trailer's maximum gross weight. The chains should cross under the trailer tongue to prevent the tongue from dropping onto the ground in case it should disconnect from the hitch ball. Allow sufficient slack in the chains taking tight-turn situations into account; however, be careful not to let them drag on the ground.

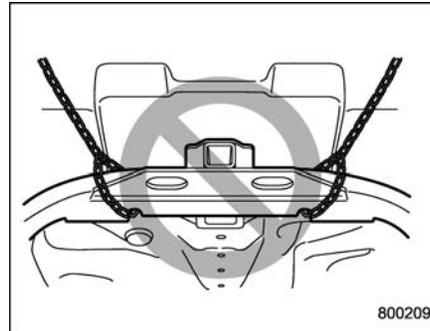

WARNING

Do not connect safety chains to part of the vehicle other than the safety chain hooks.

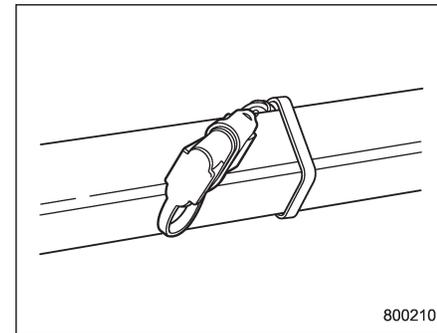

Hitch harness connector

8. Connect the hitch wire harness's black four-pin wire connector to the towing trailer's wire harness.
9. Confirm proper function of the hitch wire harness by individually activating the brake, right turn signal, left turn signal, stop, and parking lights on the trailer.

NOTE

Always disconnect the trailer wire harness before launching or retrieving a

– CONTINUED –

watercraft.

■ **When you do not tow a trailer**

- Remove the ball mount from the hitch receiver tube and insert the receiver cover onto the hitch receiver tube.
- Place the dust cap over the four-pin connector of the hitch wire harness to protect against possible damage.
- Occasionally lubricate terminals of the four-pin connector using the terminal grease.

Trailer towing

Your vehicle is designed and intended to be used primarily as a passenger-carrying vehicle. Towing a trailer puts additional loads on your vehicle's engine, drivetrain, brakes, tires and suspension and has an adverse effect on fuel economy.

If you do decide to tow a trailer, your safety and satisfaction depend upon proper use of correct equipment and cautious operation of your vehicle. Seek the advice of your SUBARU dealer to assist you in purchasing a hitch and other necessary towing equipment appropriate for your vehicle. In addition, be sure to follow the instructions on correct installation and use provided by the trailer and other towing equipment manufacturers.

SUBARU assumes no responsibility for injuries or vehicle damage that result from trailer towing equipment, or from any errors or omissions in the instructions accompanying such equipment or for your failure to follow the proper instructions.

■ **Warranties and maintenance**

SUBARU warranties do not apply to vehicle damage or malfunction caused by trailer towing. If you use your vehicle to tow a trailer, more frequent maintenance will be required due to the additional load.

(Refer to "Maintenance schedule under severe driving conditions" in the "Warranty and Maintenance Booklet".)

Under no circumstances should a trailer be towed with a new vehicle or a vehicle with any new powertrain component (engine, transmission, differential, wheel bearings, etc.) for the first 1,000 miles (1,600 km) of driving.

■ **Maximum load limits**



WARNING

Never exceed the maximum load limits explained in the following. Exceeding the maximum load limits could cause personal injury and/or vehicle damage.



CAUTION

- **Adequate size trailer brakes are required when the trailer and its cargo exceed 1,000 lbs (453 kg) total weight.**
- **Before towing a trailer, check the trailer total weight, GVW, GAWs and tongue load. Make sure the load and its distribution in your vehicle and trailer are accepta-**

ble.

▼ **Total trailer weight**

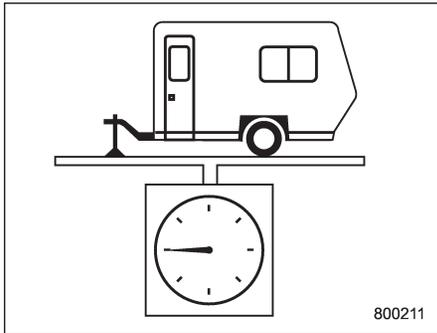

Total trailer weight

The total trailer weight (trailer weight plus its cargo load) must never exceed the maximum weight shown in the following table.

Vehicle without cooling kit

Conditions	Maximum total trailer weight
When towing a trailer without brakes.	1,000 lbs (453 kg)
When towing a trailer with brakes.	2,000 lbs (906 kg)
When towing a trailer on a long uphill grade continuously for over 5 miles (8 km) with an outside temperature of 104°F (40°C) or above.	1,000 lbs (453 kg)

Vehicle with cooling kit

Conditions	Maximum total trailer weight
When towing a trailer without brakes.	1,000 lbs (453 kg)
When towing a trailer with brakes.	3,500 lbs (1,587 kg)
When towing a trailer on a long uphill grade continuously for over 5 miles (8 km) with an outside temperature of 104°F (40°C) or above.	1,750 lbs (794 kg)

▼ **Gross Vehicle Weight (GVW) and Gross Vehicle Weight Rating (GVWR)**

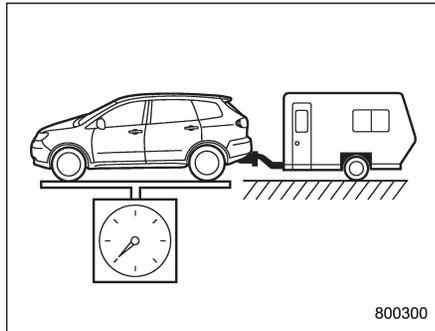

Gross Vehicle Weight

The Gross Vehicle Weight (GVW) must never exceed the Gross Vehicle Weight Rating (GVWR).

Gross Vehicle Weight (GVW) is the combined total of the weight of the vehicle, driver, passengers, luggage, trailer hitch, trailer tongue load and any other optional equipment installed on your vehicle. Therefore, the GVW changes depending on the situation. Determine the GVW each time before going on a trip by putting your vehicle and trailer on a vehicle scale.

GVWR is shown on the certification label located on the driver's door of your vehicle.

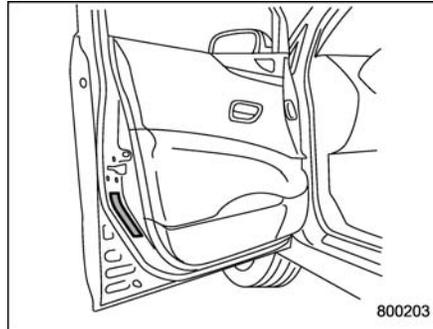

Certification label

▼ **Gross Axle Weight (GAW) and Gross Axle Weight Rating (GAWR)**

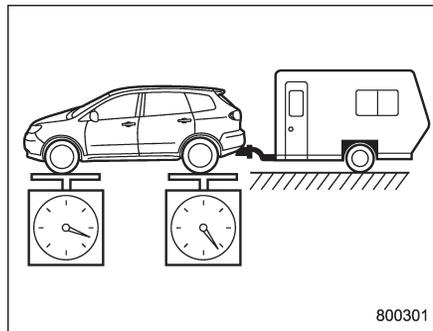

Gross Axle Weight

The total weight applied to each axle

(GAW) must never exceed the Gross Axle Weight Rating (GAWR). The front and rear GAWs can be adjusted by relocating passengers and luggage inside the vehicle. The front and rear GAWR are also shown on the certification label.

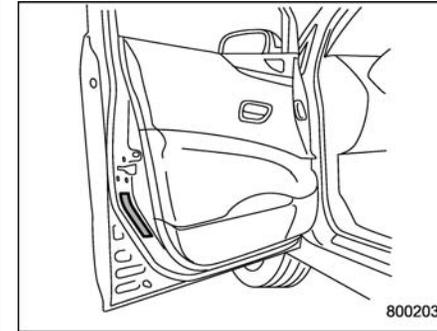

Certification label

To check both GVWR and GAWR and to confirm that the total weight and weight distribution are within safe driving limits, you should have your vehicle and trailer weighed at a commercial weighing station.

Be sure that all cargo is firmly secured to prevent a change in weight distribution while driving.

▼ Tongue load

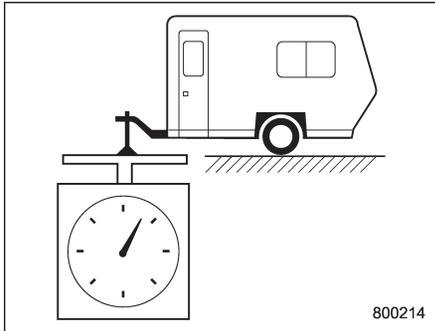

Tongue load

WARNING

If the trailer is loaded with more weight in the back of trailer's axle than in the front, the load is taken off the rear axle of the towing vehicle. This may cause the rear wheels to skid, especially during braking or when vehicle speed is reduced during cornering, resulting in oversteer, spin out and/or jackknifing.

Ensure that the trailer tongue load is from 8 to 11 percent of the total trailer weight and does not exceed the appropriate one of the following maximum values:

Vehicle without cooling kit: 200 lbs (90 kg)
 Vehicle with cooling kit: 350 lbs (158 kg)

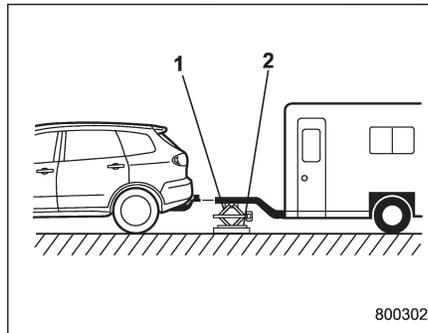

- 1) Jack
- 2) Bathroom scale

The tongue load can be weighed with a bathroom scale as shown in the illustration above. When weighing the tongue load, be sure to position the towing coupler at the height at which it would be during actual towing, using a jack as shown.

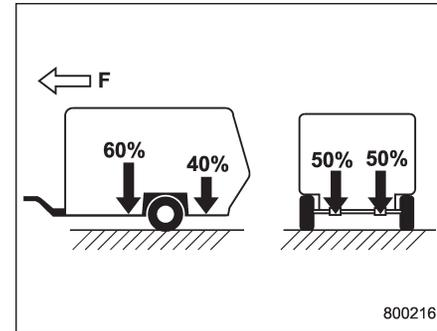

F: Front

The tongue load can be adjusted by proper distribution of the load in the trailer. Never load the trailer with more weight in the back than in the front; approximately 60 percent of the trailer load should be in the front and approximately 40 percent in the rear. Also, distribute the load as evenly as possible on both the left and right sides.

Be sure that all cargo is firmly secured to prevent a change in weight distribution while driving.

■ Trailer hitches

WARNING

Never drill the frame or under-body

- CONTINUED -

of your vehicle to install a commercial trailer hitch. If you do, dangerous exhaust gas, water or mud may enter the passenger compartment through the drilled hole. Exhaust gas contains carbon monoxide, a colorless and odorless gas which is dangerous, or even lethal, if inhaled. Also, drilling the frame or underbody of your vehicle could cause deterioration of strength of your vehicle and cause corrosion around the drilled hole.

 **CAUTION**

- Do not modify the vehicle exhaust system, brake system, or other systems when installing a hitch or other trailer towing equipment.
- Do not use axle-mounted hitches as they can cause damage to the axle housing, wheel bearings, wheels or tires.

Choose a proper hitch for your vehicle and trailer.

The use of a genuine SUBARU trailer hitch is recommended. A genuine SUBARU hitch is available from your

SUBARU dealer.

If use of a non-genuine hitch is unavoidable, be sure the hitch is suited to your vehicle and trailer. Consult with a professional hitch supplier to assist you in choosing an appropriate hitch for your vehicle. Be sure to follow all of the hitch manufacturer's instructions for installation and use.

Never use a hitch that mounts only to the rear bumper. The bumper is not designed to handle that type of load.

For all types of hitches, regularly check that the hitch mounting bolts and nuts are tight.

■ Connecting a trailer

▼ **Trailer brakes**

 **WARNING**

- Adequate size trailer brakes are required when the trailer and its cargo exceed 1,000 lbs (453 kg) total weight.
- Do not directly connect your trailer's hydraulic brake system to the hydraulic brake system in your vehicle. Direct connection would cause the vehicle's brake performance to deteriorate and

could lead to an accident.

If your trailer's total weight (trailer weight plus its cargo weight) exceeds 1,000 lbs (453 kg), the trailer is required to be equipped with its own brake system. Electric brakes or surge brakes are recommended, and must be installed properly. Check that your trailer's brakes conform with Federal, state/province and/or other applicable regulations. Your SUBARU's brake system is not designed to be tapped into the trailer's hydraulic brake system. Please ask your SUBARU dealer and professional trailer supplier for more information about the trailer's brake system.

▼ **Trailer safety chains**

 **WARNING**

Always use safety chains between your vehicle and the trailer. Towing trailer without safety chains could create a traffic safety hazard if the trailer separates from the hitch due to coupling damage or hitch ball damage.

In case the trailer hitch connector or hitch ball should break or become disconnected, the trailer could get loose and

create a traffic safety hazard.

For safety, always connect the towing vehicle and trailer with trailer safety chains. Pass the chains crossing each other under the trailer tongue to prevent the trailer from dropping onto the ground in case the trailer tongue should disconnect from the hitch ball. Allow sufficient slack in the chains taking tight-turn situations into account; however, be careful not to let them drag on the ground.

For more information about the safety chain connection, refer to the instructions for your hitch and trailer.

▼ **Side mirrors**

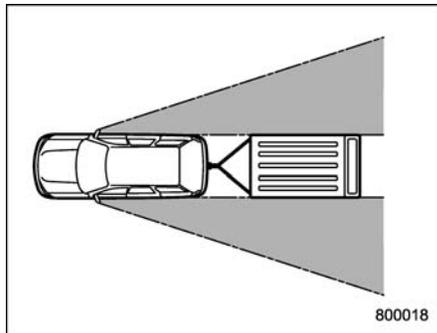

After hitching a trailer to your vehicle, check that the standard side mirrors provide a good rearward field of view

without significant blind spots. If significant blind spots occur with the vehicle's standard side mirrors, use towing mirrors that conform with Federal, state/province and/or other applicable regulations.

▼ **Trailer lights**

CAUTION

Direct splicing or other improper connection of trailer lights may damage your vehicle's electrical system and cause a malfunction of your vehicle's lighting system.

Connection of trailer lights to your vehicle's electrical system requires modifications to the vehicle's lighting circuit to increase its capacity and accommodate wiring changes. To ensure the trailer lights are connected properly, please consult your SUBARU dealer. Check for proper operation of the turn signals, the brake lights and parking lights each time you hitch up.

▼ **Tires**

WARNING

Never tow a trailer when the temporary spare tire is used. The temporary spare tire is not designed to

sustain the towing load. Use of the temporary spare tire when towing can result in failure of the spare tire and/or less stability of the vehicle.

Make sure that all the tires on your vehicle are properly inflated.

The recommended cold tire pressure under trailer towing conditions is shown in chapter 12, "Specifications" and in "GAS STATION REFERENCE" at the end of this manual. Adjust the rear tire pressure to the recommended pressure when the tires are cold. Normal pressure should be maintained in the front tires.

Trailer tire condition, size, load rating and proper inflation pressure should be in accordance with the trailer manufacturer's specifications.

In the event your vehicle gets a flat tire when towing a trailer, ask a commercial road service to repair the flat tire.

If you carry a regular size spare tire in your vehicle or trailer as a precaution against getting a flat tire, be sure that the spare tire is firmly secured.

■ Trailer towing tips

⚠ CAUTION

- Never exceed 45 mph (72 km/h) when towing a trailer in hilly country on hot days.
- When towing a trailer, steering, stability, stopping distance and braking performance will be different from normal operation. For safety's sake, you should employ extra caution when towing a trailer and you should never speed. You should also keep the following tips in mind:

▼ Before starting out on a trip

- Check that the vehicle and vehicle-to-hitch mounting are in good condition. If any problems are apparent, do not tow the trailer.
- Check that the vehicle sits horizontally with the trailer attached. If the vehicle is tipped sharply up at the front and down at the rear, check the total trailer weight, GVW, GAWs and tongue load again, then confirm that the load and its distribution are acceptable.
- Check that the tire pressures are correct.

- Check that the vehicle and trailer are connected properly. Confirm that
 - the trailer tongue is connected properly to the hitch ball.
 - the trailer lights connector is connected properly and trailer's brake lights illuminate when the vehicle's brake pedal is pressed, and that the trailer's turn signal lights flash when the vehicle's turn signal lever is operated.
 - the safety chains are connected properly.
 - all cargo in the trailer is secured safely in position.
 - the side mirrors provide a good rearward field of view without a significant blind spot.

- Sufficient time should be taken to learn the "feel" of the vehicle/trailer combination before starting out on a trip. In an area free of traffic, practice turning, stopping and backing up.

▼ Driving with a trailer

- You should allow for considerably more stopping distance when towing a trailer. Avoid sudden braking because it may result in skidding or jackknifing and loss of control.
- Avoid uneven steering, sharp turns and rapid lane changes.

- Slow down before turning. Make a longer than normal turning radius because the trailer wheels will be closer than the vehicle wheels to the inside of the turn. In a tight turn, the trailer could hit your vehicle.
- Crosswinds will adversely affect the handling of your vehicle and trailer, causing sway. Crosswinds can be due to weather conditions or the passing of large trucks or buses. If swaying occurs, firmly grip the steering wheel and slow down immediately but gradually.
- When passing other vehicles, considerable distance is required because of the added weight and length caused by attaching the trailer to your vehicle.

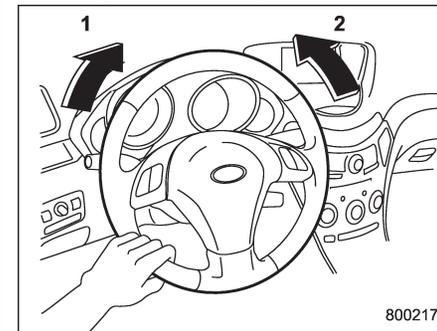

- 1) Left turn
- 2) Right turn

- Backing up with a trailer is difficult and takes practice. When backing up with a trailer, never accelerate or steer rapidly. When turning back, grip the bottom of the steering wheel with one hand and turn it to the left for a left turn, and turn it to the right for a right turn.

- If the ABS warning light illuminates while the vehicle is in motion, stop towing the trailer and have repairs performed immediately by the nearest SUBARU dealer.

▼ Driving on grades

- Before going down a steep hill, slow down and shift into lower gear (if necessary, use 1st gear) in order to utilize the engine braking effect and prevent overheating of your vehicle's brakes. Do not make sudden downshifts.

- When driving uphill in hot weather, the air conditioner may turn off automatically to protect the engine from overheating.

- When driving uphill in hot weather, pay attention to the water temperature gauge pointer and AT OIL TEMP warning light since the engine and transmission are relatively prone to overheating under these conditions. If the water temperature gauge pointer approaches the OVERHEAT zone or the AT OIL TEMP warning light illuminates, immediately switch off the

air conditioner and stop the vehicle at the nearest safe place. Refer to the "Engine overheating" section in chapter 9, and "Warning and indicator lights" section in chapter 3.

NOTE

The temperature of engine coolant is less likely to rise to the OVERHEAT zone in the "D" position than in the manual mode position.

- Avoid using the accelerator pedal to stay stationary on an uphill slope instead of using the parking brake or foot brake. That may cause the transmission fluid to overheat.

▼ Parking on a grade

Always block the wheels under both vehicle and trailer when parking. Apply the parking brake firmly. You should not park on a hill or slope. But if parking on a hill or slope cannot be avoided, you should take the following steps:

1. Apply the brakes and hold the pedal down.
2. Have someone place wheel blocks under both the vehicle and trailer wheels.
3. When the wheel blocks are in place, release the regular brakes slowly until the blocks absorb the load.
4. Apply the regular brakes and then

apply the parking brake; slowly release the regular brakes.

5. Shift into "P" and shut off the engine.

In case of emergency

If you park your vehicle in an emergency.....	9-2	Engine overheating	9-14
Spare tire	9-2	If steam is coming from the engine	
Removing the spare tire	9-3	compartment	9-14
Re-storage of spare tire	9-4	If no steam is coming from the engine	
Temporary spare tire.....	9-5	compartment	9-14
Flat tires.....	9-6	Towing	9-15
Changing a flat tire.....	9-6	Towing and tie-down hooks.....	9-15
Tire pressure monitoring system (TPMS)	9-11	Using a flat-bed truck.....	9-17
Jump starting	9-12	Towing with all wheels on the ground.....	9-18
How to jump start.....	9-12	Rear gate – if the rear gate cannot be	
		unlocked.....	9-18
		Maintenance tools	9-19
		Jack and jack handle	9-19

9-2 In case of emergency

If you park your vehicle in an emergency

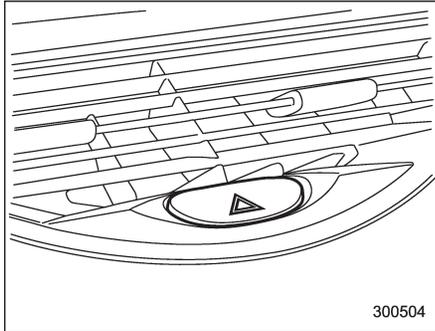

The hazard warning flasher should be used in day or night to warn other drivers when you have to park your vehicle under emergency conditions.

Avoid stopping on the road. It is best to safely pull off the road if a problem occurs.

The hazard warning flasher can be activated regardless of the ignition switch position.

Turn on the hazard warning by pushing the hazard warning flasher switch. Turn it off by pushing the switch again.

NOTE

When the hazard warning flasher is on, the turn signals do not work.

Spare tire

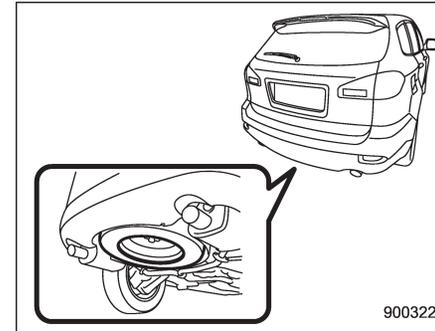

The spare tire is stored in the spare tire holder located under the cargo area.

The spare tire holder has a hoist mechanism that can lower and raise the spare tire easily.

The spare tire holder is designed to carry only the following kinds of tires:

- the temporary spare tire that came with your vehicle
- a full-size flat tire

A full size flat tire should be stowed in the spare tire holder in an emergency only. After having the full-size flat tire repaired, immediately swap it with the temporary spare tire.

Before using the temporary spare tire, see

the "Temporary spare tire" section in this chapter for instructions and precautions.

■ Removing the spare tire

1. Take the wheel nut wrench and extension out of the tool bag. Refer to the "Maintenance tools" section in this chapter.

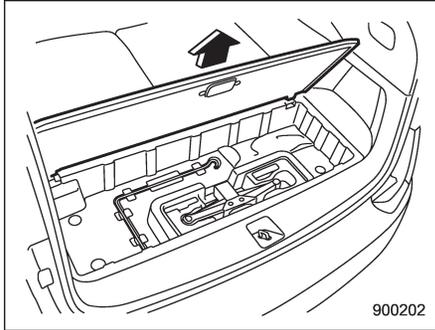

2. Remove the subfloor storage lid in the cargo area.
 3. Take out the jack.
 4. Locate the hex-head hoist shaft end inside the hole.

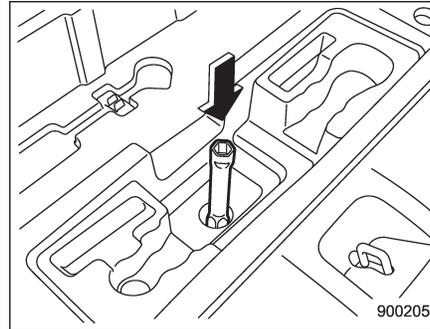

5. Fit the extension onto the hex-head hoist shaft end.

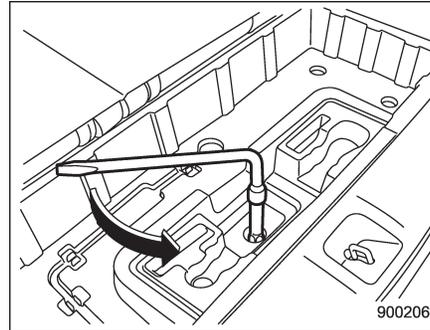

6. Fit the wheel nut wrench onto the extension.
 7. Turn the hoist shaft end counterclockwise with the wheel nut wrench until the

temporary spare tire is on the ground with enough cable slack to allow you to pull it out from under the vehicle.

⚠ CAUTION

- Be sure to remove (not simply keep it open) the subfloor storage lid before turning the wheel nut wrench, otherwise the lid may be damaged.
- Do not put your fingers into the center hole of the temporary spare tire while you pulling it out, because they might be pinched in between the wheel and the retainer.

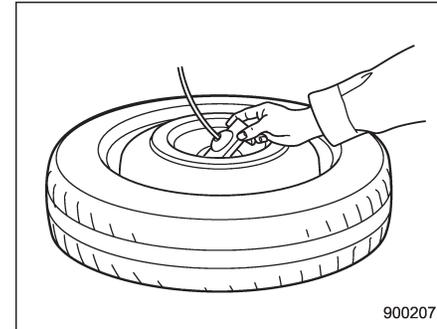

8. Tilt the retainer at the end of the cable

– CONTINUED –

9-4 In case of emergency

and pull it through the center of the temporary spare tire.

9. After the temporary spare tire is removed from the cable, the cable must be wound up completely by turning the hoist nut shaft clockwise until you hear a clicking sound. Also visually inspect the cable to make certain that there is no longer any slack present.

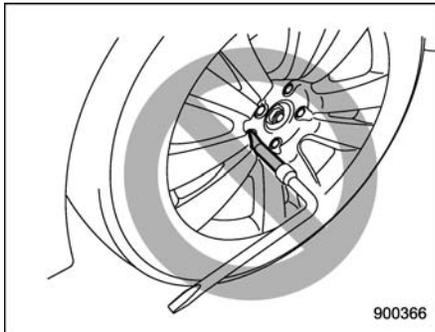

WARNING

- Do not use the extension when turning the wheel nuts. If you did, you would not be able to achieve sufficient tightening torque. The wheel nuts could then come loose, resulting in a serious accident.

- **When using the spare tire hoist:**

After the temporary spare tire is removed from the cable, wind the cable up completely until the retainer at end of the cable sits against the underside of the vehicle. Driving with the cable not retracted fully could result in damage to the adjacent under floor parts and lead to a serious accident.

- The spare tire holder is designed to carry only the following kinds of tires:

- the temporary spare tire that came with your vehicle
- a full-size flat tire

A full size flat tire should be stowed in the spare tire holder in an emergency only. After having the full-size flat tire repaired, immediately swap it with the temporary spare tire.

Never stow a full-size tire that is not flat in the spare tire holder. Doing so can result in damage to adjacent under floor parts and can lead to a serious accident.

CAUTION

When using the spare tire hoist:

Do not use air tools or power tools to turn the spare tire hoist shaft end. If you do, it could result in severe mechanical damage to the spare tire hoist.

Re-storage of spare tire

1. Turn the spare tire hoist shaft end counterclockwise with the wheel nut wrench to loosen the cable sufficiently enough to allow the cable end retainer go through center hole of the temporary spare tire.

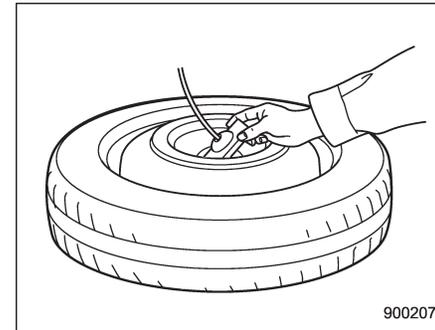

2. Insert the retainer through the center hole of the temporary tire (with the outside

of the tire facing up).

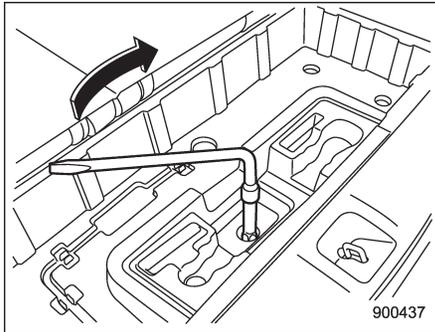

3. Turn the hoist shaft end clockwise with the wheel nut wrench to wind the cable up completely until you hear a few clicking sounds. Confirm that the temporary spare tire holding cable has been wound up completely by shaking the temporary tire.

CAUTION

If the temporary spare tire is not stored securely, it could damage adjacent areas of the vehicle and make an abnormal noise.

4. Place the wheel nut wrench and extension back into the tool bag and store the jack and tool bag in their storage locations.

5. Fit the lid of the cargo area.

CAUTION

- When stowing a flat tire in the spare tire holder, turn the hoist shaft end only slowly. If it is turned quickly, the wheel disc of the flat tire could be damaged.
- A full-size flat tire should be stowed in the spare tire holder in an emergency only. After having the flat tire repaired, immediately swap it with the temporary spare tire.
- Remember that the tread width of a flat tire is wider than that of the temporary spare tire. When carrying a flat tire stowed in the spare tire holder, make sure the tire does not touch any obstacles.

Temporary spare tire

WARNING

- Never tow a trailer when the temporary spare tire is used. The temporary spare tire is not designed to sustain the towing load. Use of the temporary spare tire when towing can result in failure of the spare tire and/or less stability of the vehicle and may lead to an accident.
- When a spare tire is mounted or a wheel rim is replaced without the original pressure sensor/transmitter being transferred, the low tire pressure warning light will illuminate steadily after blinking for approximately one minute. This indicates the tire pressure monitoring system (TPMS) is unable to monitor all four road wheels. Contact your SUBARU dealer as soon as possible for tire and sensor replacement and/or system resetting.

– CONTINUED –

CAUTION

Never use any temporary spare tire other than the original. Using other sizes may result in severe mechanical damage to the drive train of your vehicle.

The temporary spare tire is smaller and lighter than a conventional tire and is designed for emergency use only. Remove the temporary spare tire and re-install the conventional tire as soon as possible because the spare tire is designed only for temporary use.

Check the inflation pressure of the temporary spare tire periodically to keep the tire ready for use. The correct pressure is **60 psi (420 kPa, 4.2 kgf/cm²)**.

When using the temporary spare tire, note the following.

- Do not exceed 50 mph (80 km/h).
- Do not put a tire chain on the temporary spare tire. Because of the smaller tire size, a tire chain will not fit properly.
- Do not use two or more temporary spare tires at the same time.
- Do not drive over obstacles. This tire has a smaller diameter, so road clearance is reduced.

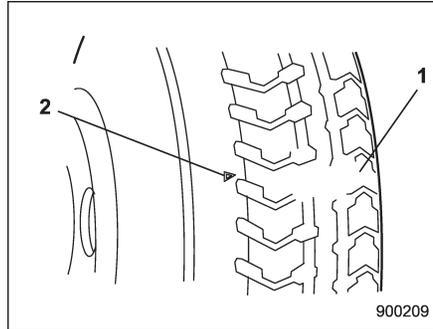

- 1) Tread wear indicator bar
- 2) Indicator location mark

- When the wear indicator appears on the tread, replace the tire.
- The temporary spare tire must be used only on a rear wheel. If a front wheel tire gets punctured, replace the wheel with a rear wheel and install the temporary spare tire in place of the removed rear wheel.

Flat tires

If you have a flat tire while driving, never brake suddenly; keep driving straight ahead while gradually reducing speed. Then slowly pull off the road to a safe place.

■ Changing a flat tire

WARNING

- Do not jack up the vehicle on an incline or a loose road surface. The jack can come out of the jacking point or sink into the ground and this can result in a severe accident.
- Use only the jack provided with your vehicle. The jack supplied with the vehicle is designed only for changing a tire. Never get under the vehicle while supporting the vehicle with this jack.

● Always turn off the engine before raising the flat tire off the ground using the jack. Never swing or push the vehicle supported with the jack. The jack can come out of the jacking point due to a jolt and this can result in a severe accident.

1. Park on a hard, level surface, whenever possible, then stop the engine.
2. Set the parking brake securely and shift in the "P" (Park) position.
3. Turn on the hazard warning flasher and have everyone get out of the vehicle.

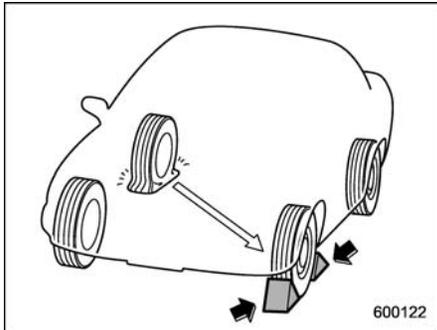

4. Put wheel blocks at the front and rear of the tire diagonally opposite the flat tire.

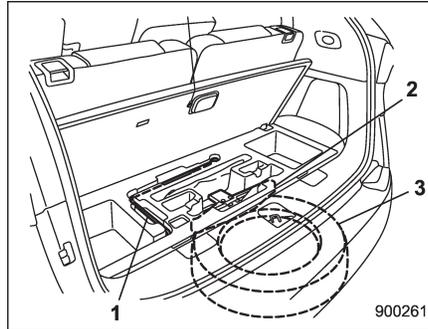

7-seater models

- 1) Jack handle
- 2) Jack
- 3) Spare tire

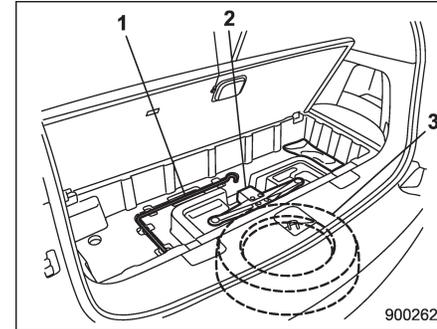

5-seater models

- 1) Jack handle
- 2) Jack
- 3) Spare tire

5. Take out the jack and jack handle. The jack and jack handle are stored under the floor of the cargo area.
6. Remove the spare tire. Refer to the sections "Spare tire" in this chapter for its location, instructions and precautions.

Carefully read the section "Temporary spare tire" in this chapter and strictly follow the instructions.

NOTE

Make sure the jack is well lubricated before using it.

9-8 *In case of emergency*

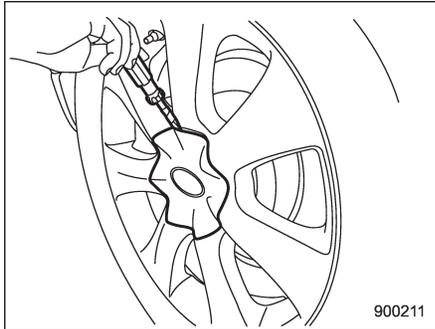

Chrome plated wheels

7. Insert the tip (wrapped in vinyl tape or a cloth) of a flat-head screwdriver into the slot between the wheel and cap. Use it to remove the cap. (Only vehicle equipped with chrome plated wheels)

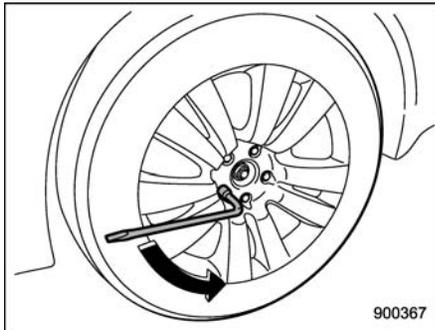

8. Loosen the wheel nuts using the wheel nut wrench but do not remove the nuts.

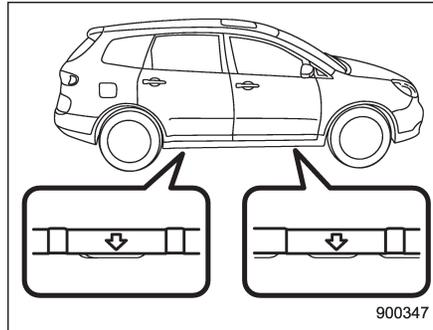

9. Place the jack under the side sill at the front or rear jack-up point closest to the flat tire.

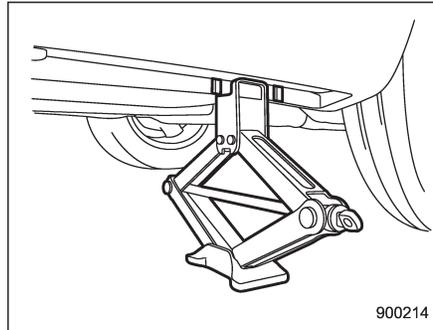

Turn the jackscrew by hand until the jack

head engages firmly into the jack-up point.

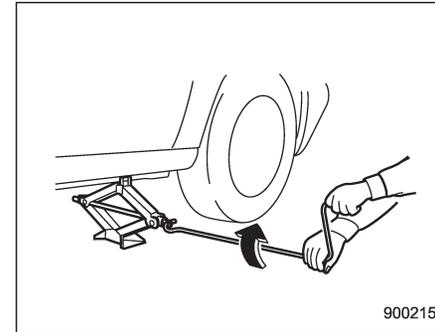

10. Insert the jack handle into the jackscrew, and turn the handle until the tire clears the ground. Do not raise the vehicle higher than necessary.

11. Remove the wheel nuts and the flat tire.

12. Remove the tire cover if the temporary spare tire has a cover.

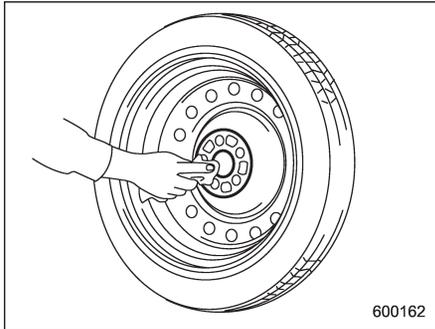
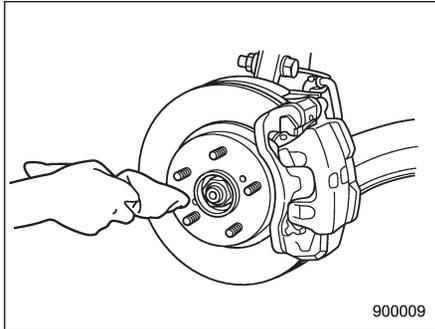

13. Before putting the spare tire on, clean the mounting surface of the wheel and hub with a cloth.

14. Put on the spare tire. Replace the wheel nuts. Tighten them by hand.

WARNING

Do not use oil or grease on the wheel studs or nuts when the spare tire is installed. This could cause the nuts to become loose and lead to an accident.

15. Turn the jack handle counterclockwise to lower the vehicle.

CAUTION

There are 2 types of wheel nut wrenches that apply to different lengths.

For an aluminum wheel vehicle, the 11.2-inch (285 mm) wheel nut wrench is equipped as a maintenance tool. And for a chrome plated wheel vehicle, the 13.2-inch (335 mm) wheel nut wrench is equipped as well. Confirm the equipped wheel nut wrench type when you replace a tire. If the wheel nut wrench is the different type, it cannot be tightened to the specified torque.

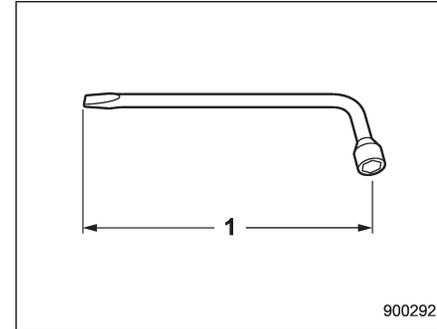

1) The length of the wheel nut wrench

16. Confirm the length of the equipped wheel nut wrench.

For an aluminum wheel vehicle, the 11.2-inch (285 mm) wheel nut wrench is equipped as a maintenance tool. And for a chrome plated wheel vehicle, the 13.2-inch (335 mm) wheel nut wrench is equipped as well.

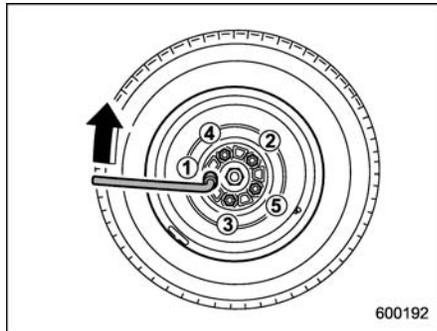

17. Use the wheel nut wrench to securely tighten the wheel nuts to the specified torque, following the tightening order in the illustration.

Wheel nuts tightening torque for temporary spare tire:
74 to 89 lbf-ft (100 to 120 N·m, 10 to 12 kgf·m)

This torque is equivalent to applying the following load on the edge of the wheel nut wrench.

When you use a wheel nut wrench of the 11.2-inch (285 mm) length:
Approximately 88 to 110 lbs (40 to 50 kg)

When you use a wheel nut wrench of the 13.2-inch (335 mm) length:

Approximately 73 to 87 lbs (33 to 38 kg)

Never use your foot on the wheel nut wrench or a pipe extension on the wrench because you may exceed the specified torque. Have the wheel nut torque checked at the nearest automotive service facility.

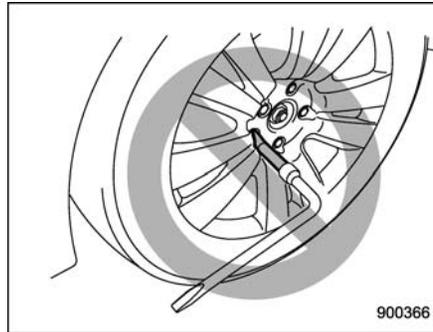

WARNING

Do not use the extension when turning the wheel nuts. If you did, you would not be able to achieve sufficient tightening torque. The wheel nuts could then come loose, resulting in a serious accident.

18. Store the flat tire in the spare tire holder.

Refer to the “Spare tire” section in this chapter for its location, instructions and precautions.

CAUTION

- When stowing a flat tire in the spare tire holder, turn the hoist shaft end only slowly. If it is turned quickly, the wheel disc of the flat tire could be damaged.
- A full-size flat tire should be stowed in the spare tire holder in an emergency only. After having the flat tire repaired, immediately swap it with the temporary spare tire.
- Remember that the tread width of a flat tire is wider than that of the temporary spare tire. When carrying a flat tire stowed in the spare tire holder, make sure the tire does not touch any obstacles.

WARNING

Never place a tire or tire changing tools in the passenger compartment after changing wheels. In a sudden stop or collisions, loose equipment

could strike occupants and cause injury. Store the tire and all tools in the proper place.

■ Tire pressure monitoring system (TPMS)

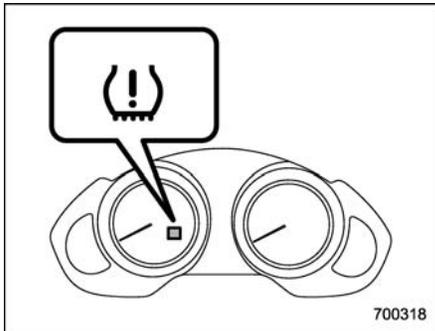

The tire pressure monitoring system provides the driver with the warning message indicated by sending a signal from a sensor that is installed in each wheel when tire pressure is severely low.

The tire pressure monitoring system will activate only when the vehicle is driven. Also, this system may not react immediately to a sudden drop in tire pressure (for example, a blow-out caused running over a sharp object).

⚠ WARNING

If the low tire pressure warning light illuminates while driving, never brake suddenly and keep driving straight ahead while gradually reducing speed. Then slowly pull off the road to a safe place. Otherwise an accident involving serious vehicle damage and serious personal injury could occur.

Check the pressure for all four tires and adjust the pressure to the COLD tire pressure shown on the vehicle placard on the door pillar on the driver's side. If this light still illuminates while driving after adjusting the tire pressure, a tire may have significant damage and a fast leak that causes the tire to lose air rapidly. If you have a flat tire, replace it with a spare tire as soon as possible.

When a spare tire is mounted or a wheel rim is replaced without the original pressure sensor/transmitter being transferred, the low tire pressure warning light will illuminate steadily after blinking for approximately one minute. This indicates the TPMS is unable to monitor all four road wheels. Contact your

SUBARU dealer as soon as possible for tire and sensor replacement and/or system resetting.

Do not inject any tire liquid or aerosol tire sealant into the tires, as this may cause a malfunction of the tire pressure sensors.

If the light illuminates steadily after blinking for approximately one minute, promptly contact a SUBARU dealer to have the system inspected.

Jump starting

 **WARNING**

- **Battery fluid is SULFURIC ACID. Do not let it come in contact with the eyes, skin, clothing or the vehicle.**
If battery fluid gets on you, thoroughly flush the exposed area with water immediately. Get medical help if the fluid has entered your eyes.
If battery fluid is accidentally swallowed, immediately drink a large amount of milk or water, and obtain immediate medical help.
Keep everyone including children away from the battery.
- The gas generated by a battery explodes if a flame or spark is brought near it. Do not smoke or light a match while jump starting.
- Never attempt jump starting if the discharged battery is frozen. It could cause the battery to burst or explode.
- Whenever working on or around a battery, always wear suitable

eye protectors, and remove metal objects such as rings, bands or other metal jewelry.

- Be sure the jumper cables and clamps on them do not have loose or missing insulation. Do not jump start unless cables in suitable condition are available.
- A running engine can be dangerous. Keep your fingers, hands, clothing, hair and tools away from the cooling fan, belts and any other moving engine parts. Removing rings, watches and ties is advisable.
- Jump starting is dangerous if it is done incorrectly. If you are unsure about the proper procedure for jump starting, consult a competent mechanic.

When your vehicle does not start due to a run down (discharged) battery, the vehicle may be jump started by connecting your battery to another battery (called the booster battery) with jumper cables.

■ How to jump start

1. Make sure the booster battery is 12 volts and the negative terminal is grounded.
2. If the booster battery is in another vehicle, do not let the two vehicles touch.
3. Turn off all unnecessary lights and accessories.
4. Connect the jumper cables exactly in the sequence illustrated.

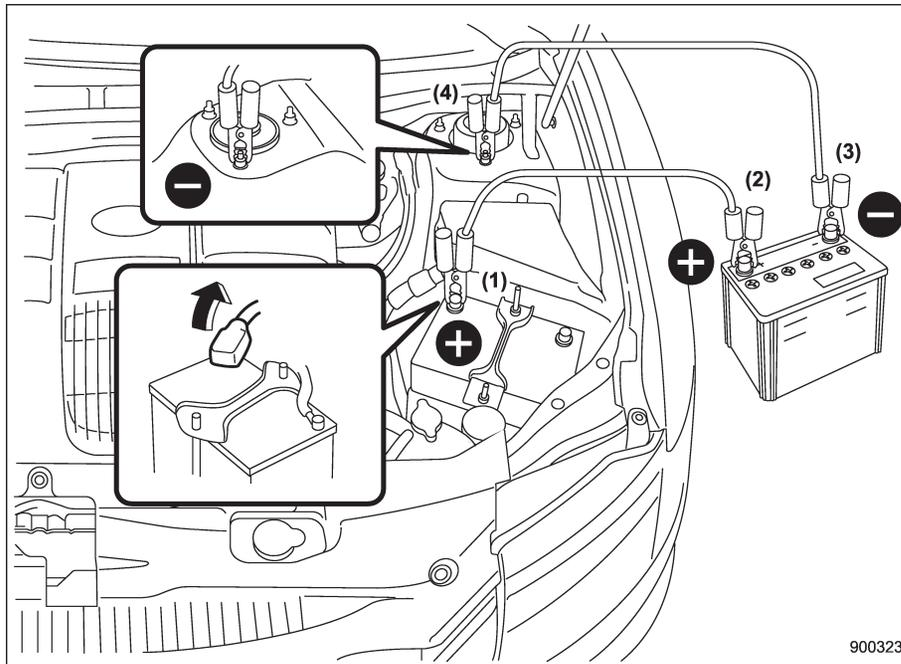

- (1) Connect one jumper cable to the positive (+) terminal on the discharged battery.
- (2) Connect the other end of the jumper cable to the positive (+) terminal of the booster battery.
- (3) Connect one end of the other cable to the negative (-) terminal of the booster battery.
- (4) Connect the other end of the cable to the strut mounting nut.

Make sure that the cables are not near any moving parts and that the cable clamps are not in contact with any other metal.

9-14 *In case of emergency*

5. Start the engine of the vehicle with the booster battery and run it at moderate speed. Then start the engine of the vehicle that has the discharged battery.
6. When finished, carefully disconnect the cables in exactly the reverse order.

Engine overheating

 **WARNING**

Never attempt to remove the radiator cap until the engine has been shut off and has fully cooled down. When the engine is hot, the coolant is under pressure. Removing the cap while the engine is still hot could release a spray of boiling hot coolant, which could burn you very seriously.

If the engine overheats, safely pull off the road and stop the vehicle in a safe place.

■ **If steam is coming from the engine compartment**

Turn off the engine and get everyone away from the vehicle until it cools down.

■ **If no steam is coming from the engine compartment**

1. Keep the engine running at idling speed.
2. Open the hood to ventilate the engine compartment.

Confirm that the cooling fan is turning. If the fan is not turning, immediately turn off

the engine and contact your authorized dealer for repair.

3. After the engine coolant temperature has dropped, turn off the engine.

If the temperature gauge stays at the overheated zone, turn off the engine.

4. After the engine has fully cooled down, check the coolant level in the reserve tank.

If the coolant level is below the "LOW" mark, add coolant up to the "FULL" mark.

5. If there is no coolant in the reserve tank, add coolant to the reserve tank. Then remove the radiator cap and fill the radiator with coolant.

If you remove the radiator cap from a hot radiator, first wrap a thick cloth around the radiator cap, then turn the cap counterclockwise slowly without pressing down until it stops. Release the pressure from the radiator. After the pressure has been fully released, remove the cap by pressing down and turning it.

Towing

WARNING

Never tow AWD vehicles with the front wheels raised off the ground while the rear wheels are on the ground, or with the rear wheels raised off the ground while the front wheels are on the ground. This will cause the vehicle to spin away due to the operation or deterioration of the center differential.

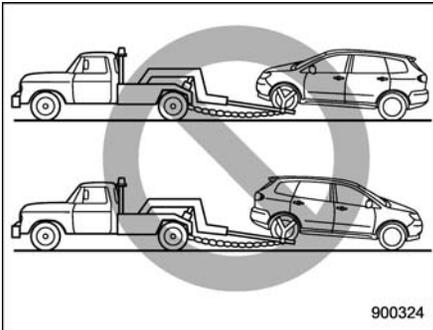

If towing is necessary, it is best done by your SUBARU dealer or a commercial towing service. Observe the following procedures for safety.

■ Towing and tie-down hooks

The towing hooks should be used only in an emergency (e.g., to free a stuck vehicle from mud, sand or snow).

CAUTION

- Use only the specified towing hooks and tie-down hooks. Never use suspension parts or other parts of the body for towing or tie-down purposes.
- Never use the tie-down hook closest to the muffler under the vehicle for towing purposes.
- To prevent deformation to the bumper and the towing hook, do not apply excessive lateral load to the towing hooks.

Front towing hook:

1. Take out the towing hook, screwdriver and wheel nut wrench from the tool bag.

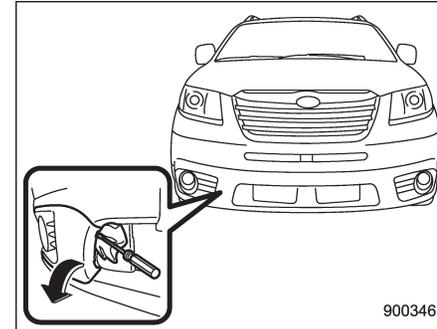

2. Wrap a flat-head screwdriver in vinyl tape or cloth, insert it into the gap between the cover and the front bumper, and use it to pry the cover open.

NOTE

- The cover is attached to the front bumper with five lugs.
- Do not remove the cover while holding the slit.

9-16 In case of emergency

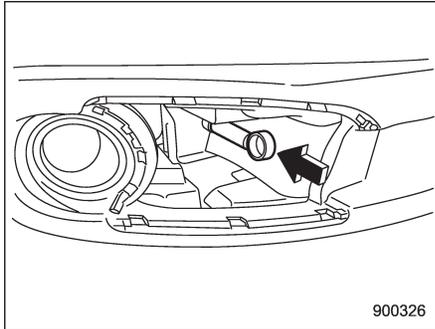

3. Screw the towing hook into the thread hole until the threads can no longer be seen.

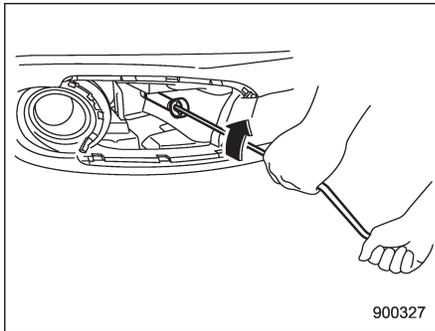

4. Tighten the towing hook securely using a jack handle.

After towing, remove the towing hook from the vehicle and stow it in the tool bag. Fit the towing hook cover on the bumper.

WARNING

- Do not use the towing hook except when towing your vehicle.
- Be sure to remove the towing hook after towing. Leaving the towing hook mounted on the vehicle could interfere with proper operation of the SRS airbag system in a frontal collision.

Rear towing hook:

1. Take out the towing hook, screwdriver and wheel nut wrench from the on board tool bag.

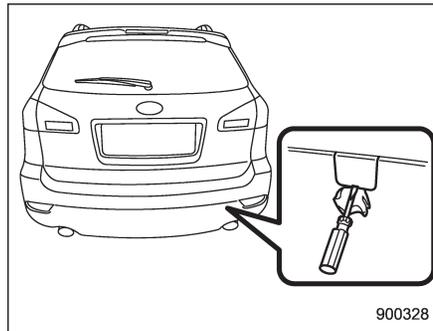

2. Pry off the cover on the rear bumper using a screwdriver, and you will find a threaded hole for attaching the towing hook.

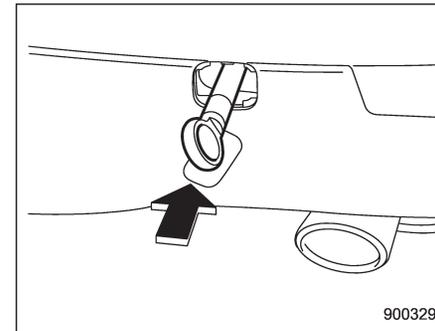

3. Screw the towing hook into the thread hole until its thread can no longer be seen.

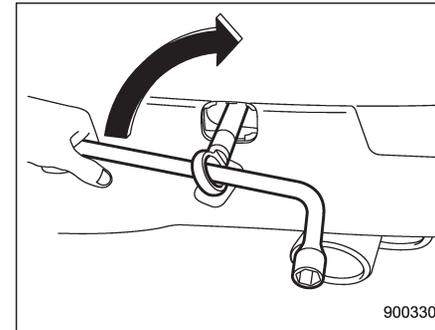

4. Tighten the towing hook securely using a wheel nut wrench.

After towing, remove the towing hook from the vehicle and stow it in the tool bag.

Put the thread hole cover on the rear bumper.

WARNING

- Do not use the towing hook except when towing your vehicle.
- Be sure to remove the towing hook after towing. Leaving the towing hook mounted on the vehicle could interfere with proper operation of the SRS airbag system in a frontal collision.

Front tie-down hooks:

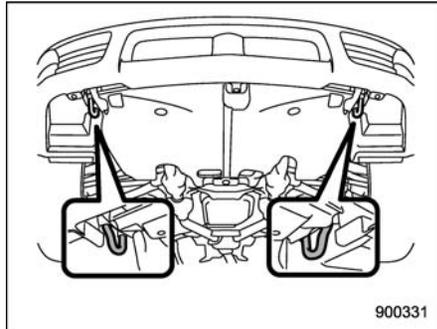

The front tie-down hooks are located between each of the front tires and the front bumper.

Rear tie-down hooks:

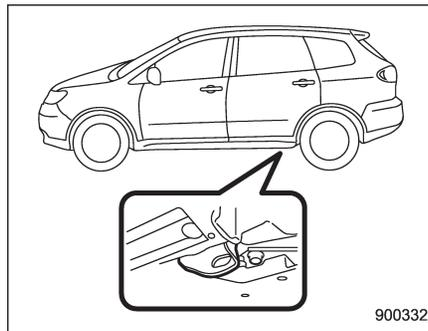

The rear tie-down hooks are located near each of the jack-up reinforcements.

WARNING

Use the rear tie-down hooks only for downward anchoring. If they are used to anchor the vehicle in any other direction, cables may slip off the hooks, possibly causing a dangerous situation.

Using a flat-bed truck

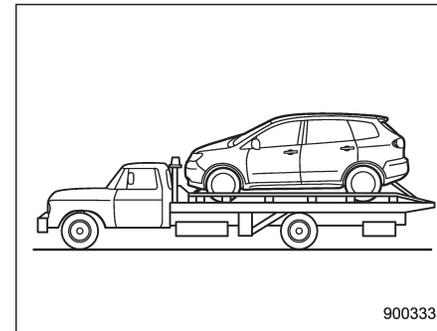

This is the best way to transport your vehicle. Use the following procedures to ensure safe transportation.

1. Shift the selector lever into the "P" position.
2. Press the parking brake pedal firmly.
3. Secure the vehicle onto the carrier properly with safety chains. Each safety chain should be equally tightened and care must be taken not to pull the chains so tightly that the suspension bottoms out.

■ Towing with all wheels on the ground

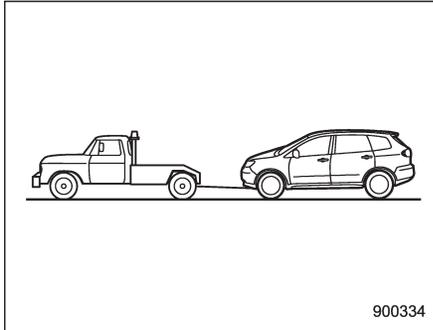

WARNING

- Never turn the ignition switch to the “LOCK” position while the vehicle is being towed because the steering wheel and the direction of the wheels will be locked.
- Remember that the brake booster and power steering do not function when the engine is not running. Because the engine is turned off, it will take greater effort to operate the brake pedal and steering wheel.

CAUTION

- If transmission failure occurs, transport your vehicle on a flat-bed truck.
- Do not run the engine while being towed using this method. Transmission damage could result if the vehicle is towed with the engine running.
- The traveling speed must be limited to less than 20 mph (30 km/h) and the traveling distance to less than 31 miles (50 km). For greater speeds and distances, transport your vehicle on a flat-bed truck.

1. Check the transmission and differential oil levels and add oil to bring it to the upper level if necessary.
2. Release the parking brake and put the transmission in neutral.
3. The ignition switch should be in the “Acc” position while the vehicle is being towed.
4. Take up slack in the towline slowly to prevent damage to the vehicle.

Rear gate – if the rear gate cannot be unlocked

In the event that you cannot unlock the rear gate by operating the power door locking switches or the remote keyless entry system, you can unlock it from inside the cargo area.

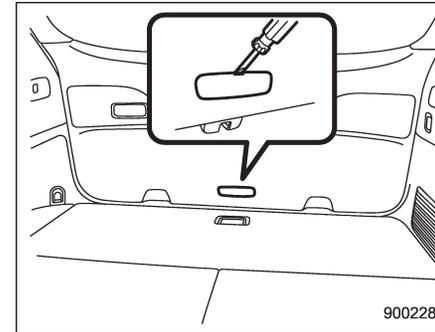

1. Remove the access cover at the bottom-center of the rear gate trim using flat-head screwdriver.
2. Locate the rear gate lock release lever behind the rear gate trim panel.

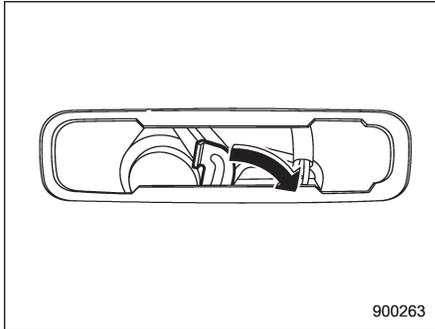

3. Unlock the rear gate by moving the lever to the right.
4. Open the rear gate from outside by raising the rear gate handle.

Maintenance tools

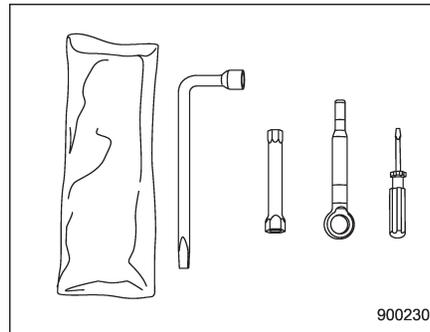

Your vehicle is equipped with the following maintenance tools:

- Screwdriver
- Towing hook (eye bolt)
- Wheel nut wrench
- Extension

■ Jack and jack handle

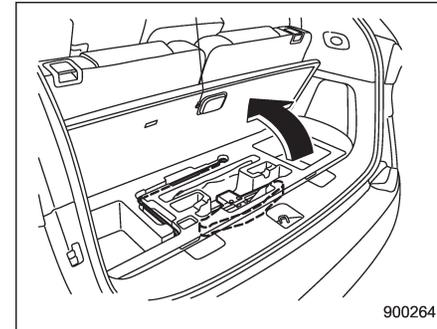

7-seater models

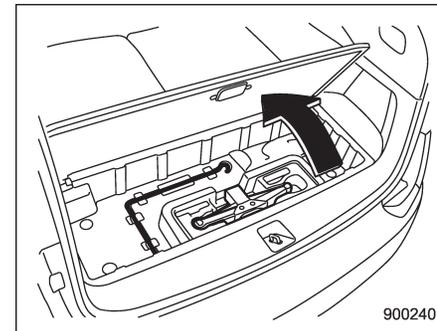

5-seater models

The jack and jack handle is stored under the cargo area.

9-20 *In case of emergency*

For how to use the jack, refer to the "Flat tires" section in this chapter.

Appearance care

Exterior care 10-2
 Washing..... 10-2
 Waxing and polishing..... 10-3
 Cleaning aluminum wheels 10-3
Corrosion protection..... 10-4
 Most common causes of corrosion 10-4
 To help prevent corrosion..... 10-4

Cleaning the interior 10-5
 Seat fabric 10-5
 Leather seat materials..... 10-5
 Synthetic leather upholstery..... 10-5
 Climate control panel, audio panel, instrument
 panel, console panel, switches, combination
 meter, and other plastic surface 10-5
 Navigation monitor (if equipped) 10-6

Exterior care

■ Washing

 **CAUTION**

- When washing the vehicle, the brakes may get wet. As a result, the brake stopping distance will be longer. To dry the brakes, drive the vehicle at a safe speed while lightly pressing the brake pedal to heat up the brakes.
- Do not wash the engine compartment and areas adjacent to it. If water enters the engine air intake, electrical parts or the power steering fluid reservoir, it will cause engine trouble or a malfunction of the power steering.

- Since your vehicle is equipped with a rear wiper, automatic car-wash brushes could become tangled around it, damaging the wiper arm and other components. Ask the automatic car-wash operator not to let the brushes touch the wiper arm or to fix the wiper arm on the rear window glass with adhesive tape before operating the machine.

NOTE

When having your vehicle washed in an automatic car wash, make sure beforehand that the car wash is of suitable type.

The best way to preserve your vehicle's beauty is frequent washing. Wash the vehicle at least once a month to avoid contamination by road grime.

Wash dirt off with a wet sponge and plenty of lukewarm or cold water. Do not wash the vehicle with hot water and in direct sunlight.

Salt, chemicals, insects, tar, soot, tree sap, and bird droppings should be washed off by using a light detergent, as required. If you use a light detergent, make certain that it is a neutral detergent. Do not use

strong soap or chemical detergents. All cleaning agents should be promptly flushed from the surface and not allowed to dry there. Rinse the vehicle thoroughly with plenty of lukewarm water. Wipe the remaining water off with a chamois or soft cloth.

▼ Washing the underbody

Chemicals, salts and gravel used for deicing road surfaces are extremely corrosive, accelerating the corrosion of underbody components, such as the exhaust system, fuel and brake lines, brake cables, floor pan and fenders, and suspension.

Thoroughly flush the underbody and inside of the fenders with lukewarm or cold water at frequent intervals to reduce the harmful effects of such agents.

Mud and sand adhering to the underbody components may accelerate their corrosion.

After driving off-road or muddy or sandy roads, wash the mud and sand off the underbody.

Carefully flush the suspension and axle parts, as they are particularly prone to mud and sand buildup. Do not use a sharp-edged tool to remove caked mud.

NOTE

Be careful not to damage brake hoses, sensor harnesses, and other parts when washing suspension components.

▼ Using a warm water washer

- Keep a good distance of 12 in (30 cm) or more between the washer nozzle and the vehicle.
- Do not wash the same area continuously.
- If a stain will not come out easily, wash by hand. Some warm water washers are of the high temperature, high pressure type, and they can damage or deform the resin parts such as mouldings, or cause water to leak into the vehicle.

■ Waxing and polishing

Always wash and dry the vehicle before waxing and polishing.

Use a good quality polish and wax and apply them according to the manufacturer's instructions. Wax or polish when the painted surface is cool.

Be sure to polish and wax the chrome trim, as well as the painted surfaces. Loss of wax on a painted surface leads to loss of the original luster and also quickens the deterioration of the surface. It is recom-

mended that a coat of wax be applied at least once a month, or whenever the surface no longer repels water.

If the appearance of the paint has diminished to the point where the luster or tone cannot be restored, lightly polish the surface with a fine-grained compound. Never polish just the affected area, but include the surrounding area as well. Always polish in only one direction. A No. 2000 grain compound is recommended. Never use a coarse-grained compound. Coarser grained compounds have a smaller grain-size number and could damage the paint. After polishing with a compound, coat with wax to restore the original luster. Frequent polishing with a compound or an incorrect polishing technique will result in removing the paint layer and exposing the undercoat. When in doubt, it is always best to contact your SUBARU dealer or an auto paint specialist.

NOTE

Be careful not to block the windshield washer nozzles with wax when waxing the vehicle.

■ Cleaning aluminum wheels

- Promptly wipe the aluminum wheels clean of any kind of grime or agent. If dirt is left on too long, it may be difficult to clean off.
- Do not use soap containing grit to clean the wheels. Be sure to use a neutral cleaning agent, and later rinse thoroughly with water. Do not clean the wheels with a stiff brush or expose them to a high-speed washing device.
- Clean the vehicle (including the aluminum wheels) with water as soon as possible when it has been splashed with sea water, exposed to sea breezes, or driven on roads treated with salt or other agents.

Corrosion protection

Your SUBARU has been designed and built to resist corrosion. Special materials and protective finishes have been used on most parts of the vehicle to help maintain fine appearance, strength, and reliable operation.

■ Most common causes of corrosion

The most common causes of corrosion are:

1. The accumulation of moisture retaining dirt and debris in body panel sections, cavities, and other areas.
2. Damage to paint and other protective coatings caused by gravel and stone chips or minor accidents.

Corrosion is accelerated on the vehicle when:

1. It is exposed to road salt or dust control chemicals, or used in coastal areas where there is more salt in the air, or in areas where there is considerable industrial pollution.
2. It is driven in areas of high humidity, especially when temperatures range just above freezing.
3. Dampness in certain parts of the vehicle remains for a long time, even

though other parts of the vehicle may be dry.

4. High temperatures will cause corrosion to parts of the vehicle which cannot dry quickly due to lack of proper ventilation.

■ To help prevent corrosion

Wash the vehicle regularly to prevent corrosion of the body and suspension components. Also, wash the vehicle promptly after driving on any of the following surfaces:

- roads that have been salted to prevent them from freezing in winter
- mud, sand, or gravel
- coastal roads

After the winter has ended, it is recommended that the underbody be given a very thorough washing.

Before the beginning of winter, check the condition of underbody components, such as the exhaust system, fuel and brake lines, brake cables, suspension, steering system, floor pan, and fenders. If any of them are found to be rusted, they should be given an appropriate rust prevention treatment or should be replaced. Contact your SUBARU dealer to perform this kind of maintenance and treatment if you need

assistance.

Repair chips and scratches in the paint as soon as you find them.

Check the interior of the vehicle for water and dirt accumulation under the floor mats because that could cause corrosion. Occasionally check under the mats to make sure the area is dry.

Keep your garage dry. Do not park your vehicle in a damp, poorly ventilated garage. In such a garage, corrosion can be caused by dampness. If you wash the vehicle in the garage or put the vehicle into the garage when wet or covered with snow, that can cause dampness.

If your vehicle is operated in cold weather and/or in areas where road salts and other corrosive materials are used, the door hinges and locks, and hood latch should be inspected and lubricated periodically.

Cleaning the interior

Use a soft, damp cloth to clean the climate control panel, audio equipment, instrument panel, center console, combination meter panel, and switches. (Do not use organic solvents.)

■ Seat fabric

Remove loose dirt, dust or debris with a vacuum cleaner. If the dirt is caked on the fabric or hard to remove with a vacuum cleaner, use a soft brush then vacuum it. Wipe the fabric surface with a tightly wrung cloth and dry the seat fabric thoroughly. If the fabric is still dirty, wipe using a solution of mild soap and lukewarm water then dry thoroughly.

If the stain does not come out, try a commercially-available fabric cleaner. Use the cleaner on a hidden place and make sure it does not affect the fabric adversely. Use the cleaner according to its instructions.

NOTE

When cleaning the seat, do not use benzene, paint thinner, or any similar materials.

■ Leather seat materials

The leather used by SUBARU is a high quality natural product which will retain its distinctive appearance and feel for many years with proper care.

Allowing dust or road dirt to build up on the surface can cause the material to become brittle and to wear prematurely. Regular cleaning with a soft, moist, natural fiber cloth should be performed monthly, taking care not to soak the leather or allow water to penetrate the stitched seams.

A mild detergent suitable for cleaning woolen fabrics may be used to remove difficult dirt spots, rubbing with a soft, dry cloth afterwards to restore the luster. If your SUBARU is to be parked for a long time in bright sunlight, it is recommended that the seats and headrests be covered, or the windows shaded, to prevent fading or shrinkage.

Minor surface blemishes or bald patches may be treated with a commercial leather spray lacquer. You will discover that each leather seat section will develop soft folds or wrinkles, which is characteristic of genuine leather.

■ Synthetic leather upholstery

The synthetic leather material used on the SUBARU may be cleaned using mild soap

or detergent and water, after first vacuuming or brushing away loose dirt. Allow the soap to soak in for a few minutes and wipe off with a clean, damp cloth. Commercial foam-type cleaners suitable for synthetic leather materials may be used when necessary.

NOTE

Strong cleaning agents such as solvents, paint thinners, window cleaner or gasoline must never be used on leather or synthetic interior materials.

■ Climate control panel, audio panel, instrument panel, console panel, switches, combination meter, and other plastic surface

Use a soft, damp cloth to clean the climate control panel, audio equipment, instrument panel, center console, combination meter panel, and switches.

NOTE

Do not use organic solvents such as paint thinners or gasoline, or strong cleaning agents that contain those solvents.

– CONTINUED –

■ **Navigation monitor (if equipped)**

To clean the navigation monitor, wipe it with a silicone cloth or with a soft cloth. If the navigation monitor is extremely dirty, clean it with a soft cloth moistened with neutral detergent then carefully wipe off any remaining detergent.

NOTE

- **Do not spray neutral detergent directly onto the monitor. Doing so could damage the monitor's components.**
- **Do not wipe the monitor with a hard cloth. Doing so could scratch the monitor.**
- **Do not use cleaning fluid that contains thinner, gasoline, or any other volatile substance. Such cleaning fluid could erase the lettering on the switches at the bottom of the monitor.**

Maintenance and service

Maintenance schedule	11-3	Recommended grade and viscosity	11-18
Maintenance precautions.....	11-3	Power steering fluid	11-19
Before checking or servicing in the engine compartment.....	11-4	Checking the fluid level.....	11-19
When you do checking or servicing in the engine compartment while the engine is running.....	11-4	Recommended fluid.....	11-20
Engine hood	11-4	Brake fluid.....	11-20
Engine compartment overview.....	11-6	Checking the fluid level.....	11-20
Engine oil.....	11-7	Recommended brake fluid	11-21
Checking the oil level	11-7	Brake booster	11-21
Changing the oil and oil filter.....	11-8	Brake pedal	11-21
Recommended grade and viscosity	11-9	Checking the brake pedal free play	11-21
Recommended grade and viscosity under severe driving conditions	11-10	Checking the brake pedal reserve distance.....	11-22
Cooling system	11-11	Replacement of brake pad and lining	11-22
Hose and connections.....	11-11	Breaking-in of new brake pads and linings	11-22
Engine coolant.....	11-11	Parking brake stroke	11-23
Air cleaner element.....	11-14	Tires and wheels.....	11-23
Replacing the air cleaner element.....	11-14	Types of tires.....	11-23
Spark plugs	11-15	Tire pressure monitoring system (TPMS).....	11-24
Recommended spark plugs	11-15	Tire inspection.....	11-25
Drive belts	11-15	Tire pressures and wear	11-25
Automatic transmission fluid	11-15	Wheel balance	11-27
Checking the fluid level	11-15	Wear indicators	11-28
Recommended fluid	11-16	Tire rotation direction mark.....	11-28
Front differential gear oil	11-17	Tire rotation.....	11-28
Checking the oil level	11-17	Tire replacement.....	11-29
Recommended grade and viscosity	11-17	Wheel replacement	11-29
Rear differential gear oil	11-18	Aluminum wheels	11-30
Checking the gear oil level	11-18	Chrome plated wheels (if equipped)	11-31
		Windshield washer fluid.....	11-32
		Replacement of wiper blades	11-33
		Windshield wiper blade assembly.....	11-33

Maintenance and service

Windshield wiper blade rubber	11-34	Front turn signal light (right-hand side)	11-45
Rear window wiper blade assembly	11-35	Front fog light.....	11-45
Rear window wiper blade rubber.....	11-35	Rear combination lights	11-46
Battery.....	11-37	Back-up light/Tail light	11-47
Fuses	11-38	Rear gate light.....	11-47
Main fuse	11-39	License plate light	11-47
Installation of accessories.....	11-40	Dome light.....	11-48
Replacing bulbs	11-41	Map light	11-49
Headlights (vehicles with HID headlights).....	11-42	Vanity mirror light.....	11-49
Headlights (vehicles without HID headlights).....	11-43	Door step light.....	11-50
Parking light (right-hand side).....	11-44	Cargo area light.....	11-50

Maintenance schedule

The scheduled maintenance items required to be serviced at regular intervals are shown in the "Warranty and Maintenance Booklet".

For details of your maintenance schedule, read the separate "Warranty and Maintenance Booklet".

Maintenance precautions

When maintenance and service are required, it is recommended that all work be done by an authorized SUBARU dealer.

If you perform maintenance and service by yourself, you should familiarize yourself with the information provided in this section on general maintenance and service for your SUBARU.

Incorrect or incomplete service could cause improper or unsafe vehicle operation. Any problems caused by improper maintenance and service performed by you are not eligible for warranty coverage.

WARNING

- Testing of an All-Wheel Drive vehicle must **NEVER** be performed on a single two-wheel dynamometer or similar apparatus. Attempting to do so will result in transmission damage and in uncontrolled vehicle movement and may cause an accident or injuries to persons nearby.
- Always select a safe area when performing maintenance on your vehicle.

- Always be very careful to avoid injury when working on the vehicle. Remember that some of the materials in the vehicle may be hazardous if improperly used or handled, for example, battery acid.
- Your vehicle should only be serviced by persons fully competent to do so. Serious personal injury may result to persons not experienced in servicing vehicles.
- Always use the proper tools and make certain that they are well maintained.
- Never get under the vehicle supported only by a jack. Always use a safety stands to support the vehicle.
- Never keep the engine running in a poorly ventilated area, such as a garage or other closed areas.
- Do not smoke or allow open flames around the fuel or battery. This will cause a fire.
- Because the fuel system is under pressure, replacement of the fuel filter should be performed only by your SUBARU dealer.
- Wear adequate eye protection to

– CONTINUED –

guard against getting oil or fluids in your eyes. If something does get in your eyes, thoroughly wash them out with clean water.

- Do not tamper with the wiring of the SRS airbag system or seatbelt pretensioner system, or attempt to take its connectors apart, as that may activate the system or it can render it inoperative. The wiring and connectors of these systems are yellow for easy identification. NEVER use a circuit tester for these wiring.

If your SRS airbag or seatbelt pretensioner needs service, consult your nearest SUBARU dealer.

■ Before checking or servicing in the engine compartment

WARNING

- Always stop the engine and set the parking brake firmly to prevent the vehicle from moving.
- Always let the engine cool down. Engine parts become very hot when the engine is running and

remain hot for some time after the engine is stopped.

- Do not spill engine oil, engine coolant, brake fluid or any other fluid on hot engine components. This may cause a fire.
- Always remove the key from the ignition switch. When the ignition switch is in the "ON" position, the cooling fan may operate suddenly even when the engine is stopped.

■ When you do checking or servicing in the engine compartment while the engine is running

WARNING

A running engine can be dangerous. Keep your fingers, hands, clothing, hair and tools away from the cooling fan, belts and any other moving engine parts. Removing rings, watches and ties is advisable.

Engine hood

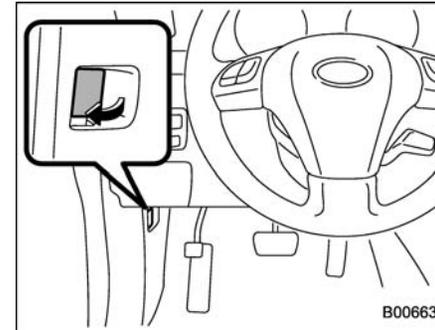

To open the hood:

1. If the wiper blades are lifted off the windshield, return them to their original positions.
2. Pull the hood release knob under the instrument panel.

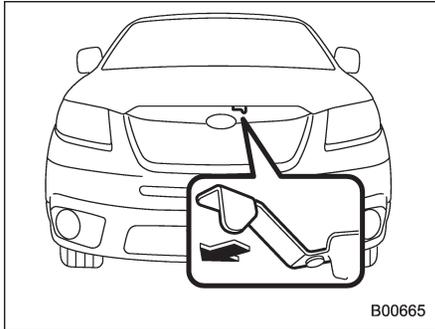

3. Release the secondary hood release located under the front grille by moving the lever toward the left.
4. Lift up the hood.

To close the hood:

1. Lower the hood to a point approximately 20 in (50 cm) from the closed position and then give the hood a strong push down to make it drop.
2. After closing the hood, be sure the hood is securely locked.

If this does not close the hood, release it from a slightly higher position. Do not push the hood forcibly to close it. It could deform the metal.

⚠ WARNING

Always check that the hood is properly locked before you start driving. If it is not, it might fly open while the vehicle is moving and block your view, which may cause an accident and serious bodily injury.

⚠ CAUTION

When closing the hood, be careful not to pinch your or other person's hands or anything else in the hood.

Engine compartment overview

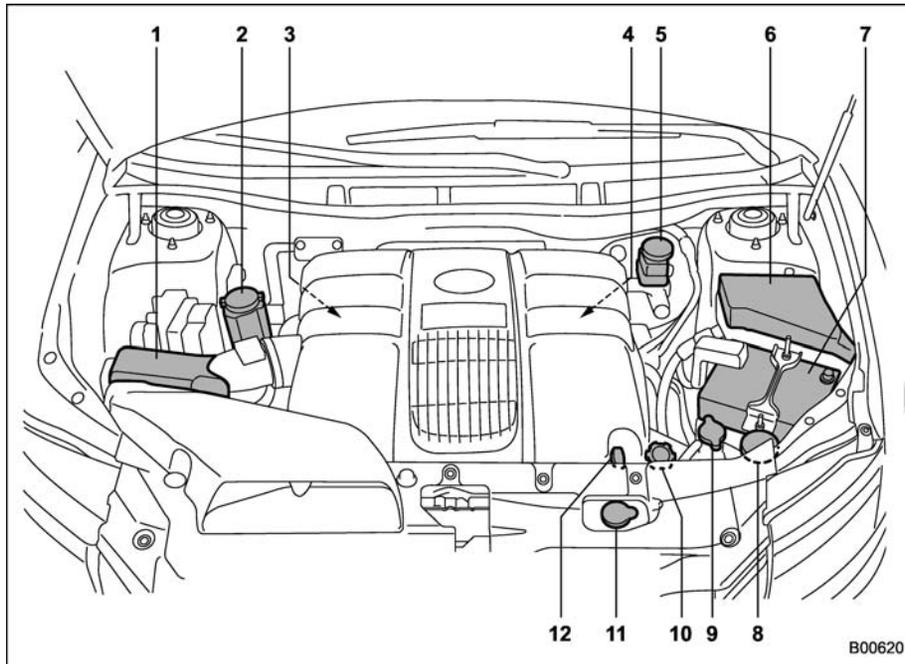

- 1) Air cleaner element (page 11-14)
- 2) Power steering fluid reservoir (page 11-19)
- 3) Differential gear oil level gauge (page 11-17)
- 4) Automatic transmission fluid level gauge (page 11-15)
- 5) Brake fluid reservoir (page 11-20)
- 6) Fuse box (page 11-38)
- 7) Battery (page 11-37)
- 8) Windshield washer tank (page 11-32)
- 9) Radiator cap (page 11-11)
- 10) Engine oil filler cap (page 11-7)
- 11) Engine coolant reservoir (page 11-11)
- 12) Engine oil level gauge (page 11-7)

Engine oil

NOTE

- The engine oil consumption rate is not stabilized, and therefore cannot be determined until the vehicle has traveled at least several thousand miles (kilometers). Even after break-in, when the vehicle is used under severe driving conditions such as those mentioned in the “Warranty and Maintenance Booklet”, engine oil is consumed or deteriorated more quickly than under normal driving conditions. If you drive your vehicle under these severe conditions, you should check the oil level at least at every second fuel fill-up time, and change the oil more frequently. Please refer to the “Warranty and Maintenance Booklet” for more details.
- If the oil consumption rate seems abnormally high after the break-in period, for example more than 1 quart per 1,200 miles or 1 liter per 2,000 kilometers, we recommend that you contact your SUBARU dealer.

■ Checking the oil level

Check the engine oil level at each fuel stop.

1. Park the vehicle on a level surface and stop the engine.

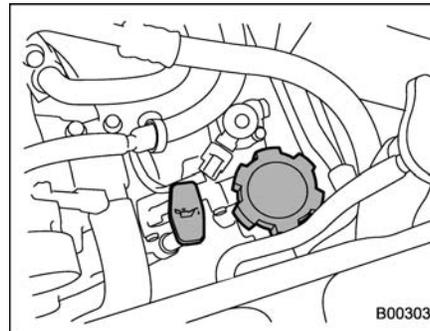

2. Pull out the level gauge, wipe it clean, and insert it again.
3. Be sure the level gauge is correctly inserted until it stops with the graphic symbol “” on its top appearing as shown in the illustration.

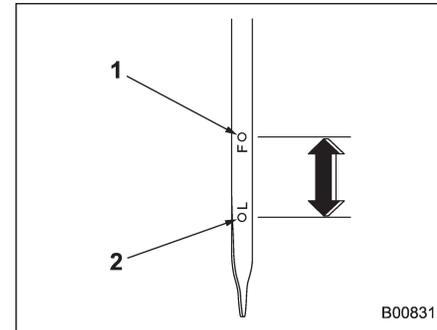

- 1) Upper level
- 2) Lower level

4. Pull out the level gauge again and check the oil level on it. If it is below the lower level, add oil to bring the level up to the upper level.

⚠ CAUTION

- Use only engine oil with the recommended grade and viscosity.

– CONTINUED –

11-8 Maintenance and service

- Be careful not to spill engine oil when adding it. If oil touches the exhaust pipe, it may cause a bad smell, smoke, and/or a fire. If engine oil gets on the exhaust pipe, be sure to wipe it off.

If you check the oil level just after stopping the engine, wait a few minutes for the oil to drain back into the oil pan before checking the level.

To prevent overfilling the engine oil, do not add any additional oil above the upper level when the engine is cold.

■ Changing the oil and oil filter

Change the oil and oil filter according to the maintenance schedule in the "Warranty and Maintenance Booklet".

The engine oil and oil filter must be changed more frequently than listed in the maintenance schedule when driving on dusty roads, when short trips are frequently made, or when driving in extremely cold weather.

1. Warm up the engine by letting the engine idle for approximately 10 minutes to ease draining the engine oil.
2. Park the vehicle on a level surface and stop the engine.
3. Remove the oil filler cap.

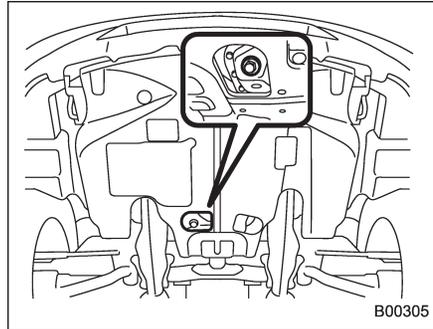

4. Drain out the engine oil by removing the drain plug while the engine is still warm. The used oil should be drained into an appropriate container and disposed of properly.

WARNING

Be careful not to burn yourself with hot engine oil.

5. Wipe the seating surface of the drain plug with a clean cloth and tighten it securely with a new sealing washer after the oil has completely drained out.

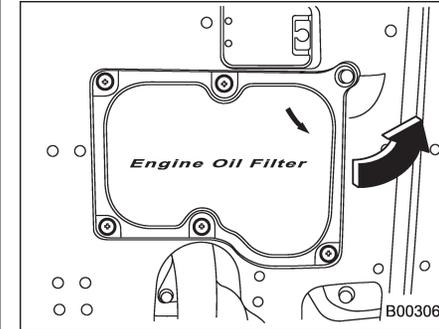

6. Open the access cover by removing the five clips and turning the access cover counterclockwise. The oil filter will be exposed.

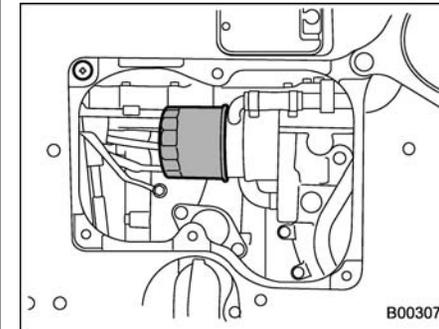

7. Remove the oil filter with an oil filter wrench.

8. Clean the rubber seal seating area of the bottom of engine and install the oil filter by hand turning. Be careful not to twist or damage the seal.

9. Tighten the oil filter by the amount indicated in the following table after the seal makes contact with the bottom of engine.

Oil filter color	Part number	Amount of rotation
Black	15208AA031	3/4 rotation

CAUTION

- **Never over tighten the oil filter because that can result in an oil leak.**
- **Thoroughly wipe off any engine oil that has spilled over the exhaust pipe and/or under-cover. If left unremoved, the oil could catch fire.**

10. Reinstall the cover under the oil filter.
11. Pour engine oil through the filler neck.

Oil capacity (guideline):
6.7 US qt (6.3 liters, 5.5 Imp qt)

The oil quantity indicated above is only a guideline. The necessary quantity of oil depends on the quantity of oil that has been drained. The quantity of drained oil differs slightly depending on the temperature of the oil and the time the oil is left flowing out. After refilling the engine with oil, therefore, you must use the level gauge to confirm that the level is correct.

12. Start the engine and make sure that no oil leaks appear around the filter's rubber seal and drain plug.

13. Run the engine until it reaches the normal operating temperature. Then stop the engine and wait a few minutes to allow the oil drain back. Check the oil level again and if necessary, add more engine oil.

Recommended grade and viscosity

CAUTION

Use only engine oil with the recommended grade and viscosity.

Oil grade:

ILSAC GF-4, which can be identified with the ILSAC certification mark (Starburst mark) or API classification SM with the words "ENERGY CONSERVING"

These recommended oil grades can be identified by looking for either or both of the following marks displayed on the oil container.



ILSAC Certification Mark (Starburst Mark)

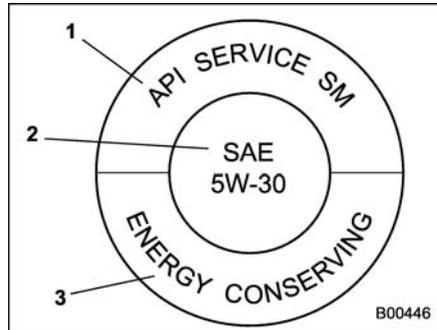

API Service label

- 1) Indicates the oil quality by API designations
- 2) Indicates the SAE oil viscosity grade
- 3) Indicates that the oil has fuel saving capabilities

In choosing an oil, you want the proper quality and viscosity, as well as one that will add to fuel economy. The following table lists the recommended viscosities and applicable temperatures.

When adding oil, different brands may be used together as long as they are the same API classification and SAE viscosity as those recommended by SUBARU.

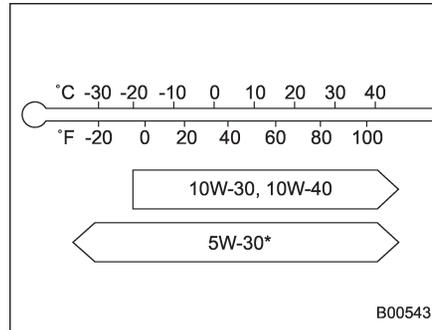

SAE viscosity number and applicable temperature

*: 5W-30 is recommended.

Engine oil viscosity (thickness) affects fuel economy. Oils of lower viscosity provide better fuel economy. However, in hot weather, oil of higher viscosity is required to properly lubricate the engine.

Recommended grade and viscosity under severe driving conditions

If the vehicle is used in desert areas, in areas with very high temperatures, or used for heavy-duty applications such as towing a trailer, use of oil with the following grade and viscosities is recommended.

API classification SM (or SL):

SAE viscosity No.:

30, 40, 10W-50, 20W-40, 20W-50

Cooling system

WARNING

Never attempt to remove the radiator cap until the engine has been shut off and has cooled down completely. Since the coolant is under pressure, you may suffer serious burns from a spray of boiling hot coolant when the cap is removed.

CAUTION

- Vehicles are filled at the factory with SUBARU Super Coolant that does not require the first change for 11 years/137,500 miles (11 years/220,000 km). This coolant should not be mixed with any other brand or type of coolant during this period. Mixing with a different coolant will reduce the life of the coolant. Should it be necessary to top off the coolant for any reason, use only SUBARU Super Coolant.

If the SUBARU Super Coolant is diluted with another brand or type, the maintenance interval is

shortened to that of the mixing coolant.

- Do not splash the engine coolant over painted parts. The alcohol contained in the engine coolant may damage the paint surface.

■ Hose and connections

Your vehicle employs an electric cooling fan which is thermostatically controlled to operate when the engine coolant reaches a specific temperature.

If the radiator cooling fan does not operate even when the engine coolant temperature gauge exceeds the normal operating range, the cooling fan circuit may be defective. Check the fuse and replace it if necessary. If the fuse is not blown, have the cooling system checked by your SUBARU dealer.

If frequent addition of coolant is necessary, there may be a leak in the engine cooling system. It is recommended that the cooling system and connections be checked for leaks, damage, or looseness.

■ Engine coolant

▼ Checking the coolant level

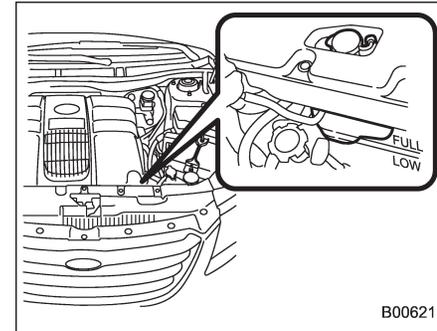

Check the coolant level at each fuel stop.

1. Check the coolant level on the outside of the reservoir while the engine is cool.
2. If the level is close to or lower than the "LOW" level mark, add coolant up to the "FULL" level mark. If the reserve tank is empty, remove the radiator cap and refill as required.

– CONTINUED –

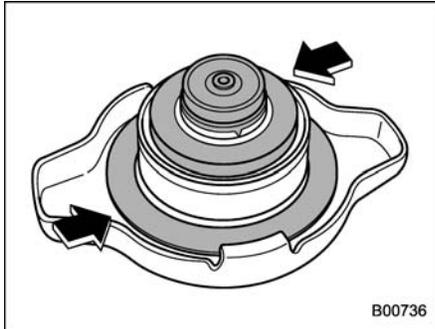

3. After refilling the reserve tank and the radiator, reinstall the caps and check that the rubber gaskets inside the radiator cap are in the proper position.

CAUTION

- Be careful not to spill engine coolant when adding it. If coolant touches the exhaust pipe, it may cause a bad smell, smoke, and/or a fire. If engine coolant gets on the exhaust pipe, be sure to wipe it off.

- Do not splash the engine coolant over painted parts. The alcohol contained in the engine coolant may damage the paint surface.

▼ Changing the coolant

Always add genuine SUBARU cooling system conditioner whenever the coolant is replaced.

Change the engine coolant and add genuine SUBARU cooling system conditioner using the following procedures according to the maintenance schedule in the "Warranty and Maintenance Booklet".

1. Remove the under cover.

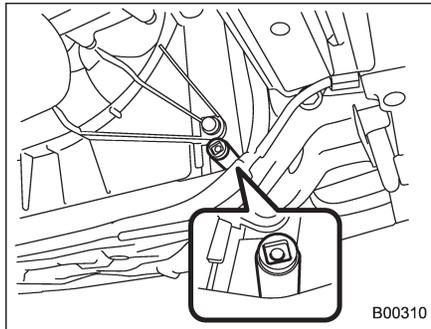

2. Place a proper container under the drain plug and loosen the drain plug.

3. Loosen the radiator cap to drain the coolant from the radiator. Then drain the coolant from the reserve tank. Tighten the drain plug securely.

WARNING

Never attempt to remove the radiator cap until the engine has been shut off and has cooled down completely. Since the coolant is under pressure, you may suffer serious burns from a spray of boiling hot coolant when the cap is removed.

4. Install the under cover.

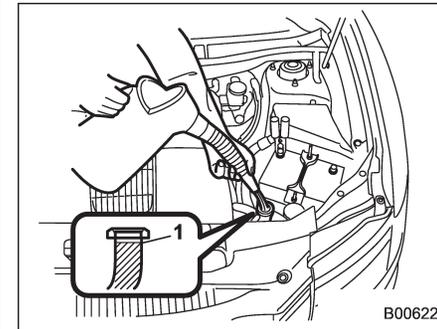

1) Fill up to here

5. Slowly pour the coolant and fill up to

just below the filler neck, allowing enough room to add genuine SUBARU cooling system conditioner in the radiator. Add genuine SUBARU cooling system conditioner until the coolant level reaches the filler neck. Do not pour the coolant too quickly, as this may lead to insufficient air bleeding and trapped air in the system.

Coolant capacity (guideline):
8.0 US qt (7.6 liters, 6.7 Imp qt)

CAUTION

- **Be careful not to spill engine coolant when adding it. If coolant touches the exhaust pipe, it may cause a bad smell, smoke, and/or a fire. If engine coolant gets on the exhaust pipe, be sure to wipe it off.**
- **Do not splash the engine coolant over painted parts. The alcohol contained in the engine coolant may damage the paint surface.**

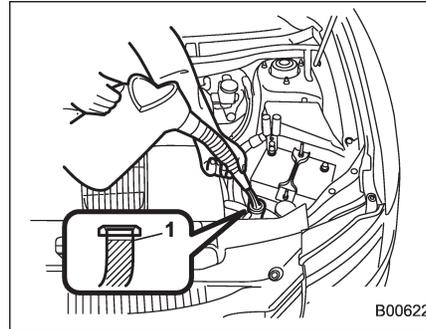

1) "FULL" level mark

6. Pour the coolant and fill to the reservoir tank's "FULL" level mark.

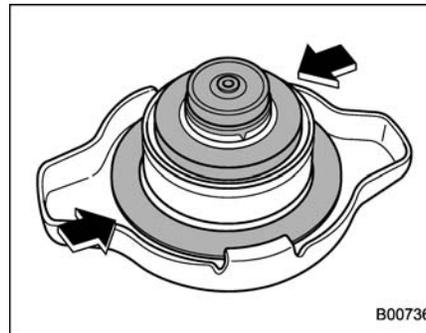

7. Put the radiator cap back on and tighten firmly. At this time, make sure that the rubber gasket in the radiator cap is

correctly in place.

8. Start and run the engine for more than 5 minutes at 2,000 to 3,000 rpm.

9. Stop the engine and wait until the coolant cools down (122 to 140°F [50 to 60°C]). If there is any loss of coolant, add coolant to the radiator's filler neck and to the reserve tank's "FULL" level.

10. Put the radiator cap and reservoir cap back on and tighten firmly.

Air cleaner element

⚠ WARNING

Do not operate the engine with the air cleaner element removed. The air cleaner element not only filters intake air but also stops flames if the engine backfires. If the air cleaner element is not installed when the engine backfires, you could be burned.

⚠ CAUTION

When replacing the air cleaner element, use a genuine SUBARU air cleaner element. If it is not used, there is the possibility of causing a negative effect to the engine.

The air cleaner element functions as a filter screen. When the element is perforated or removed, engine wear will be excessive and engine life shortened.

The air cleaner element is a dry type. It is unnecessary to clean or wash the element.

■ Replacing the air cleaner element

Replace the air cleaner element according to the maintenance schedule in the "Warranty and Maintenance Booklet". Under extremely dusty conditions, replace it more frequently. It is recommended that you always use genuine SUBARU parts.

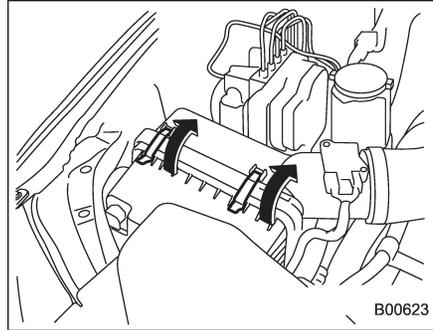

1. Unsnap the two clamps holding the air cleaner case cover.

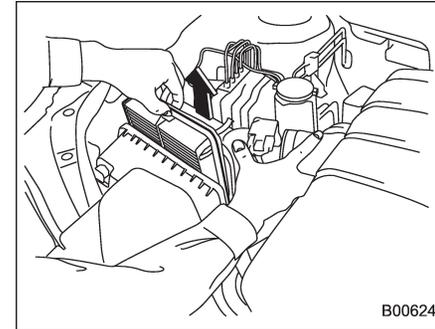

2. Open the air cleaner case cover and remove the air cleaner element.
3. Install a new air cleaner element.
4. To install the air cleaner case cover, snap the two clamps on the air cleaner case cover.

Spark plugs

It may be difficult to replace the spark plugs. It is recommended that you have the spark plugs replaced by your SUBARU dealer.

The spark plugs should be replaced according to the maintenance schedule in the "Warranty and Maintenance Booklet".

■ Recommended spark plugs

SILFR6A (NGK)

Drive belts

The alternator, power steering pump, and air conditioner compressor depend on drive belts. Satisfactory performance requires that belt tension be correct.

It is unnecessary to check belt tension periodically because your engine is equipped with an automatic belt tension adjuster. However, replacement of the belt should be done according to the maintenance schedule in the "Warranty and Maintenance Booklet". Consult your SUBARU dealer for replacement.

If a belt is loose, cracked, or worn, contact your SUBARU dealer.

Automatic transmission fluid

■ Checking the fluid level

The automatic transmission fluid expands largely as its temperature rises; the fluid level differs according to fluid temperature. Therefore, there are two different scales for checking the level of hot fluid and cold fluid on the level gauge.

Though the fluid level can be checked without warming up the fluid on the "COLD" range, we recommend checking the fluid level when the fluid is at operating temperature.

▼ Checking the fluid level when the fluid is hot

Check the fluid level monthly.

1. Drive the vehicle several miles to raise the temperature of the transmission fluid up to normal operating temperature; 158 to 176°F (70 to 80°C) is normal.
2. Park the vehicle on a level surface and set the parking brake.
3. First shift the selector lever in each position. Then shift it in the "P" position, and run the engine at idling speed.

– CONTINUED –

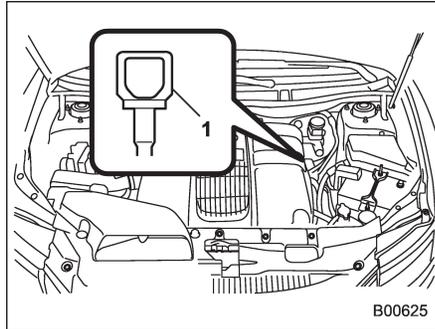

1) Yellow handle

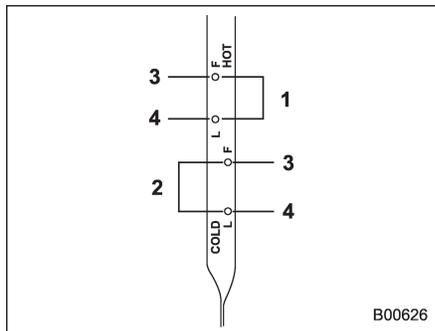

- 1) HOT range
- 2) COLD range
- 3) Upper level
- 4) Lower level

4. Pull out the level gauge and check the fluid level on the gauge. If it is below the lower level on the "HOT" range, add the recommended automatic transmission fluid up to the upper level.

▼ **Checking the fluid level when the fluid is cold**

When the fluid level has to be checked without time to warm up the automatic transmission, check to see that the fluid level is between the lower level and upper level on the "COLD" range. If it is below that range, add fluid up to the upper level. Be careful not to overfill.

CAUTION

Be careful not to spill automatic transmission fluid when adding it. If automatic transmission fluid touches the exhaust pipe, it may cause a bad smell, smoke, and/or a fire. If automatic transmission fluid gets on the exhaust pipe, be sure to wipe it off.

■ **Recommended fluid**

Use one of the following types of automatic transmission fluid.

- Genuine SUBARU Automatic Transmission Fluid Type-HP
- IDEMITSU ATF HP
- Castrol Transmax J

NOTE

Using any non-specified type of automatic transmission fluid could result in damage inside the transmission. When replacing the automatic transmission fluid, be sure to use a fluid of the types specified above.

Front differential gear oil

■ Checking the oil level

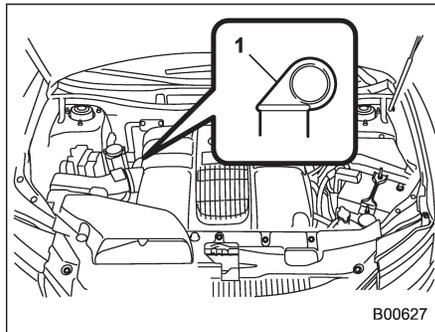

1) Yellow handle

1. Park the vehicle on a level surface and stop the engine.
2. Pull out the level gauge, wipe it clean, and insert it again.

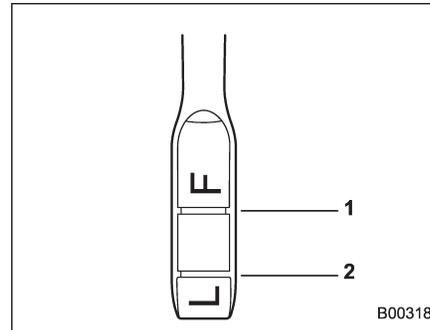

- 1) Upper level
- 2) Lower level

3. Pull out the level gauge again and check the oil level on it. If it is below the lower level, add oil to bring the level up to the upper level.

⚠ CAUTION

Be careful not to spill front differential gear oil when adding it. If oil touches the exhaust pipe, it may cause a bad smell, smoke, and/or a fire. If oil gets on the exhaust pipe, be sure to wipe it off.

■ Recommended grade and viscosity

Each oil manufacturer has its own base oils and additives. Never use different brands together.

Oil grade:

API classification GL-5

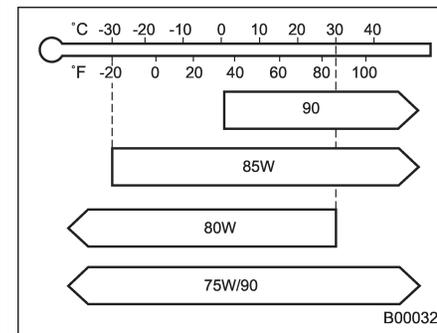

SAE viscosity No. and applicable temperature

Rear differential gear oil

■ Checking the gear oil level

Your vehicle may be equipped with a rear differential protector. The differential protector provides protection to the rear differential assembly during off-road use. Removal of the rear differential protector is not required when checking the oil level.

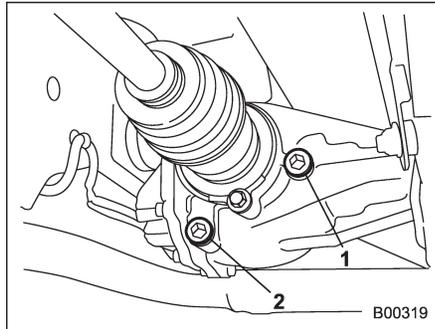

- 1) Filler plug
- 2) Drain plug

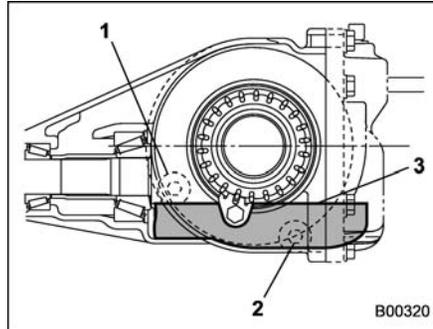

- 1) Filler hole
- 2) Drain hole
- 3) Oil level

Remove the plug from the filler hole and check the oil level. The oil level should be kept even with the bottom of the filler hole. If the oil level is below the bottom edge of the hole, add oil through the filler hole to raise the level.

⚠ CAUTION

- Be careful not to spill rear differential gear oil when adding it. If rear differential gear oil touches the exhaust pipe, it may cause a bad smell, smoke, and/or a fire. If rear differential gear oil gets on the exhaust pipe, be sure to wipe

it off.

- If the vehicle requires frequent refilling, there may be an oil leak. If you suspect a problem, have the vehicle checked at your SUBARU dealer.

■ Recommended grade and viscosity

Each oil manufacturer has its own base oils and additives. Never use different brands together.

Oil grade:

API classification GL-5

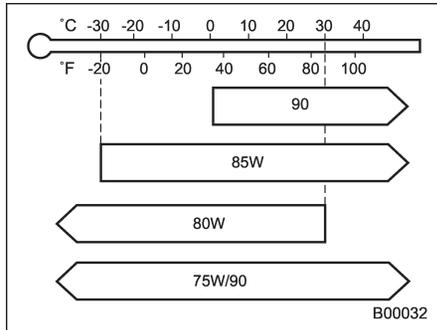

SAE viscosity No. and applicable temperature

Power steering fluid

■ Checking the fluid level

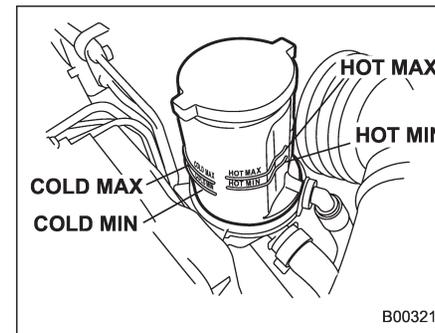

⚠ WARNING

Be careful not to burn yourself because the fluid may be hot.

⚠ CAUTION

- When power steering fluid is being added, use only clean fluid, and be careful not to allow any dirt into the tank. And never use different brands together.
- Avoid spilling fluid when adding it in the tank.

- Be careful not to spill power steering fluid when adding it. If power steering fluid touches the exhaust pipe, it may cause a bad smell, smoke, and/or a fire. If power steering fluid gets on the exhaust pipe, be sure to wipe it off.

The power steering fluid expands greatly as its temperature rises; the fluid level differs according to fluid temperature. Therefore, the reservoir tank has two different checking ranges for hot and cold fluids.

Check the power steering fluid level monthly.

1. Park the vehicle on a level surface, and stop the engine.
2. Check the fluid level of the reservoir tank.

When the fluid is hot after the vehicle has been run: Check that the oil level is between "HOT MIN" and "HOT MAX" on the surface of the reservoir tank.

When the fluid is cool before the vehicle is run: Check that the oil level is between "COLD MIN" and "COLD MAX" on the surface of the reservoir tank.

3. If the fluid level is lower than the applicable "MIN" line, add the recom-

- CONTINUED -

mended fluid as necessary to bring the level between the “MIN” and “MAX” line. If the fluid level is extreme low, it may indicate possible leakage. Consult your SUBARU dealer for inspection.

■ Recommended fluid

Use one of the following types of automatic transmission fluid.

Genuine SUBARU Automatic Transmission Fluid Type-HP

“Dexron III” Type Automatic Transmission Fluid

Brake fluid

■ Checking the fluid level

⚠ WARNING

- Never let brake fluid contact your eyes because brake fluid can be harmful to your eyes. If brake fluid gets in your eyes, immediately flush them thoroughly with clean water. For safety, when performing this work, wearing eye protection is advisable.
- Brake fluid absorbs moisture from the air. Any absorbed moisture can cause a dangerous loss of braking performance.
- If the vehicle requires frequent refilling, there may be a leak. If you suspect a problem, have the vehicle checked at your SUBARU dealer.

⚠ CAUTION

- Never use different brands of brake fluid together. Also, avoid mixing DOT 3 and DOT 4 brake fluids even if they are of the same brand.

- When adding brake fluid, be careful not to allow any dirt into the reservoir.
- Never splash the brake fluid over painted surfaces or rubber parts. Alcohol contained in the brake fluid may damage them.
- Be careful not to spill brake fluid when adding it. If brake fluid touches the exhaust pipe, it may cause a bad smell, smoke, and/or a fire. If brake fluid gets on the exhaust pipe, be sure to wipe it off.

Check the fluid level monthly.

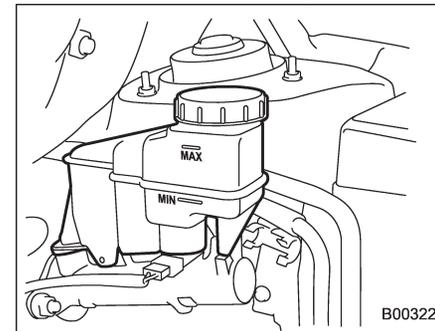

Check the fluid level on the outside of the reservoir. If the level is below “MIN”, add the recommended brake fluid to “MAX”.

Use only brake fluid from a sealed container.

■ Recommended brake fluid

FMVSS No. 116, fresh DOT 3 or 4 brake fluid

Brake booster

If the brake booster does not operate as described in the following, have it checked by your SUBARU dealer.

1. With the engine off, depress the brake pedal several times, applying the same pedal force each time. The distance the pedal travels should not vary.
2. With the brake pedal depressed, start the engine. The pedal should move slightly down to the floor.
3. With the brake pedal depressed, stop the engine and keep the pedal depressed for 30 seconds. The pedal height should not change.
4. Start the engine again and run for approximately 1 minute then turn it off. Depress the brake pedal several times to check the brake booster. The brake booster operates properly if the pedal stroke decreases with each depression.

Brake pedal

Check the brake pedal free play and reserve distance according to the maintenance schedule in the "Warranty and Maintenance Booklet".

■ Checking the brake pedal free play

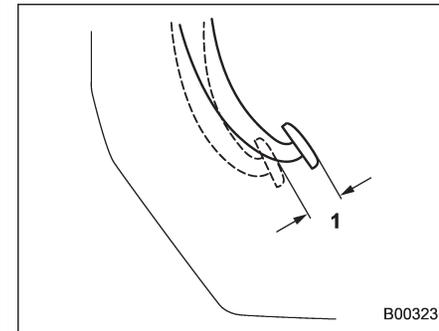

1) 0.02 – 0.08 in (0.5 – 2.0 mm)

Stop the engine and firmly depress the brake pedal several times. Lightly pull the brake pedal up with one finger to check the free play with a force of less than 2 lbf (10 N, 1 kgf).

If the free play is not within proper specification, contact your SUBARU dealer.

– CONTINUED –

■ Checking the brake pedal reserve distance

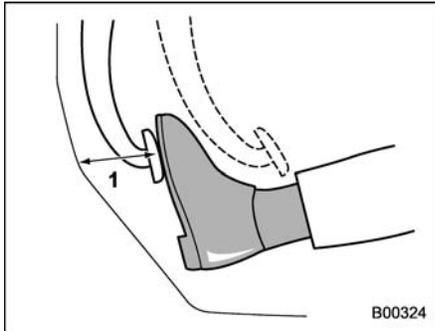

1) More than 2.16 in (55 mm)

Depress the pedal with a force of approximately 66 lbf (294 N, 30 kgf) and measure the distance between the upper surface of the pedal pad and the floor.

When the measurement is smaller than the specification, or when the pedal does not operate smoothly, contact with your SUBARU dealer.

Replacement of brake pad and lining

⚠ CAUTION

If you continue to drive despite the scraping noise from the audible brake pad wear indicator, it will result in the need for costly brake rotor repair or replacement.

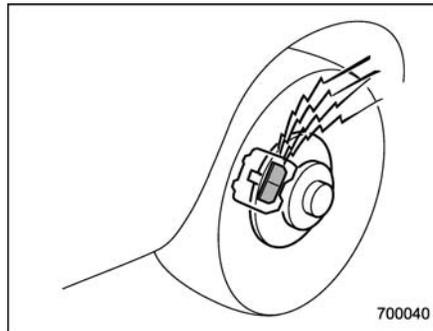

The front disc brake and the right rear disc brake have audible wear indicators on the brake pads. If the brake pads wear close to their service limit, the wear indicator makes a very audible scraping noise when the brake pedal is applied.

If you hear this scraping noise each time

you apply the brake pedal, have the brake pads serviced by your SUBARU dealer as soon as possible.

■ Breaking-in of new brake pads and linings

When replacing the brake pad or lining, use only genuine SUBARU parts. After replacement, the new parts must be broken in as follows:

▼ Brake pad and lining

While maintaining a speed of 30 to 40 mph (50 to 65 km/h), step on the brake pedal lightly. Repeat this five or more times.

▼ Parking brake lining

⚠ WARNING

A safe location and situation should be selected for break-in driving.

⚠ CAUTION

Pressing the parking brake pedal too forcefully may cause the rear wheels to lock. To avoid this, be certain to press the pedal slowly and gently.

1. Drive the vehicle at a speed of approximately 22 mph (35 km/h).
2. Depress the parking brake pedal SLOWLY and GENTLY. (Pressing with a force of approximately 34 lbf [150 N, 15 kgf].)
3. Drive the vehicle for approximately 220 yards (200 meters) in this condition.
4. Wait 5 to 10 minutes for the parking brake to cool down. Repeat this procedure.
5. Check the parking brake stroke. If the parking brake stroke is out of the specified range, adjust it by turning the adjusting nut located on the parking brake pedal.

Parking brake stroke:

5 – 6 notches / 67 lbf (300 N, 30 kgf)

Parking brake stroke

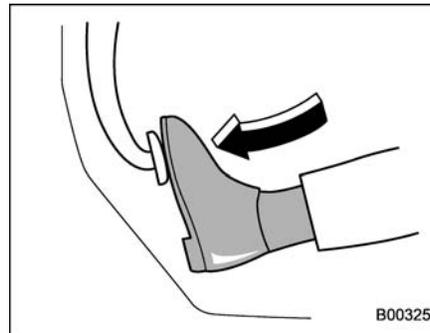

Check the parking brake stroke according to the maintenance schedule in the "Warranty and Maintenance Booklet". When the parking brake is properly adjusted, braking power is fully applied by depressing the pedal five to six notches gently but firmly (approximately 67 lbf, 300 N, 30 kgf). If the parking brake pedal stroke is not within the specified range, have the brake system checked and adjusted at your SUBARU dealer.

Tires and wheels

■ Types of tires

You should be familiar with type of tires present on your vehicle.

▼ All season tires

The factory-installed tires on your new vehicle are all season tires.

All season tires are designed to provide an adequate measure of traction, handling and braking performance in year-round driving including snowy and icy road conditions. However all season tires do not offer as much traction performance as winter (snow) tires in heavy or loose snow or on icy roads.

All season tires are identified by "ALL SEASON" and/or "M+S" (Mud & Snow) on the tire sidewall.

▼ Summer tires

Summer tires are high-speed capability tires best suited for highway driving under dry conditions.

Summer tires are inadequate for driving on slippery roads such as on snow-covered or icy roads.

If you drive your vehicle on snow-covered or icy roads, we strongly recommend the use of winter (snow) tires.

When installing winter tires, be sure to

– CONTINUED –

replace all four tires.

▼ **Winter (snow) tires**

Winter tires are best suited for driving on snow-covered and icy roads. However winter tires do not perform as well as summer tires and all season tires on roads other than snow-covered and icy roads.

■ **Tire pressure monitoring system (TPMS)**

The tire pressure monitoring system provides the driver with a warning message by sending a signal from a sensor that is installed in each wheel when tire pressure is severely low. The tire pressure monitoring system will activate only when the vehicle is driven. Also, this system may not react immediately to a sudden drop in tire pressure (for example, a blow-out caused by running over a sharp object).

If you adjust the tire pressures in a warm garage and will then drive the vehicle in cold outside air, the resulting drop in tire pressures may cause the low tire pressure warning light to illuminate. To avoid this problem when adjusting the tire pressures in a warm garage, inflate the tires to pressures higher than those shown on the tire placard. Specifically, inflate them by an extra 1 psi (6.9 kPa, 0.07 kgf/cm²) for every difference of 10°F (5.6°C) between

the temperature in the garage and the temperature outside. By way of example, the following table shows the required tire pressures that correspond to various outside temperatures when the temperature in the garage is 60°F (15.6°C).

Standard tire pressures:

Front: 33 psi (230 kPa, 2.3 kgf/cm²)

Rear: 32 psi (220 kPa, 2.2 kgf/cm²)

Garage temperature: 60°F (15.6°C)

Outside temperature	Adjusted pressure [psi (kPa, kgf/cm ²)]	
	front	rear
30°F (-1°C)	36 (250, 2.5)	35 (240, 2.4)
10°F (-12°C)	38 (265, 2.65)	37 (255, 2.55)
-10°F (-23°C)	40 (280, 2.8)	39 (270, 2.7)

If the low tire pressure warning light illuminates when you drive the vehicle in cold outside air after adjusting the tire pressures in a warm garage, re-adjust the tire pressures using the method described above. Then, increase the vehicle speed to at least 20 mph (32 km/h) and check to see that the low tire pressure warning light turns off a few minutes later. If the low tire pressure warning light does not turn off, the tire pressure monitoring system may

not be functioning normally. In this event, go to a SUBARU dealer to have the system inspected as soon as possible.

While the vehicle is driven, friction between tires and the road surface causes the tires to warm up. After illumination of the low tire pressure warning light, any increase in the tire pressures caused by an increase in the outside air temperature or by an increase in the temperature in the tires can cause the low tire pressure warning light to turn off.

System resetting is necessary when the wheels are changed (for example, a switch to snow tires) and new TPMS valves are installed on the newly fitted wheels. Have this work performed by a SUBARU dealer following wheel replacement.

It may not be possible to install TPMS valves on certain wheels that are on the market. Therefore, if you change the wheels (for example, a switch to snow tires), use wheels that have the same part number as the standard-equipment wheels. Without four operational TPMS valve/sensors on the wheels, the TPMS will not fully function and the warning light in the instrument panel will illuminate steadily after blinking for approximately one minute.

When a tire is replaced, adjustments are necessary to ensure continued normal operation of the tire pressure monitoring system. As with wheel replacement, therefore, you should have the work performed by a SUBARU dealer.



WARNING

If the low tire pressure warning light does not illuminate briefly after the ignition switch is turned ON or the light illuminates steadily after blinking for approximately one minute, you should have your Tire Pressure Monitoring System checked at a SUBARU dealer as soon as possible.

If this light illuminates while driving, never brake suddenly and keep driving straight ahead while gradually reducing speed. Then slowly pull off the road to a safe place. Otherwise an accident involving serious vehicle damage and serious personal injury could occur.

If this light still illuminates while driving after adjusting the tire pressure, a tire may have significant damage and a fast leak that causes the tire to lose air rapidly. If you have a flat tire, replace it with a spare tire

as soon as possible.

When a spare tire is mounted or a wheel rim is replaced without the original pressure sensor/transmitter being transferred, the low tire pressure warning light will illuminate steadily after blinking for approximately one minute. This indicates the TPMS is unable to monitor all four road wheels. Contact your SUBARU dealer as soon as possible for tire and sensor replacement and/or system resetting. If the light illuminates steadily after blinking for approximately one minute, promptly contact a SUBARU dealer to have the system inspected.

■ Tire inspection

Check on a daily basis that the tires are free from serious damage, nails, and stones. At the same time, check the tires for abnormal wear.

Contact your SUBARU dealer immediately if you find any problem.

NOTE

- When the wheels and tires strike curbs or are subjected to harsh treatment as when the vehicle is driven on a rough surface, they can suffer damage

that cannot be seen with the naked eye. This type of damage does not become evident until time has passed. Try not to drive over curbs, potholes or on other rough surfaces. If doing so is unavoidable, keep the vehicle's speed down to a walking pace or less, and approach the curbs as squarely as possible. Also, make sure the tires are not pressed against the curb when you park the vehicle.

- If you feel unusual vibration while driving or find it difficult to steer the vehicle in a straight line, one of the tires and/or wheels may be damaged. Drive slowly to the nearest authorized SUBARU dealer and have the vehicle inspected.

■ Tire pressures and wear

Maintaining the correct tire pressures helps to maximize the tires' service lives and is essential for good running performance. Check and, if necessary, adjust the pressure of each tire (including the spare) at least once a month (for example, during a fuel stop) and before any long journey.

– CONTINUED –

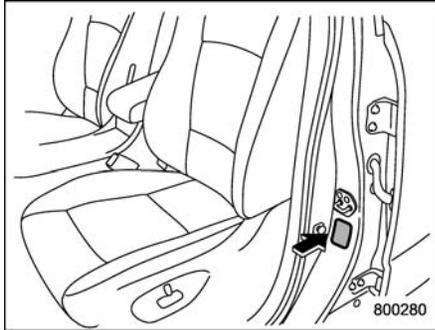

Check the tire pressures when the tires are cold. Use a pressure gauge to adjust the tire pressures to the values shown on the tire placard. The tire placard is located on the door pillar on the driver's side.

Driving even a short distance warms up the tires and increases the tire pressures. Also, the tire pressures are affected by the outside temperature. It is best to check tire pressure outdoors before driving the vehicle.

When a tire becomes warm, the air inside it expands, causing the tire pressure to increase. Be careful not to mistakenly release air from a warm tire to reduce its pressure.

NOTE

- The air pressure in a tire increases by approximately 4.3 psi (30 kPa, 0.3 kgf/cm²) when the tire becomes warm.
- The tires are considered cold when the vehicle has been parked for at least 3 hours or has been driven less than 1 mile (1.6 km).

WARNING

Do not let air out of warm tires to adjust pressure. Doing so will result in low tire pressure.

Incorrect tire pressures detract from controllability and ride comfort, and they cause the tires to wear abnormally.

- **Correct tire pressure** (tread worn evenly)

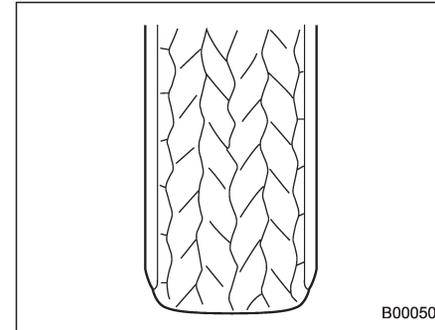

Roadholding is good, and steering is responsive. Rolling resistance is low, so fuel consumption is also lower.

- **Abnormally low tire pressure** (tread worn at shoulders)

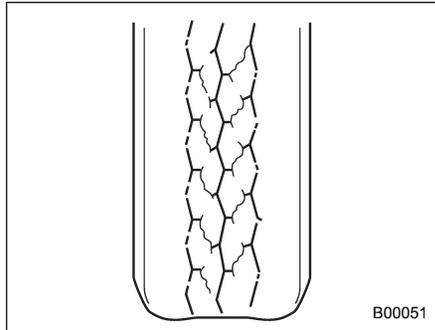

Rolling resistance is high, so fuel consumption is also higher.

- **Abnormally high tire pressure** (tread worn in center)

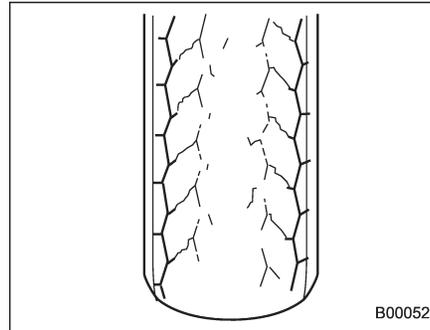

Ride comfort is poor. Also, the tire magnifies the effects of road-surface bumps and dips, possibly resulting in vehicle damage.

WARNING

Driving at high speeds with excessively low tire pressures can cause the tires to deform severely and to rapidly become hot. A sharp increase in temperature could cause tread separation, and destruction of the tires. The resulting loss of vehicle control could lead to an accident.

Wheel balance

Each wheel was correctly balanced when your vehicle was new, but the wheels will become unbalanced as the tires become worn during use. Wheel imbalance causes the steering wheel to vibrate slightly at certain vehicle speeds and detracts from the vehicle's straight-line stability. It can also cause steering and suspension system problems and abnormal tire wear. If you suspect that the wheels are not correctly balanced, have them checked and adjusted by your SUBARU dealer. Also have them adjusted after tire repairs and after tire rotation.

NOTE

Loss of correct wheel alignment* causes the tires to wear on one side and reduces the vehicle's running stability. Contact your SUBARU dealer if you notice abnormal tire wear.

*: The suspension system is designed to hold each wheel at a certain alignment (relative to the other wheels and to the road) for optimum straight-line stability and cornering performance.

■ Wear indicators

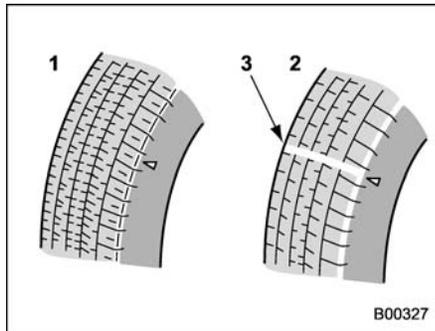

- 1) New tread
- 2) Worn tread
- 3) Tread wear indicator

Each tire incorporates a tread wear indicator, which becomes visible when the depth of the tread grooves decreases to 0.071 in (1.8 mm). A tire must be replaced when the tread wear indicator appears as a solid band across the tread.

▲ WARNING

When a tire's tread wear indicator becomes visible, the tire is worn beyond the acceptable limit and must be replaced immediately. With a tire in this condition, driving at high speeds in wet weather can

cause the vehicle to hydroplane. The resulting loss of vehicle control can lead to an accident.

NOTE

For safety, inspect the tire tread regularly and replace the tires before their tread wear indicators become visible.

■ Tire rotation direction mark

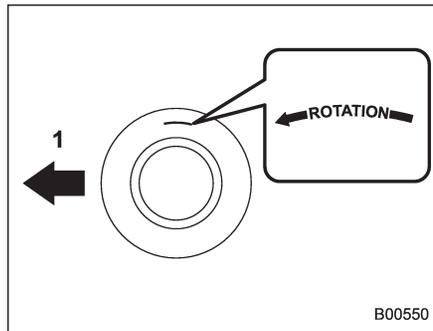

Example of tire rotation direction mark
1) Front

If the tire has the rotation direction specification, the tire rotation direction mark is placed on its sidewall. When you install a tire that has the tire rotation direction mark, install the tire with

the direction mark facing forward.

■ Tire rotation

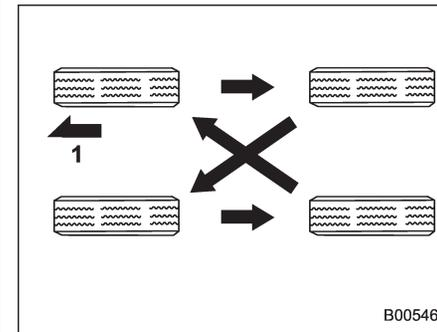

Vehicles equipped with 4 non-unidirectional tires

- 1) Front

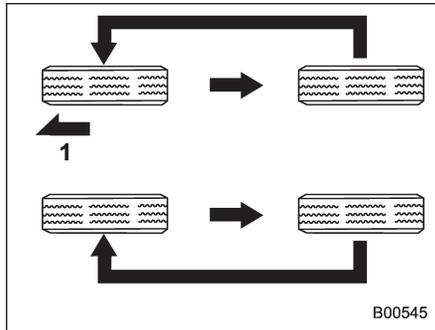

Vehicles equipped with unidirectional tires
1) Front

Tire wear varies from wheel to wheel. To maximize the life of each tire and ensure that the tires wear uniformly, it is best to rotate the tires every 7,500 miles (12,000 km). Move the tires to the positions shown in the illustration each time they are rotated.

Replace any damaged or unevenly worn tire at the time of rotation. After tire rotation, adjust the tire pressures and make sure the wheel nuts are correctly tightened.

After driving approximately 600 miles (1,000 km), check the wheel nuts again and retighten any nut that has become loose.

■ Tire replacement

The wheels and tires are important and integral parts of your vehicle's design; they cannot be changed arbitrarily. The tires fitted as standard equipment are optimally matched to the characteristics of the vehicle and were selected to give the best possible combination of running performance, ride comfort, and service life. It is essential for every tire to have a size and construction matching those shown on the tire placard and to have a speed symbol and load index matching those shown on the tire placard.

Using tires of a non-specified size detracts from controllability, ride comfort, braking performance, speedometer accuracy and odometer accuracy. It also creates incorrect body-to-tire clearances and inappropriately changes the vehicle's ground clearance.

All four tires must be the same in terms of manufacturer, brand (tread pattern), construction, and size. You are advised to replace the tires with new ones that are identical to those fitted as standard equipment.

For safe vehicle operation, SUBARU recommends replacing all four tires at the same time.

⚠ WARNING

- All four tires must be the same in terms of manufacturer, brand (tread pattern), construction, degree of wear, speed symbol, load index and size. Mixing tires of different types, sizes or degrees of wear can result in damage to the vehicle's powertrain. Use of different types or sizes of tires can also dangerously reduce controllability and braking performance and can lead to an accident.
- Use only radial tires. Do not use radial tires together with belted bias tires and/or bias-ply tires. Doing so can dangerously reduce controllability, resulting in an accident.

■ Wheel replacement

When replacing wheels due, for example, to damage, make sure the replacement wheels match the specifications of the wheels that are fitted as standard equipment. Replacement wheels are available from SUBARU dealers.

– CONTINUED –

WARNING

Use only those wheels that are specified for your vehicle. Wheels not meeting specifications could interfere with brake caliper operation and may cause the tires to rub against the wheel well housing during turns. The resulting loss of vehicle control could lead to an accident.

Aluminum wheels

- Aluminum wheels can be scratched and damaged easily. Handle them carefully to maintain their appearance, performance, and safety.

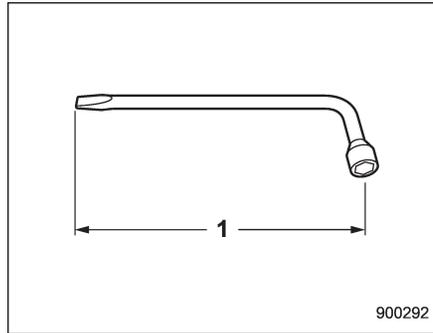

1) The length of the wheel nut wrench

CAUTION

There are 2 types of wheel nut wrenches that apply to different lengths.

For an aluminum wheel vehicle, the 11.2-inch (285 mm) wheel nut wrench is equipped as a maintenance tool. And for a chrome plated wheel vehicle, the 13.2-inch (335 mm) wheel nut wrench is equipped

as well. Always use a wheel nut wrench for an aluminum wheel. If you use a wrench for a chrome plated wheel, you cannot tighten it to the specified torque.

- When any of the wheels are removed and replaced for tire rotation or to change a flat tire, always check the tightness of the wheel nuts after driving approximately 600 miles (1,000 km). If any nut is loose, tighten it to the following specified torque. A tightening sequence specification for the wheel nuts can be found in the "Flat tires" in chapter 9.

Wheel nuts tightening torque for aluminum wheel:
74 to 89 lbf-ft (100 to 120 N·m, 10 to 12 kgf·m)

This torque is equivalent to applying approximately 88 to 110 lbs (40 to 50 kg) at the top of the wheel nut wrench.

- Never apply oil to the threaded parts, wheel nuts, or tapered surface of the wheel.
- Never let the wheel rub against sharp protrusions or curbs.
- Be sure to fit tire chains on uniformly and completely around the tire, otherwise the chains may scratch the wheel.
- When wheel nuts, balance weights, or

the center cap is replaced, be sure to replace them with genuine SUBARU parts designed for aluminum wheels.

Chrome plated wheels (if equipped)

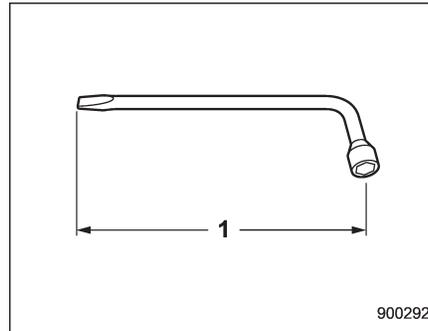

1) The length of the wheel nut wrench

CAUTION

There are 2 types of wheel nut wrenches that apply to different lengths.

For an aluminum wheel vehicle, the 11.2-inch (285 mm) wheel nut wrench is equipped as a maintenance tool. And for a chrome plated wheel vehicle, the 13.2-inch (335 mm) wheel nut wrench is equipped as well. Always use a wheel nut wrench for a chrome plated wheel. If you use a wrench for an aluminum

wheel, you cannot tighten it to the specified torque.

- When any of the wheels are removed and replaced for tire rotation or to change a flat tire, always check the tightness of the wheel nuts after driving approximately 600 miles (1,000 km). If any nut is loose, tighten it to the following specified torque. A tightening sequence specification for the wheel nuts can be found in the "Flat tires" in chapter 9.

Wheel nuts tightening torque for chrome plated wheel:

89 to 111 lbf-ft (120 to 150 N·m, 12 to 15 kgf·m)

This torque is equivalent to applying approximately 86 to 108 lbs (39 to 49 kg) at the top of the wheel nut wrench.

- Never apply oil to the threaded parts, wheel nuts, or tapered surface of the wheel.
- Never let the wheel rub against sharp protrusions or curbs.
- Be sure to fit tire chains on uniformly and completely around the tire, otherwise the chains may scratch the wheel.
- When wheel nuts, balance weights, or the center cap is replaced, be sure to replace them with genuine SUBARU parts designed for chrome plated wheels.

Windshield washer fluid

CAUTION

Never use engine coolant as washer fluid because it could cause paint damage.

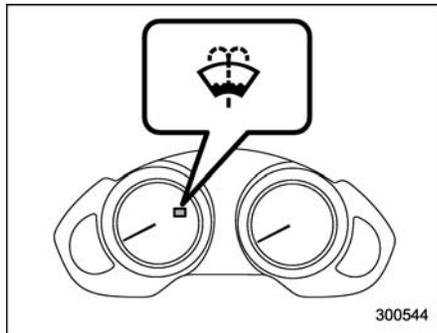

If you spray washer fluid on the windshield but the windshield washer fluid warning light illuminates or the supply of washer fluid drops, check the level of washer fluid in the tank.

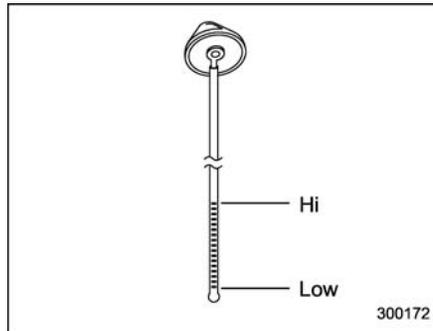
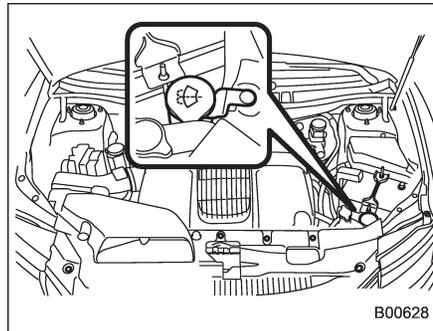

Washer fluid level gauge

Remove the washer tank filler cap, then check the fluid level indicated by the level gauge (attached to the inside of the cap). If the level is near the "Low" mark, add fluid until it reaches the "Hi" level on the

level gauge.

After adding fluid, make sure the windshield washer fluid warning light has turned off.

Use windshield washer fluid. If windshield washer fluid is unavailable use clean water.

In areas where water freezes in winter, use an anti-freeze type windshield washer fluid. SUBARU Windshield Washer Fluid contains 58.5% methyl alcohol and 41.5% surfactant, by volume. Its freezing temperature varies according to how much it is diluted, as indicated in the following table.

Washer Fluid Concentration	Freezing Temperature
30%	10.4°F (-12°C)
50%	-4°F (-20°C)
100%	-49°F (-45°C)

CAUTION

Never use engine coolant as washer fluid because it could cause paint damage.

In order to prevent freezing of washer fluid, check the freezing temperatures in the table above when adjusting the fluid

concentration to the outside temperature. If you fill the reservoir tank with a fluid with a different concentration from the one used previously, purge the old fluid from the piping between the reservoir tank and washer nozzles by operating the washer for a certain period of time. Otherwise, if the concentration of the fluid remaining in the piping is too low for the outside temperature, it may freeze and block the nozzles.

 **CAUTION**

Adjust the washer fluid concentration appropriately for the outside temperature. If the concentration is inappropriate, sprayed washer fluid may freeze on the windshield and obstruct your view, and the fluid may freeze in the reservoir tank.

Replacement of wiper blades

Grease, wax, insects, or other materials on the windshield or the wiper blade results in jerky wiper operation and streaking on the glass. If you cannot remove the streaks after operating the windshield washer or if the wiper operation is jerky, clean the outer surface of the windshield (or rear window) and the wiper blades using a sponge or soft cloth with a neutral detergent or mild-abrasive cleaner. After cleaning, rinse the windshield and wiper blades with clean water. The windshield is clean if beads do not form when you rinse the windshield with water.

 **CAUTION**

- Do not clean the wiper blades with gasoline or a solvent, such as paint thinner or benzene. This will cause deterioration of the wiper blades.
- When you wish to raise the passenger-side wiper arm, first raise the driver-side wiper arm. Otherwise, the passenger-side wiper assembly and driver-side wiper assembly will touch each other, possibly resulting in scratches.

- Return the passenger-side wiper arm to its original position before returning the driver-side wiper arm to its original position. Otherwise, the passenger-side wiper assembly and driver-side wiper assembly will touch each other, possibly resulting in scratches.

If you cannot eliminate the streaking even after following this method, replace the wiper blades using the following procedures. Be sure to use genuine SUBARU wiper blade rubbers as replacements.

■ Windshield wiper blade assembly

1. Raise the windshield wiper arm on the driver's side.
2. Next, raise the windshield wiper arm on the passenger's side.

– CONTINUED –

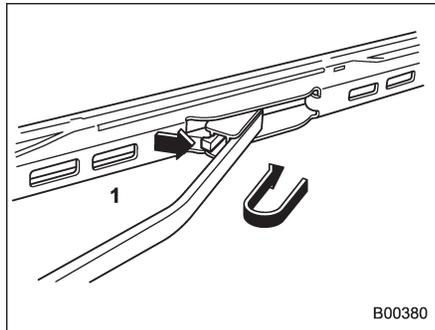

1) Stopper

3. Remove the wiper blade assembly by holding its pivot area and pushing it in the direction shown by the arrow while depressing the wiper blade stopper.
4. Install the wiper blade assembly to the wiper arm. Make sure that it locks in place.
5. Lower the windshield wiper arm on the passenger's side slowly while supporting it by hand.
6. Next, lower the windshield wiper arm on the driver's side slowly while supporting it by hand.

CAUTION

Do not let go of the wiper arm until it touches the windshield. Letting the

wiper arm snap onto the windshield could damage it.

■ Windshield wiper blade rubber

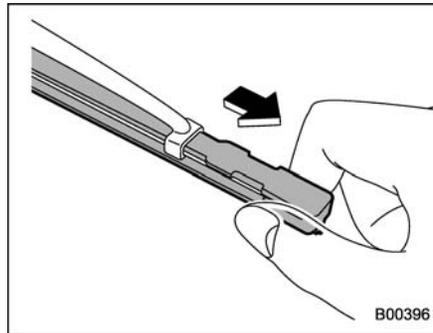

1) Metal support

1. Grasp the locked end of the blade rubber assembly and pull it firmly until the stoppers on the rubber are free of the metal support.

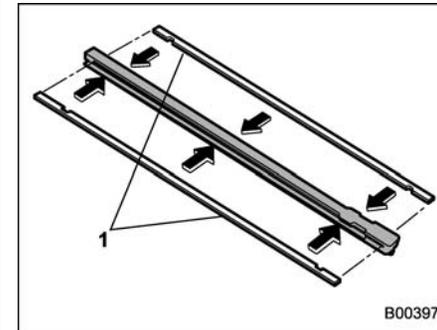

1) Metal spines

2. If the new blade rubber is not provided with two metal spines, remove the metal spines from the old blade rubber and install them in the new blade rubber.

CAUTION

Be sure to install each metal spine so as to fit its groove completely on the center ridge of the blade rubber. Doing otherwise may result in dislocation and breakage of the spine during wiper operation.

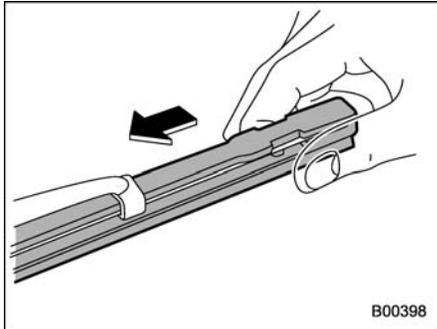

3. Align the claws of the metal support with the grooves in the rubber and slide the blade rubber assembly into the metal support until it locks.

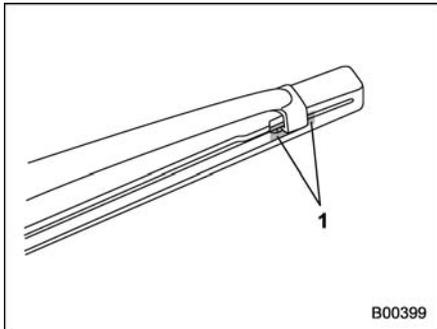

1) Stopper

4. Be sure to position the claws at the

end of the metal support between the stoppers on the rubber as shown. If the rubber is not retained properly, the wiper blade may scratch the windshield.

■ Rear window wiper blade assembly

1. Raise the wiper arm off the rear window.

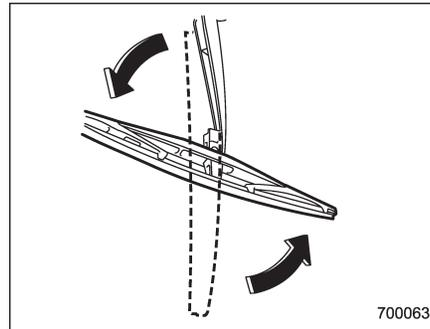

2. Turn the wiper blade assembly counterclockwise.

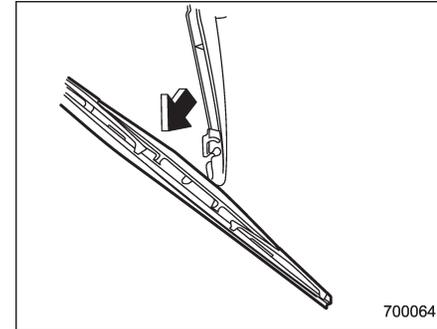

3. Pull the wiper blade assembly toward you to remove it from the wiper arm.

■ Rear window wiper blade rubber

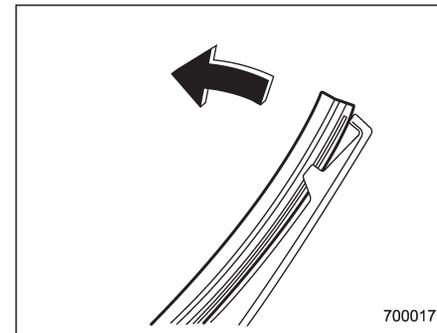

– CONTINUED –

11-36 Maintenance and service

1. Pull out the end of the blade rubber assembly to unlock it from the plastic support.

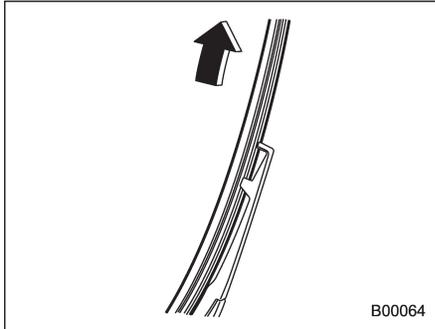

2. Pull the blade rubber assembly out of the plastic support.

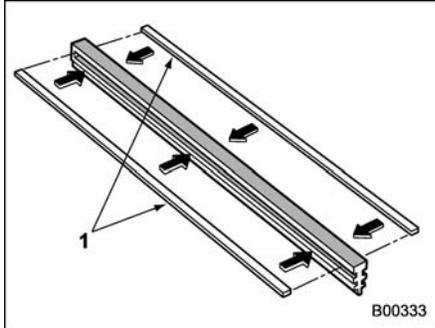

1) Metal spines

3. If the new blade rubber is not provided with two metal spines, remove the metal spines from the old blade rubber and install them in the new blade rubber.

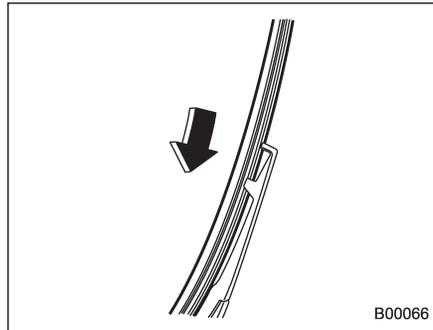

4. Align the claws of the plastic support with the grooves in the blade rubber assembly, then slide the blade rubber assembly into place.

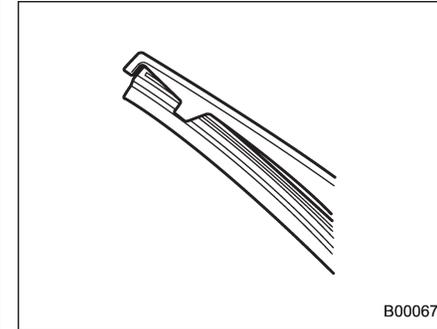

Securely retain both ends of the rubber with the stoppers on the plastic support ends. If the rubber is not retained properly, the wiper may scratch the rear window glass.

5. Install the wiper blade assembly to the wiper arm. Make sure that it locks in place.
6. Hold the wiper arm by hand and slowly lower it in position.

Battery

WARNING

- Before beginning work on or near any battery, be sure to extinguish all cigarettes, matches, and lighters. Never expose a battery to an open flame or electric sparks. Batteries give off a gas which is highly flammable and explosive.
- For safety, in case an explosion does occur, wear eye protection or shield your eyes when working near any battery. Never lean over a battery.
- Do not let battery fluid contact eyes, skin, fabrics, or paint because battery fluid is a corrosive acid. If battery fluid gets on your skin or in your eyes, immediately flush the area with water thoroughly. Seek medical help immediately if acid has entered the eyes.

If battery fluid is accidentally swallowed, immediately drink a large amount of milk or water, and seek medical attention immediately.

- To lessen the risk of sparks,

remove rings, metal watchbands, and other metal jewelry. Never allow metal tools to contact the positive battery terminal and anything connected to it WHILE you are at the same time in contact with any other metallic portion of the vehicle because a short circuit will result.

- Keep everyone including children away from the battery.
- Charge the battery in a well-ventilated area.
- Battery posts, terminals, and related accessories contain lead and lead compounds, chemicals known to the State of California to cause cancer and reproductive harm. Batteries also contain other chemicals known to the State of California to cause cancer. Wash hands after handling.

CAUTION

Never use more than 10 amperes when charging the battery because it will shorten battery life.

It is unnecessary to periodically check the battery fluid level or periodically refill with

distilled water.

Fuses

CAUTION

Never replace a fuse with one having a higher rating or with material other than a fuse because serious damage or a fire could result.

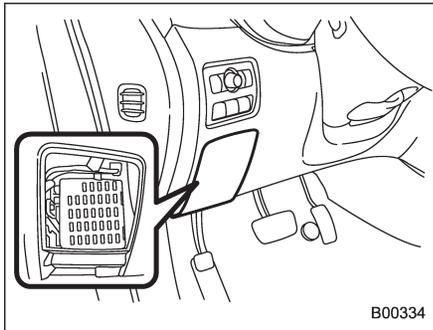

The fuses are designed to melt during an overload to prevent damage to the wiring harness and electrical equipment. The fuses are located in two fuse boxes. One is located under the instrument panel behind the fuse box cover on the driver's seat side.

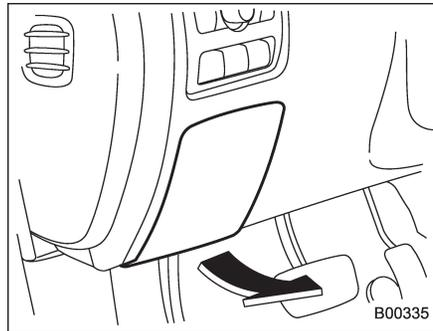

Open the lid that is located above the hood release knob and pull it toward you to remove it.

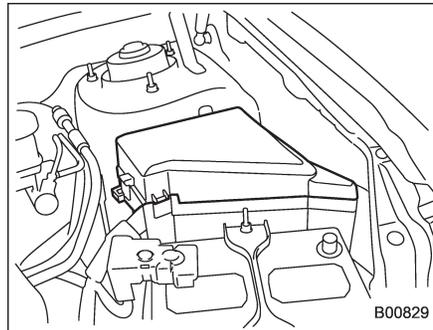

The other one is housed in the engine compartment.

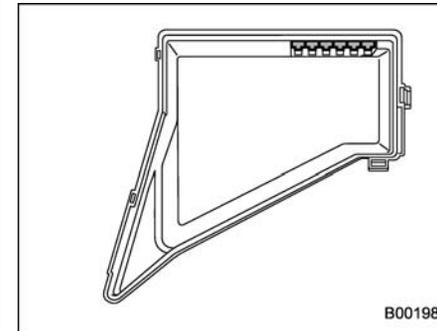

The spare fuses are stored in the main fuse box cover in the engine compartment.

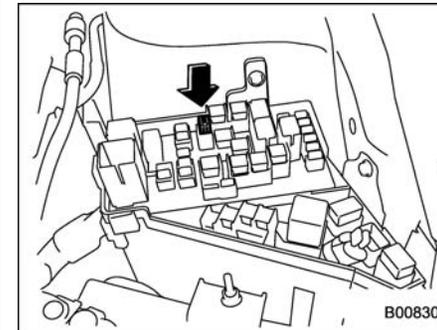

The fuse puller is stored in the main fuse box in the engine compartment.

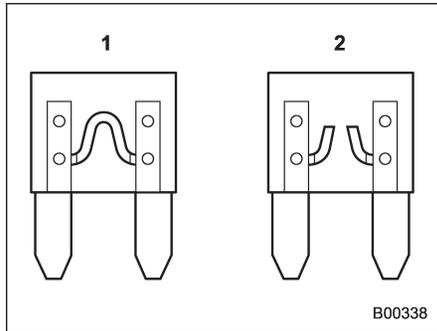

- 1) Good
- 2) Blown

If any lights, accessories or other electrical controls do not operate, inspect the corresponding fuse. If a fuse has blown, replace it.

1. Turn the ignition switch to the "LOCK" position and turn off all electrical accessories.
2. Remove the cover.
3. Determine which fuse may be blown. The back side of each fuse box cover and the "Fuses and circuits" section in chapter 12 in this manual show the circuit for each fuse.

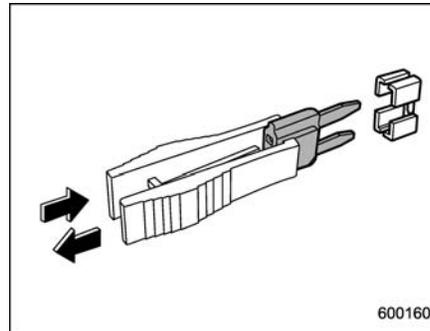

4. Pull out the fuse with the fuse puller.
5. Inspect the fuse. If it has blown, replace it with a spare fuse of the same rating.
6. If the same fuse blows again, this indicates that its system has a problem. Contact your SUBARU dealer for repairs.

Main fuse

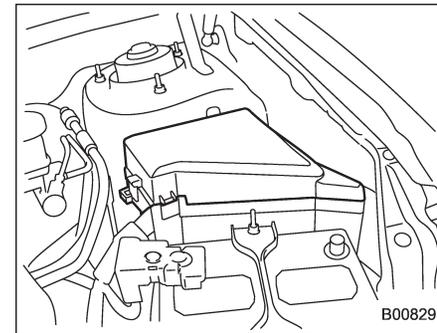

Main fuse box

The main fuses are designed to melt during an overload to prevent damage to the wiring harness and electrical equipment. Check the main fuses if any electrical component fails to operate (except the starter motor) and other fuses are good. A melted main fuse must be replaced. Use only replacements with the same specified rating as the melted main fuse. If a main fuse blows after it is replaced, have the electrical system checked by your nearest SUBARU dealer.

Installation of accessories

Always consult your SUBARU dealer before installing fog lights or any other electrical equipment in your vehicle. Such accessories may cause the electronic system to malfunction if they are incorrectly installed or if they are not suited for the vehicle.

Replacing bulbs

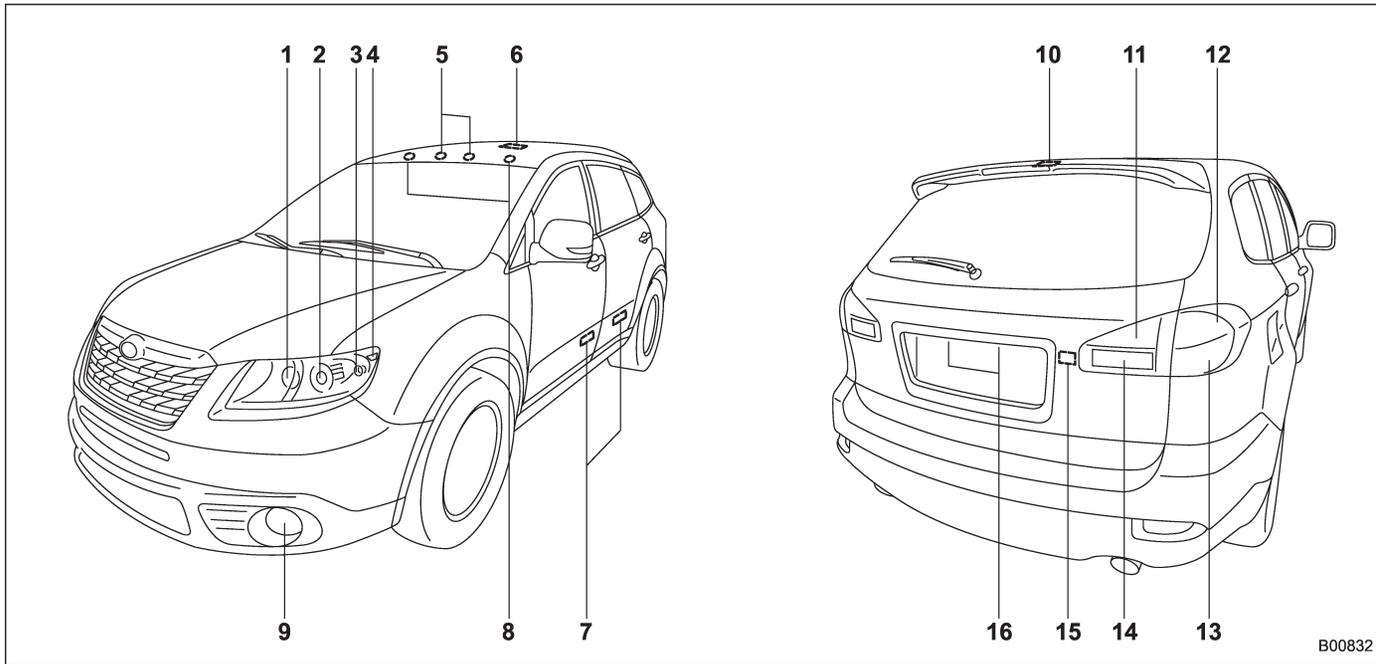

- CONTINUED -

11-42 Maintenance and service

	Wattage	Bulb No.
1) High beam headlight	12V-65W	HB3
2) Low beam headlight		
Vehicles with HID light	12V-35W	D1S
Vehicles without HID light	12V-55W	H7
3) Front turn signal/Parking light	12V-28/8W	2357NA
4) Parking/Front side marker light	12V-5W	168(W5W)
5) Map light	12V-8W	–
6) Dome light		
Vehicles with Rear Seat Entertainment	12V-5W	–
Vehicles without Rear Seat Entertainment	12V-8W	–
7) Door step light	12V-3W	–
8) Vanity mirror light	12V-3W	
9) Fog light	12V-55W	H3
10) Cargo area light	12V-13W	912
11) Tail light	12V-5W	168(W5W)
12) Brake/tail light	12V-27/8W	1157(W27/8W)
13) Rear turn signal light	12V-27W	1156(W27W)
14) Back-up light	12V-16W	921
15) Rear gate light	12V-5W	(W5W)
16) License plate light	12V-5W	168(W5W)

CAUTION

Replace any bulb only with a new bulb of the specified wattage. Using a bulb of different wattage could result in a fire.

■ Headlights (vehicles with HID headlights)

WARNING

High-intensity-discharge (HID) bulbs are used for the low beams of the headlights. These HID bulbs use an extremely high voltage. To avoid the risk of an electric shock and resulting serious injury, you should not attempt to replace them. Neither should you attempt to replace the high-beam bulbs, remove/refit the headlight assemblies, or remove any headlight-assembly components. For replacement of the headlight bulbs (low-beam and high-beam), removal and installation of the headlight assemblies, and removal of headlight-assembly components, contact your SUBARU dealer.

■ **Headlights (vehicles without HID headlights)**

CAUTION

Halogen headlight bulbs become very hot while in use. If you touch the bulb surface with bare hands or greasy gloves, finger prints or grease on the bulb surface develop into hot spots, causing the bulb to break. If there are finger prints or grease on the bulb surface, wipe them away with a soft cloth moistened with alcohol.

NOTE

- If headlight aiming is required, consult your SUBARU dealer for proper adjustment of the headlight aim.
- It may be difficult to replace the bulbs. Have the bulbs replaced by your SUBARU dealer if necessary.

▼ **Low beam light bulbs (right-hand side)**

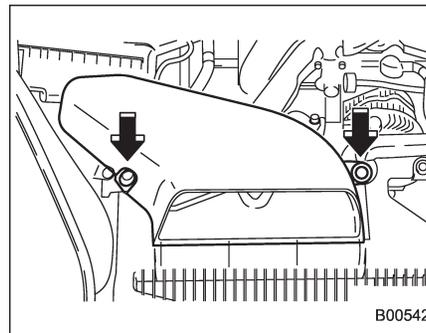

1. Use a screwdriver to undo the clips on the air intake duct, then remove the air intake duct.

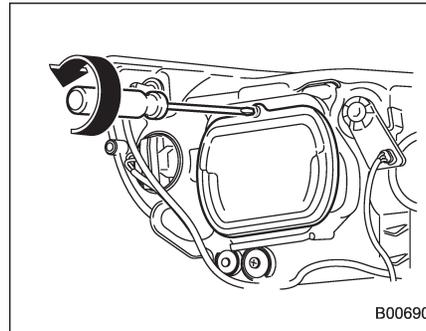

2. Use a screwdriver to remove the bulb cover.

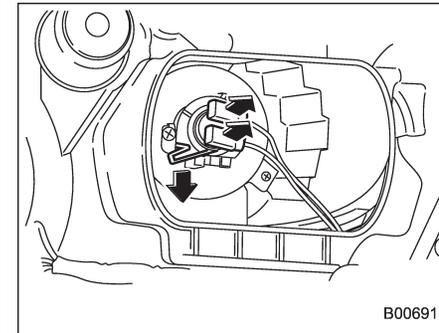

3. Disconnect the electrical connector.
4. Remove the retainer spring.
5. Replace the bulb, then set the retainer spring securely.
6. Reconnect the electrical connector.
7. Install the bulb cover with the fixing screws.
8. Install the air intake duct with the clips.

NOTE

Contact your SUBARU dealer for the bulb replacement of the left-hand side.

▼ High beam light bulbs

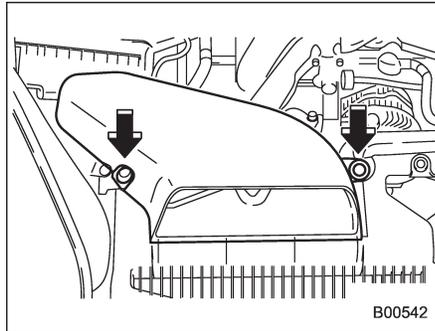

Right-hand side

1. Use a screwdriver to undo the clips on the air intake duct, then remove the air intake duct. (right-hand side)

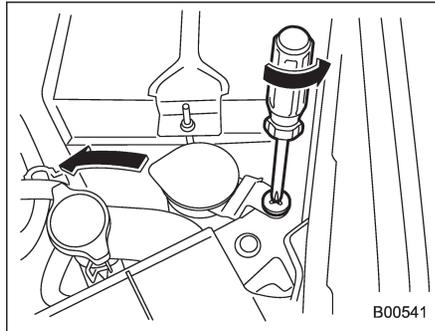

Left-hand side

2. Use a screwdriver to remove the secured clip of the washer tank. To make it easy to access the bulb, move the washer tank to the horizontal direction. (left-hand side)

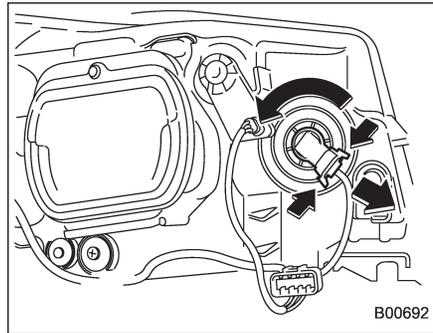

3. Disconnect the electrical connector from the bulb.
4. Remove the bulb from the headlight assembly by turning it counterclockwise.
5. Replace the bulb with new one. At this time, use care not to touch the bulb surface.
6. Reconnect the electrical connector.
7. To install the bulb to the headlight assembly, turn it clockwise until it clicks.
8. Install the air intake duct with clips. (right-hand side)
9. Set the washer tank to the original

place and secure it by clip. (left-hand side)

■ Parking light (right-hand side)

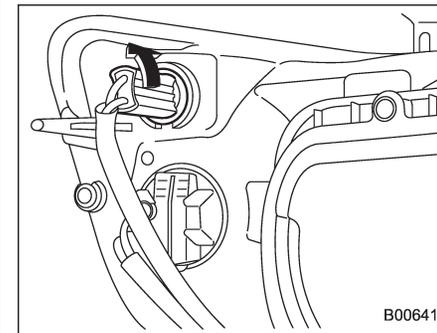

1. Remove the bulb socket from the headlight assembly by turning it counterclockwise.

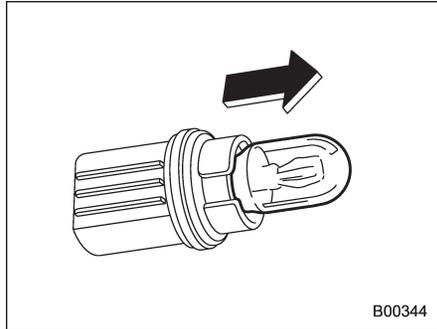

2. Pull the bulb out of the socket.
3. Install a new bulb.
4. Set the bulb socket into the headlight assembly and turn it clockwise until it locks.

NOTE

Contact your SUBARU dealer for the bulb replacement of the left-hand side.

Front turn signal light (right-hand side)

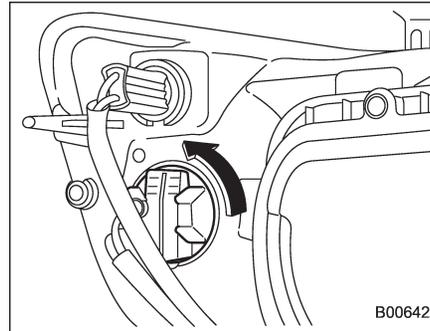

1. Remove the bulb socket from the headlight assembly by turning it counterclockwise.

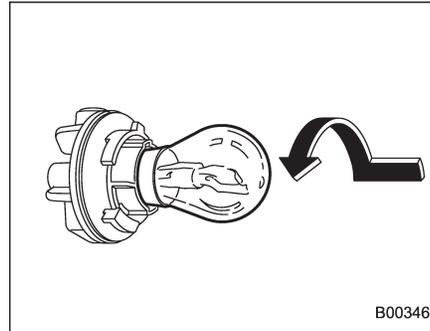

2. Remove the bulb from the socket by pushing it and turning counterclockwise.
3. Install a new bulb.
4. Set the bulb socket into the headlight assembly and turn it clockwise until it locks.

NOTE

Contact your SUBARU dealer for the bulb replacement of the left-hand side.

Front fog light

It may be difficult to replace the bulbs. Have the bulbs replaced by your SUBARU dealer if necessary.

■ Rear combination lights

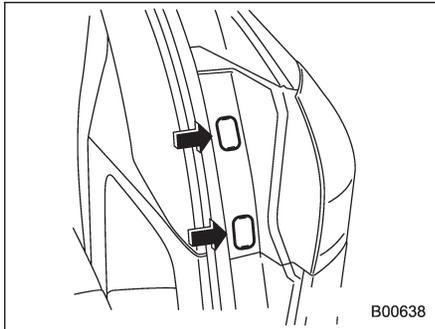

1. Remove the two covers by inserting the tip of a flat-head screwdriver.

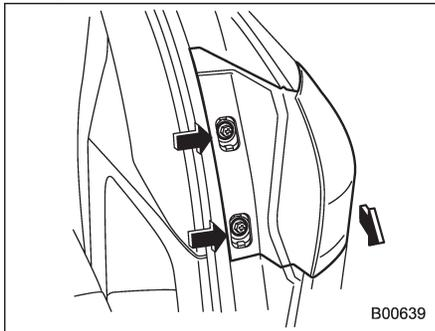

2. Using a Phillips screwdriver, remove the upper and lower screws. Then, slide

the rear combination light assembly rearward and remove it from the vehicle.

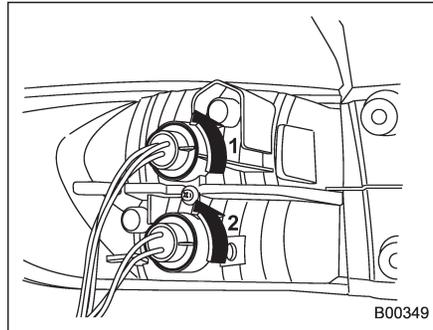

- 1) Brake/tail light
- 2) Rear turn signal light

3. Remove the bulb holder from the rear combination light assembly by turning it counterclockwise.

4. Remove the bulb from the socket by pushing it and turning counterclockwise.

5. Install a new bulb.

6. Set the bulb holder into the rear combination light assembly and turn it clockwise until it locks.

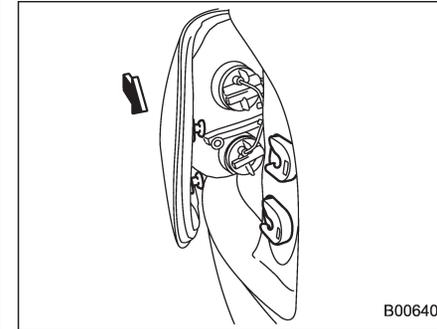

7. Reinstall the rear combination light assembly by sliding the two-pronged part of the combination light assembly securely to each holder of the vehicle side.

8. Tighten the two mounting screws, and then close the covers.

■ Back-up light/Tail light

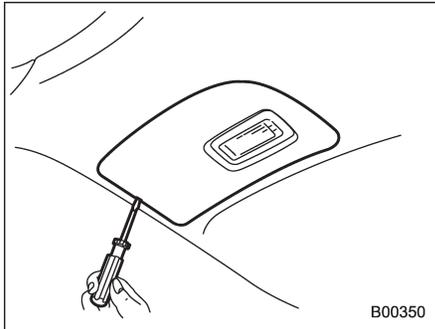

1. Use a flat-head screwdriver to remove the light cover from the rear gate trim.

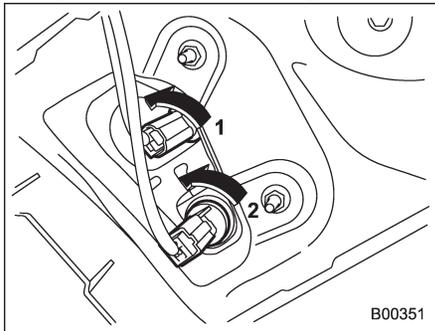

- 1) Tail light
- 2) Back-up light

2. Turn the bulb socket counterclockwise and remove it.
3. Pull the bulb out of the bulb socket and replace it with a new one.
4. Install the bulb socket by turning it clockwise.
5. Install the light cover on the rear gate.

■ Rear gate light

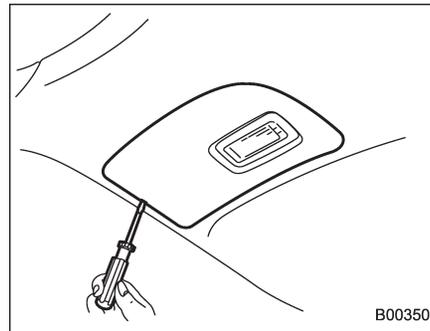

1. Use a flat-head screwdriver to remove the rear gate light assembly from the rear gate trim.

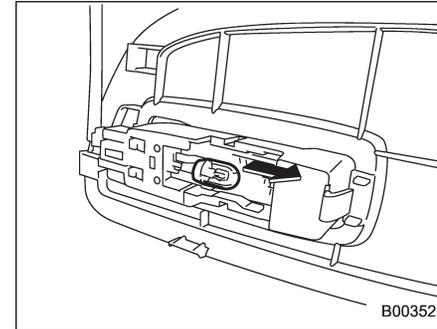

2. Pull the bulb out of the bulb socket and replace it with a new one.
3. Install the rear gate light assembly on the rear gate.

■ License plate light

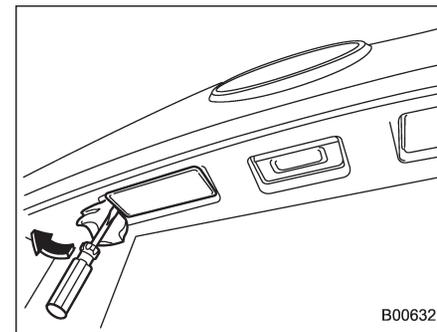

- CONTINUED -

11-48 *Maintenance and service*

1. Wrap a flat-head screwdriver in vinyl tape or cloth, insert it into the gap between the license plate light assembly and the rear gate.
2. Carefully pry the light assembly to remove it.

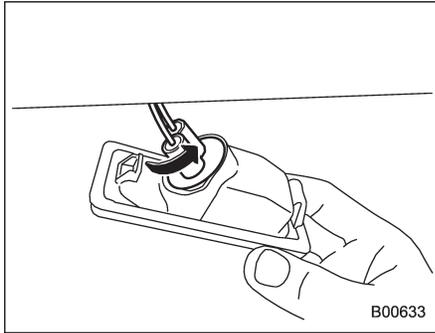

3. Remove the bulb socket from the license plate light assembly by turning it counterclockwise.

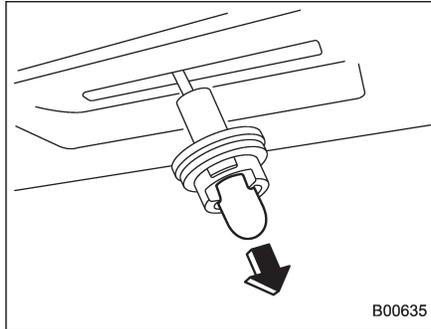

4. Pull the bulb out of the socket. Install a new bulb.
5. Set the bulb socket into the license plate light assembly and turn it clockwise until it locks.
6. Reinstall the license plate light assembly to the rear gate.

■ Dome light

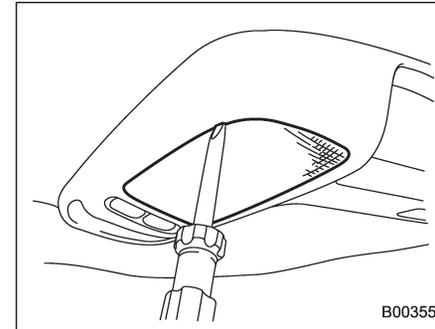

Vehicles with Rear Seat Entertainment

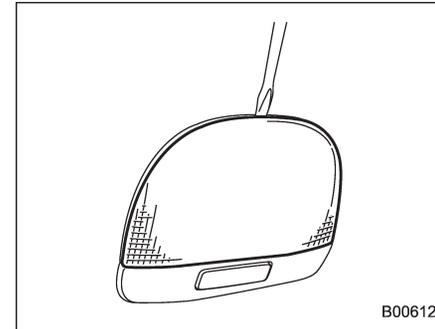

Vehicles without Rear Seat Entertainment

1. Remove the lens by prying the edge of the lens with a flat-head screwdriver.

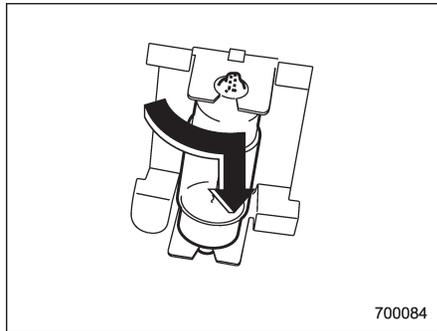

2. Turn the bulb until the flat surfaces at its ends are aligned vertically. Pull the bulb straight downward to remove it.
3. Install a new bulb.
4. Reinstall the lens.

■ Map light

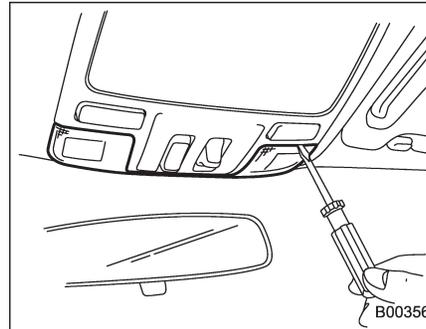

1. Remove the lens by prying the edge of the lens with a flat-head screwdriver.

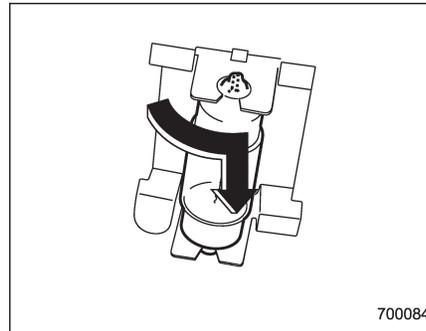

2. Turn the bulb until the flat surfaces at its ends are aligned vertically. Pull the bulb

- straight downward to remove it.
3. Install a new bulb.
4. Reinstall the lens.

■ Vanity mirror light

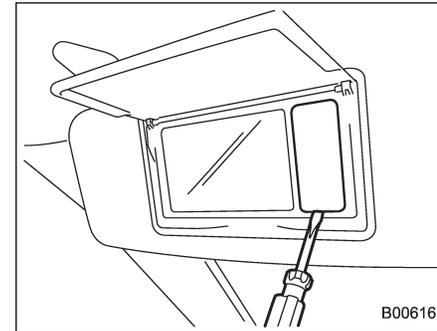

1. Remove the lens by prying the edge of the lens with a flat-head screwdriver.

– CONTINUED –

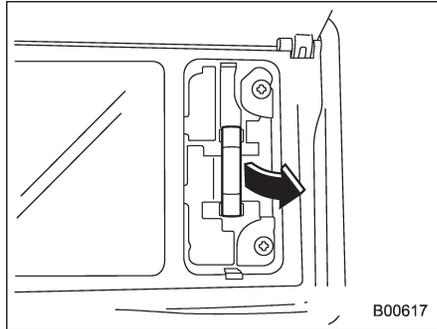

2. Pull the bulb out of the socket.
3. Install a new bulb.
4. Reinstall the lens.

■ Door step light

It may be difficult to replace the bulbs. Have the bulbs replaced by your SUBARU dealer if necessary.

■ Cargo area light

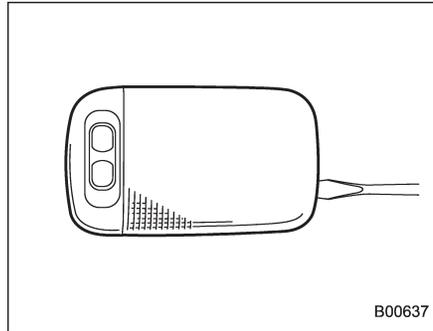

1. Remove the cargo area light assembly by prying the edge of the light with a flat-head screwdriver.
2. Remove the lens from the cargo area light assembly.

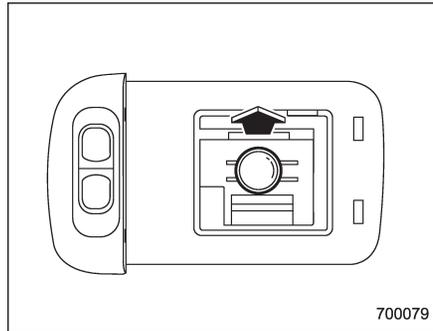

3. Pull the bulb out of the socket.
4. Install a new bulb.
5. Reinstall the lens to the cargo area light assembly.
6. Reinstall the cargo area light assembly to the roof trim.

Specifications

Specifications	12-2	Fuses and circuits	12-5
Dimensions	12-2	Fuse panel located in the passenger	
Engine	12-2	compartment	12-5
Electrical system	12-3	Fuse panel located in the engine	
Capacities	12-3	compartment	12-7
Tires	12-3	Bulb chart	12-8
Wheel alignment	12-4	Vehicle identification	12-9

12-2 Specifications

Specifications

These specifications are subject to change without notice.

■ Dimensions

		in (mm)
Overall length		191.5 (4,865)
Overall width		73.9 (1,878)
Overall height	Without roof rail	66.4 (1,686)
	With roof rail	67.7 (1,720)
Wheel base		108.2 (2,749)
Tread	Front	62.2 (1,580)
	Rear	62.1 (1,578)
Ground clearance		8.4 (213)

■ Engine

Engine model	EZ36D (3.6 L, DOHC, non-turbo)
Engine type	Horizontally opposed, liquid cooled 6 cylinder, 4 stroke gasoline engine
Displacement cc (cu-in)	3,630 (222)
Bore × Stroke in (mm)	3.62 × 3.58 (92.0 × 91.0)
Compression ratio	10.5 : 1
Firing order	1 – 6 – 3 – 2 – 5 – 4

■ Electrical system

Battery type and capacity (5HR)	75D23L (12V-52AH)
Alternator	12V-130A
Spark plugs	SILFR6A (NGK)

■ Capacities

Fuel tank	16.9 US gal (64 liters, 14.1 Imp gal)
Engine oil	6.7 US qt (6.3 liters, 5.5 Imp qt)
Transmission fluid	10.4 US qt (9.8 liters, 8.6 Imp qt)
Front differential gear oil	1.5 US qt (1.4 liters, 1.2 Imp qt)
Rear differential gear oil	0.8 US qt (0.8 liter, 0.7 Imp qt)
Power steering fluid	0.9 US qt (0.9 liter, 0.8 Imp qt)
Engine coolant	8.0 US qt (7.6 liters, 6.7 Imp qt)

■ Tires

Tire size	P255/55R18 104H	
Wheel size	18 × 8JJ	
Pressure	Front	33 psi (230 kPa, 2.3 kgf/cm ²)
	Rear	32 psi (220 kPa, 2.2 kgf/cm ²)
	Rear at trailer towing	32 psi (220 kPa, 2.2 kgf/cm ²)
Temporary spare tire	Size	T165/80R17
	Pressure	60 psi (420 kPa, 4.2 kgf/cm ²)

– CONTINUED –

12-4 Specifications

■ Wheel alignment

Toe	Front	0 in (0 mm)
	Rear	0.0787 in (2 mm)
Camber	Front	0°00'
	Rear	-0°31'

Fuses and circuits

■ Fuse panel located in the passenger compartment

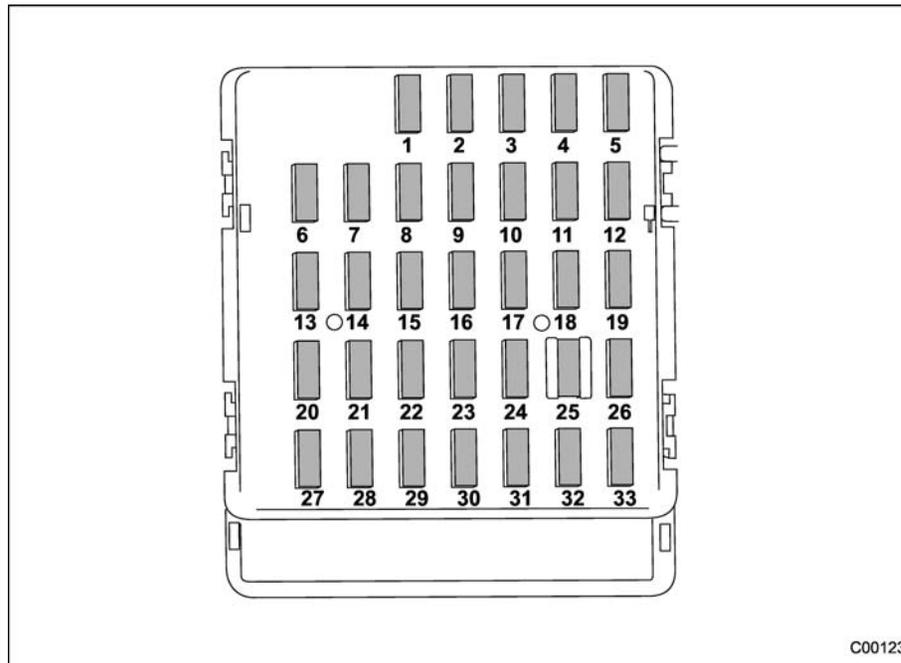

C00123

Fuse panel	Fuse rating	Circuit
1	20A	• Trailer hitch connector
2	Empty	
3	15A	• Door locking
4	7.5A	• Front wiper deicer relay • Moonroof
5	7.5A	• Combination meter
6	7.5A	• Remote control rear view mirrors • Seat heater relay
7	15A	• Combination meter • Integrated unit
8	15A	• Stop light
9	20A	• Mirror heater • Front wiper deicer
10	7.5A	• Power supply (battery)
11	7.5A	• Turn signal unit
12	15A	• Automatic transmission unit • SRS airbag system (sub) • Engine control unit • Integrated unit

– CONTINUED –

12-6 Specifications

Fuse panel	Fuse rating	Circuit
13	20A	• Cargo socket
14	15A	• Position light • Tail light • Rear combination light
15	Empty	
16	10A	• Illumination
17	15A	• Seat heaters
18	10A	• Back-up light
19	7.5A	• Headlight right side relay
20	Empty	
21	7.5A	• Starter relay
22	15A	• Air conditioner • Rear window defogger relay coil
23	15A	• Rear wiper • Rear window washer
24	15A	• Audio unit
25	15A	• SRS airbag system (main)
26	7.5A	• Power window relay
27	15A	• Rear blower fan

Fuse panel	Fuse rating	Circuit
28	15A	• Rear blower fan
29	15A	• Fog light
30	30A	• Front wiper
31	7.5A	• Auto air conditioner unit • Integrated unit
32	7.5A	• Headlight left side relay
33	7.5A	• Vehicle dynamics control unit

■ Fuse panel located in the engine compartment

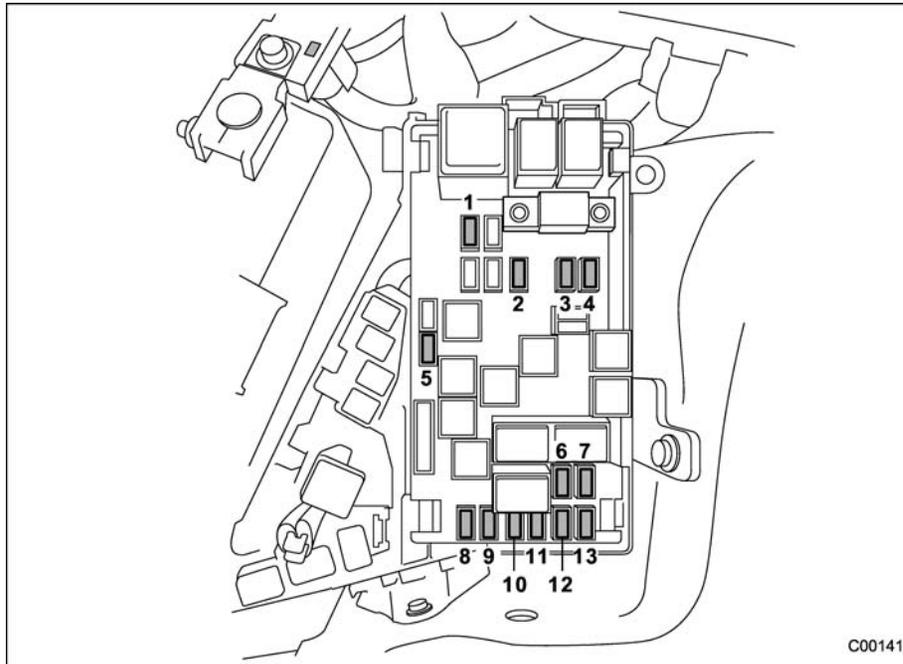

Fuse panel	Fuse rating	Circuit
1	30A	• Vehicle dynamics control unit
2	20A	• Console socket
3	15A	• Headlight (right side)
4	15A	• Headlight (left side)
5	20A	• Backup
6	15A	• Horn
7	25A	• Rear window defogger
8	15A	• Fuel pump
9	15A	• Automatic transmission control unit
10	7.5A	• Engine control unit
11	15A	• Turn and hazard warning flasher
12	20A	• Parking switch
13	7.5A	• Alternator

12-8 Specifications

Bulb chart

Description	Wattage	Bulb No.
High beam headlight	12V-65W	HB3
Low beam headlight		
Vehicles with HID light	12V-35W	D1S
Vehicles without HID light	12V-55W	H7
Fog light	12V-55W	H3
Front turn signal/Parking light	12V-28/8W	2357NA
Parking/Front side marker light	12V-5W	168(W5W)
Rear combination light		
Rear turn signal light	12V-27W	1156(W27W)
Brake/tail	12V-27/8W	1157(W27/8W)
Tail light	12V-5W	168(W5W)
Back-up light	12V-16W	921
License plate light	12V-5W	168(W5W)
Cargo area light	12V-13W	912
Dome light		
Vehicles with Rear Seat Entertainment	12V-5W	—
Vehicles without Rear Seat Entertainment	12V-8W	—
Map light	12V-8W	—
Vanity mirror light	12V-3W	—
Door step light	12V-3W	—
Rear gate light	12V-5W	(W5W)

Vehicle identification

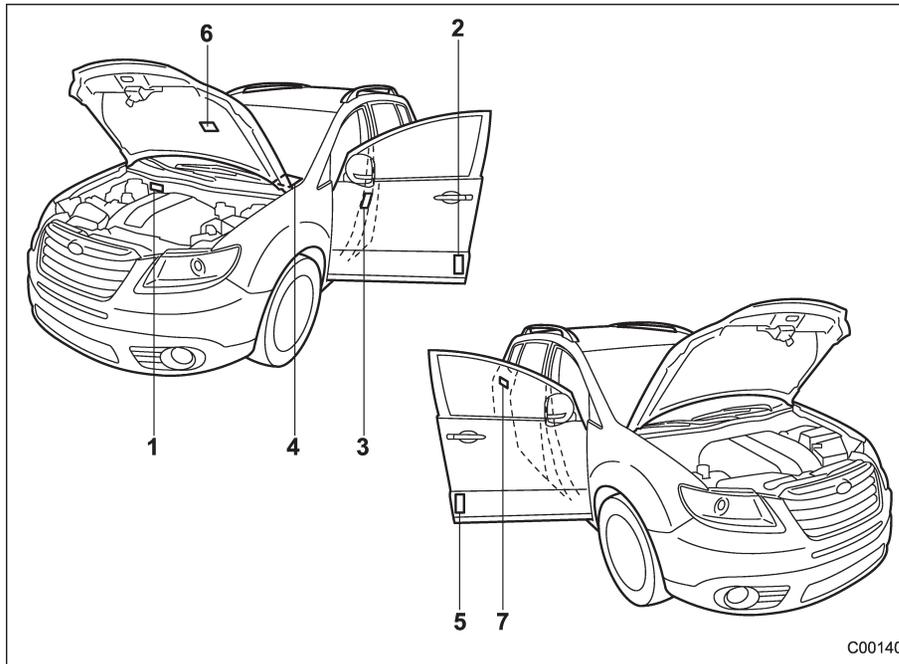

- 1) Vehicle identification number
- 2) Certification and bar code label
- 3) Tire inflation pressure label
- 4) Vehicle identification number plate
- 5) Model number label
- 6) Emission control label
- 7) Fuel label

Consumer information and Reporting safety defects

For U.S.A.	13-2	Adverse safety consequences of overloading on handling and stopping and on tires	13-11
Tire information	13-2	Steps for Determining Correct Load Limit.....	13-11
Tire labeling	13-2	Uniform tire quality grading standards	13-12
Recommended tire inflation pressure.....	13-5	Treadwear	13-12
Glossary of tire terminology	13-6	Traction AA, A, B, C.....	13-12
Tire care – maintenance and safety practices.....	13-7	Temperature A, B, C.....	13-13
Vehicle load limit – how to determine.....	13-8	Reporting safety defects (U.S.A.)	13-14
Determining compatibility of tire and vehicle load capacities	13-11		

For U.S.A.

The following information has been compiled according to Code of Federal Regulations "Title 49, Part 575".

Tire information

■ Tire labeling

Many markings (e.g. Tire size, Tire Identification Number or TIN) are placed on the sidewall of a tire by tire manufacturers. These markings can provide you with useful information on the tire.

▼ Tire size

Your vehicle comes equipped with P-Metric tire size. It is important to understand the sizing system in selecting the proper tire for your vehicle. Here is a brief review of the tire sizing system with a breakdown of its individual elements.

▽ P Metric

With the P-Metric system, Section Width is measured in millimeters. To convert millimeters into inches, divide by 25.4. The Aspect Ratio (Section Height divided by Section Width) helps provide more dimensional information about the tire size.

Example:

P 255 / 55 R 18
(1) (2) (3) (4) (5)

- (1) P = Certain tire type used on light duty vehicles such as passenger cars
- (2) Section Width in millimeters
- (3) Aspect Ratio (= section height ÷ section width).
- (4) R = Radial Construction
- (5) Rim diameter in inches

▽ Load and Speed Rating Descriptions

The load and speed rating descriptions will appear following the size designation.

They provide two important facts about the tire. First, the number designation is its load index. Second, the letter designation indicates the tire's speed rating.

Example:

P 255 / 55 R 18 104 H
 Size designation (6) (7)

(6) Load Index: A numerical code which specifies the maximum load a tire can carry at the speed indicated by its speed symbol, at maximum inflation pressure.

For example, "104" means 1,984 lbs (900 kg), "100" means 1,764 lbs (800 kg), "90" means 1,323 lbs (600 kg).

⚠ WARNING

Load indices apply only to the tire, not to the vehicle. Putting a load rated tire on any vehicle does not mean the vehicle can be loaded up to the tire's rated load.

(7) Speed Rating: An alphabetical system describing a tire's capability to travel at established and predetermined speeds.

For example, "H" means 130 mph

(210 km/h).

⚠ WARNING

- **Speed ratings apply only to the tire, not to the vehicle. Putting a speed rated tire on any vehicle does not mean the vehicle can be operated at the tire's rated speed.**
- **The speed rating is void if the tires are worn out, damaged, repaired, retreaded, or otherwise altered from their original condition. If tires are repaired, re-treaded, or otherwise altered, they may not be suitable for original equipment tire designed loads and speeds.**

▼ Tire Identification Number (TIN)
 Tire Identification Number (TIN) is marked on the intended outboard sidewall. The TIN is composed of four groups. Here is a brief review of the TIN with a breakdown of its

individual elements.

DOT XX XX XXX XXXX
 (1) (2) (3) (4)

- (1) Manufacturer's Identification Mark
- (2) Tire Size
- (3) Tire Type Code
- (4) Date of Manufacture

The first two figures identify the week, starting with "01" to represent the first full week of the calendar year; the second two figures represent the year. For example, 0101 means the 1st week of 2001.

▼ Other markings

The following markings are also placed on the sidewall.

▽ Maximum permissible inflation pressure

The maximum cold inflation pressure to which this tire may be inflated. For example, "300 kPa (44 PSI) MAX. PRESS".

13-4 Consumer information and Reporting safety defects

▽ Maximum load rating

The load rating at the maximum permissible weight load for this tire. For example, “MAX. LOAD 730 kg (1609 LBS) @ 300 kPa (44 PSI) MAX. PRESS.”



WARNING

Maximum load rating applies only to the tire, not to the vehicle. Putting a load rated tire on any vehicle does not mean the vehicle can be loaded up to the tire’s rated load.

▽ Construction type

Applicable construction of this tire. For example, “TUBELESS STEEL BELTED RADIAL”

▽ Construction

The generic name of each cord material used in the plies (both sidewall and tread area) of this tire. For example, “PLIES: TREAD 2

STEEL + 2 POLYESTER + 1 NYLON SIDEWALL 2 POLYESTER”

▽ Uniform Tire Quality Grading (UTQG)

For details, refer to “Uniform tire quality grading standards” in this chapter.

■ **Recommended tire inflation pressure**

▼ **Recommended cold tire inflation pressure**

Recommended cold tire inflation pressure for your vehicle's tires is as follows,

Tire size		P255/55R18 104H
Wheel size		18 × 8 JJ
Pressure	Front	33 psi (230 kPa, 2.3 kgf/cm ²)
	Rear	32 psi (220 kPa, 2.2 kgf/cm ²)
	Rear at trailer towing	32 psi (220 kPa, 2.2 kgf/cm ²)
Temporary spare tire	Size	T165/80R17
	Pressure	60 psi (420 kPa, 4.2 kgf/cm ²)

– CONTINUED –

▼ Vehicle placard

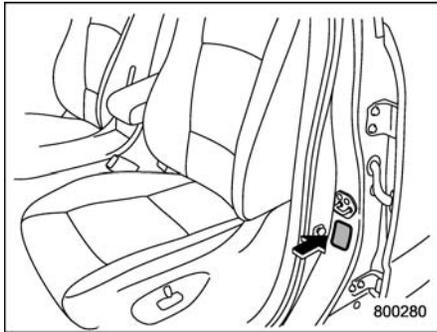

The vehicle placard is affixed to the driver's side B-pillar.

Example:

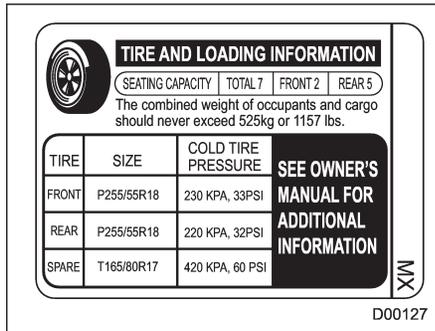

The vehicle placard shows original tire size, recommended cold tire inflation pressure on each tire at maximum loaded vehicle weight, seating capacity and loading information.

▼ Adverse safety consequences of under-inflation

Driving at high speeds with excessively low tire pressures can cause the tires to flex severely and to rapidly become hot. A sharp increase in temperature could cause tread separation, and failure of the tire(s). Possible resulting loss of vehicle control could lead to an accident.

▼ Measuring and adjusting air pressure to achieve proper inflation

Check and, if necessary, adjust the pressure of each tire (including the spare) at least once a month and before any long journey. Check the tire pressures when the tires are cold. Use a pressure gauge to adjust the tire pressures to the

specific values. Driving even a short distance warms up the tires and increases the tire pressures. Also, the tire pressures are affected by the outside temperature. It is best to check tire pressure outdoors before driving the vehicle. When a tire becomes warm, the air inside it expands, causing the tire pressure to increase. Be careful not to mistakenly release air from a warm tire to reduce its pressure.

■ Glossary of tire terminology

● Cold tire pressure

The pressure in a tire that has been driven less than 1 mile or has been standing for three hours or more.

● Maximum inflation pressure

The maximum cold inflation pressure to which a tire may be inflated.

● Recommended inflation pressure

The cold inflation pressure recommended by a vehicle manufacturer.

● Intended outboard sidewall

(1) The sidewall that contains a

whitewall, bears white lettering or bears manufacturer, brand, and/or model name molding that is higher or deeper than the same molding on the other sidewall of the tire, or

(2) The outward facing sidewall of an asymmetrical tire that has a particular side that must always face outward when mounting on a vehicle.

- **Accessory weight**

The combined weight (in excess of those standard items which may be replaced) of floor mats, leather seats and cross bars to the extent that these items are available as factory-installed equipment (whether installed or not).

- **Curb weight**

The weight of a motor vehicle with standard equipment including the maximum capacity of fuel, oil, and coolant and air conditioning.

- **Maximum loaded vehicle weight**

The sum of curb weight, accessory weight, vehicle capacity weight and

production options weight.

- **Normal occupant weight**

150 lbs (68 kg) times the number of occupants (3 occupants).

- **Occupant distribution**

Distribution of occupants in a vehicle, 2 in front, 1 in rear seat.

- **Production options weight**

The combined weight of those installed regular production options weighing over 5.1 lbs (2.3 kg) in excess of those standards items which they replace, not previously considered in curb weight or accessory weight.

- **Vehicle capacity weight**

The total weight of cargo, luggage and occupants that can be added to the vehicle.

- **Vehicle maximum load on a tire**

Load on an individual tire that is determined by distributing to each axle its share of the maximum loaded vehicle weight and dividing by two.

- **Vehicle normal load on a tire**

Load on an individual tire that is

determined by distributing to each axle its share of the curb weight, accessory weight, and normal occupant weight and dividing by two.

- **Tire care – maintenance and safety practices**

- Check on a daily basis that the tires are free from serious damage, nails, and stones. At the same time, check the tires for abnormal wear.

- Inspect the tire tread regularly and replace the tires before their tread wear indicators become visible. When a tire's tread wear indicator becomes visible, the tire is worn beyond the acceptable limit and must be replaced immediately. With a tire in this condition, driving at even low speeds in wet weather can cause the vehicle to hydroplane. Possible resulting loss of vehicle control can lead to an accident.

- To maximize the life of each tire and ensure that the tires wear uniformly, it is best to rotate the

13-8 Consumer information and Reporting safety defects

tires every 7,500 miles (12,000 km). Rotating the tires involves switching the front and rear tires on the right-hand side of the vehicle and similarly switching the front and rear tires on the left-hand side of the vehicle. (Each tire must be kept on its original side of the vehicle.) Replace any damaged or unevenly worn tire at the time of rotation. After tire rotation, adjust the tire pressures and make sure the wheel nuts are correctly tightened. A tightening torque specification and a tightening sequence specification for the wheel nuts can be found “Flat tires” in chapter 9.

■ Vehicle load limit – how to determine

The load capacity of your vehicle is determined by weight, not by available cargo space. The load limit of your vehicle is shown on the vehicle placard attached to the driver’s side B-pillar. Locate the statement “The combined weight

of occupants and cargo should never exceed XXX kg or XXX lbs” on your vehicle’s placard.

The vehicle placard also shows seating capacity of your vehicle.

The total load capacity includes the total weight of driver and all passengers and their belongings, any cargo, any optional equipment such as a trailer hitch, roof rack or bike carrier, etc., and the tongue load of a trailer. Therefore cargo capacity can be calculated by the following method.

Cargo capacity = Load limit – (total weight of occupants + total weight of optional equipment + tongue load of a trailer (if applicable))

For towing capacity information and weight limits, refer to the “Trailer towing” section in chapter 8.

▼ Calculating total and load capacities varying seating configurations

Calculate the available load capacity as shown in the following

examples:

Example 1A

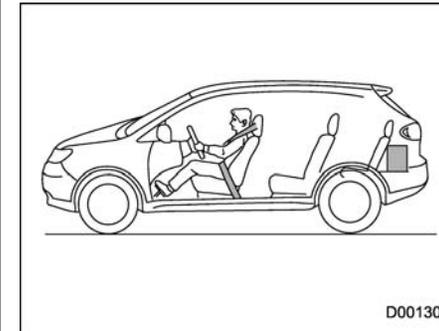

Vehicle capacity weight of the vehicle is 1,157 lbs (525 kg), which is indicated on the vehicle placard with the statement “The combined weight of occupants and cargo should never exceed 525 kg or 1,157 lbs”.

For example, if the vehicle has one occupant weighing 154 lbs (70 kg) plus cargo weighing 882 lbs (400 kg).

1. Calculate the total weight.

Total weight

$$= \frac{154 \text{ lbs (70 kg)}}{\text{(Occupant)}} + \frac{882 \text{ lbs (400 kg)}}{\text{(Cargo)}}$$

$$= \mathbf{1,036 \text{ lbs (470 kg)}}$$

2. Calculate the available load capacity by subtracting the total weight from the vehicle capacity weight of 1,157 lbs (525 kg).

Available Load Capacity

$$= \frac{1,157 \text{ lbs (525 kg)}}{\text{(Vehicle capacity weight)}} - \frac{1,036 \text{ lbs (470 kg)}}{\text{(Total weight)}}$$

$$= \mathbf{121 \text{ lbs (55 kg)}}$$

3. The result of step 2 shows that a further 121 lbs (55 kg) of cargo can be carried.

Example 1B

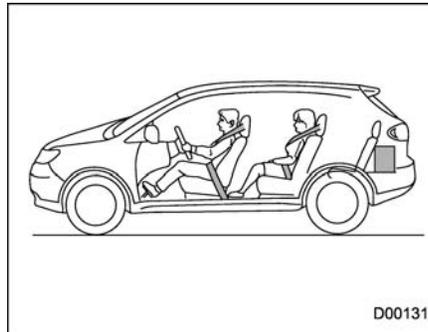

For example, if a person weighing 176 lbs (80 kg) now enters the same vehicle (bringing the number of occupants to two), the calculations are as follows:

1. Calculate the total weight.

Total weight

$$= \frac{154 \text{ lbs (70 kg)}}{\text{(Occupant)}} + \frac{882 \text{ lbs (400 kg)}}{\text{(Cargo)}}$$

$$= \mathbf{1,212 \text{ lbs (550 kg)}}$$

2. Calculate the available load capacity.

Available Load Capacity

$$= \frac{1,157 \text{ lbs (525 kg)}}{\text{(Vehicle capacity weight)}} - \frac{1,212 \text{ lbs (550 kg)}}{\text{(Total weight)}}$$

$$= \mathbf{-55 \text{ lbs (-25 kg)}}$$

3. The total weight now exceeds the capacity weight by 55 lbs (25 kg), so the cargo weight must be reduced by 55 lbs (25 kg) or more.

Example 2A

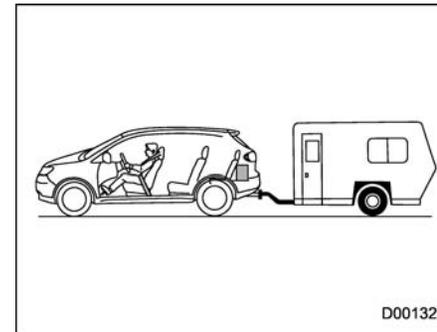

Vehicle capacity weight of the

13-10 Consumer information and Reporting safety defects

vehicle is 1,157 lbs (525 kg), which is indicated on the vehicle placard with the statement “The combined weight of occupants and cargo should never exceed 525 kg or 1,157 lbs”.

For example, the vehicle has one occupant weighing 165 lbs (75 kg) plus cargo weighing 705 lbs (320 kg). In addition, the vehicle is fitted with a trailer hitch weighing 22 lbs (10 kg), to which is attached a trailer weighing 1,764 lbs (800 kg). 10% of the trailer weight is applied to the trailer tongue (i.e. Tongue load = 176 lbs (80 kg)).

1. Calculate the total weight.

Total weight

$$\begin{aligned} &= \frac{165 \text{ lbs (75 kg)}}{\text{(Occupant)}} + \frac{705 \text{ lbs (320 kg)}}{\text{(Cargo)}} \\ &+ \frac{22 \text{ lbs (10 kg)}}{\text{(Trailer hitch)}} + \frac{176 \text{ lbs (80 kg)}}{\text{(Tongue load)}} \\ &= \mathbf{1,069 \text{ lbs (485 kg)}} \end{aligned}$$

2. Calculate the available load capacity.

Available Load Capacity

$$\begin{aligned} &= \frac{1,157 \text{ lbs}}{\text{(Vehicle capacity weight)}} - \frac{1,069 \text{ lbs}}{\text{(Total weight)}} \\ &= \mathbf{88 \text{ lbs (40 kg)}} \end{aligned}$$

3. The result of step 2 shows that a further 88 lbs (40 kg) of cargo can be carried.

Example 2B

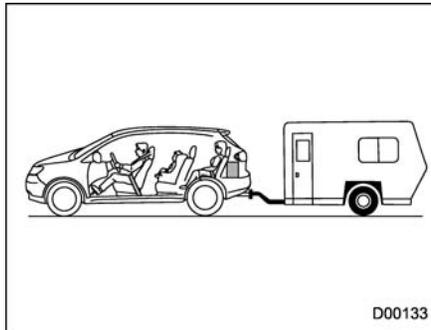

For example, if a person weighing 143 lbs (65 kg) and a child weighing

40 lbs (18 kg) now enter the same vehicle (bringing the number of occupants to three), and a child restraint system weighing 11 lbs (5 kg) is installed in the vehicle for the child to use, the calculations are as follows:

1. Calculate the total weight.

Total weight

$$\begin{aligned} &= \frac{165 \text{ lbs (75 kg)}}{\text{(Occupant)}} + \frac{143 \text{ lbs (65 kg)}}{\text{(Child restraint)}} + \frac{40 \text{ lbs (18 kg)}}{\text{(Cargo)}} \\ &+ \frac{11 \text{ lbs (5 kg)}}{\text{(Child restraint)}} + \frac{705 \text{ lbs (320 kg)}}{\text{(Cargo)}} \\ &+ \frac{22 \text{ lbs (10 kg)}}{\text{(Trailer hitch)}} + \frac{176 \text{ lbs (80 kg)}}{\text{(Tongue load)}} \\ &= \mathbf{1,263 \text{ lbs (573 kg)}} \end{aligned}$$

2. Calculate the available load capacity.

Available Load Capacity

$$= \frac{1,157 \text{ lbs}}{(525 \text{ kg})} - \frac{1,263 \text{ lbs}}{(573 \text{ kg})}$$

(Vehicle capacity weight) (Total weight)

= -105 lbs (-48 kg)

3. The total weight now exceeds the capacity weight by 105 lbs (48 kg), so the cargo weight must be reduced by 105 lbs (48 kg) or more.

■ **Determining compatibility of tire and vehicle load capacities**

The sum of four tires' maximum load ratings must exceed the maximum loaded vehicle weight ("GVWR"). In addition, sum of the maximum load ratings of two front tires and of two rear tires must exceed each axle's maximum loaded capacity ("GAWR"). Original equipment tires are designed to fulfill those conditions.

The maximum loaded vehicle weight is referred to Gross Vehicle

Weight Rating (GVWR). And each axle's maximum loaded capacity is referred to Gross Axle Weight Rating (GAWR). The GVWR and each axle's GAWR are shown on the vehicle certification label affixed to the driver's door.

The GVWR and front and rear GAWRs are determined by not only the maximum load rating of tires but also loaded capacities of the vehicle's suspension, axles and other parts of the body.

Therefore, this means that the vehicle cannot necessarily be loaded up to the tire's maximum load rating on the tire sidewall.

■ **Adverse safety consequences of overloading on handling and stopping and on tires**

Overloading could affect vehicle handling, stopping distance, vehicle and tire as shown in the following. This could lead to an accident and possibly result in severe personal

injury.

- Vehicle stability will deteriorate.
- Heavy and/or high-mounted loads could increase the risk of rollover.
- Stopping distance will increase.
- Brakes could overheat and fail.
- Suspension, bearings, axles and other parts of the body could break or experience accelerated wear that will shorten vehicle life.
- Tires could fail.
- Tread separation could occur.
- Tire could separate from its rim.

■ **Steps for Determining Correct Load Limit**

1. Locate the statement "The combined weight of occupants and cargo should never exceed XXX pounds" on your vehicle's placard.
2. Determine the combined weight of the driver and passengers that will be riding in your vehicle.
3. Subtract the combined weight of the driver and passengers from XXX kilograms or XXX pounds.

- CONTINUED -

4. The resulting figure equals the available amount of cargo and luggage load capacity. For example, if the “XXX” amount equals 1,400 lbs (635 kg) and there will be five- 150 lbs (68 kg) passengers in your vehicle, the amount of available cargo and luggage load capacity is 650 lbs. $(1,400 - 750 (5 \times 150) = 650 \text{ lbs})$.

5. Determine the combined weight of luggage and cargo being loaded on the vehicle. That weight may not safely exceed the available cargo and luggage load capacity calculated in Step 4.

6. If your vehicle will be towing a trailer, load from your trailer will be transferred to your vehicle. Consult this manual to determine how this reduces the available cargo and luggage load capacity of your vehicle.

Uniform tire quality grading standards

This information indicates the relative performance of passenger car tires in the area of treadwear, traction, and temperature resistance. This is to aid the consumer in making an informed choice in the purchase of tires.

Quality grades can be found where applicable on the tire sidewall between tread shoulder and maximum section width. For example:

Treadwear 200 Traction AA Temperature A

The quality grades apply to new pneumatic tires for use on passenger cars. However, they do not apply to deep tread, winter type snow tires, space-saver or temporary use spare tires, tires with nominal rim diameters of 12 inches or less, or to some limited production tires.

All passenger car tires must con-

form to Federal Safety Requirements in addition to these grades.

■ Treadwear

The treadwear grade is a comparative rating based on the wear rate of the tire when tested under controlled conditions on a specified government test course.

For example, a tire graded 150 would wear one and one-half (1-1/2) times as well on the government course as a tire graded 100. The relative performance of tires depends upon the actual conditions of their use, however, and may depart significantly from the norm due to variations in driving habits, service practices and differences in road characteristics and climate.

■ Traction AA, A, B, C

The traction grades, from highest to lowest, are AA, A, B and C. Those grades represent the tire's ability to stop on wet pavement as measured under controlled conditions on spe-

cified government test surfaces of asphalt and concrete. A tire marked C may have poor traction performance.

 **WARNING**

The traction grade assigned to this tire is based on straight-ahead braking traction tests, and does not include acceleration, cornering, hydroplaning, or peak traction characteristics.

■ **Temperature A, B, C**

The temperature grades are A (the highest), B, and C, representing the tire's resistance to the generation of heat and its ability to dissipate heat when tested under controlled conditions on a specified indoor laboratory test wheel. Sustained high temperature can cause the material of the tire to degenerate and reduce tire life, and excessive temperature can lead to sudden tire failure. The

grade C corresponds to a level of performance which all passenger car tires must meet under the Federal Motor Vehicle Safety Standards No. 109. Grades B and A represent higher levels of performance on the laboratory test wheel than the minimum required by law.

 **WARNING**

The temperature grade for this tire is established for a tire that is properly inflated and not overloaded. Excessive speed, underinflation, or excessive loading, either separately or in combination, can cause heat buildup and possible tire failure.

Reporting safety defects (U.S.A.)

If you believe that your vehicle has a defect which could cause a crash or could cause injury or death, you should immediately inform the National Highway Traffic Safety Administration (NHTSA) in addition to notifying Subaru of America, Inc.

If NHTSA receives similar complaints, it may open an investigation, and if it finds that a safety defect exists in a group of vehicles, it may order a recall and remedy campaign. However, NHTSA cannot become involved in individual problems between you, your dealer, or Subaru of America, Inc. To contact NHTSA, you may call the Vehicle Safety Hotline toll-free at 1-888-327-4236 (TTY: 1-800-424-9153); go to <http://www.safercar.gov>; or write to: Administrator, NHTSA, 400 Seventh Street, SW., Washington,

DC 20590. You can also obtain other information about motor vehicle safety from <http://www.safercar.gov>.

14-2 Index

A

ABS (Anti-lock Brake System)	7-20
Warning light	3-15, 7-21
Accessories	5-4, 11-40
Accessory power outlet	6-9
Active head restraint	1-5
Air cleaner element	11-14
Air filtration system	4-11
Air flow	4-2
Air flow mode selection	4-3
Alarm system	2-15
All-Wheel Drive warning light	3-18
Aluminum wheel cleaning	10-3
Aluminum wheels	11-30
Antenna system	5-2
Anti-lock Brake System (ABS)	7-20
Arming the system	2-16
Armrest	1-12
AT OIL TEMP warning light	3-13
Audio control button	5-27
Audio input jack	5-29
Audio set	5-4
Auto-dimming mirror/compass	3-38
Automatic climate control system	4-5
Automatic transmission	7-12
Capacities	12-3
Fluid	11-15
MANUAL mode	7-15
Selector lever	7-13
Shift lock release	7-17
SPORT mode	7-17

Temperature warning light (AT OIL TEMP)	3-13
Automatic/Emergency Locking Retractor (A/ELR)	1-17
AUX unit operation	5-29

B

Battery	11-37
Jump starting	9-12
Replacement (remote keyless entry system)	2-10
Booster seat	1-37
Brake	
Assist	7-19
Booster	7-19, 11-21
Fluid	11-20
Pad and lining	11-22
Parking	7-29, 11-23
Pedal	11-21
System	7-19
Brake pedal	
Free play	11-21
Reserve distance	11-22
Brake system	7-19
Warning light	3-16
Braking	7-18
Tips	7-18
Breaking-in of new brake pads and linings	11-22
Bulb	
Chart	12-8
Replacing	11-41

C

Capacities	12-3
------------------	------

- Cargo area
 - Cover 6-13
 - Light..... 6-2
 - Tie-down hooks 6-15
- Catalytic converter 8-3
- Center
 - Console 6-6
 - Ventilators 4-4
- Changing
 - Flat tire 9-6
 - Oil and oil filter 11-8
- Charge warning light 3-13
- CHECK ENGINE warning light/Malfunction indicator lamp..... 3-12
- Checking
 - Brake pedal free play 11-21
 - Brake pedal reserve distance 11-22
 - Engine oil level 11-7
 - Fluid level 11-15, 11-19, 11-20
 - Gear oil level 11-18
- Child restraint systems 1-31
 - Installation with A/ELR seatbelt..... 1-34
 - Lower and tether anchorages 1-38
 - Top tether anchorages 1-41
- Child safety 5
 - Locks 2-19
- Chime
 - Key 3-4
 - Seatbelt 1-18, 3-10
- Chrome plated wheels 11-31
- Cleaning
 - Aluminum wheels 10-3
 - Interior 10-5
 - Ventilation grille 4-10
- Climate control system
 - Automatic 4-5
- Clock 3-21
- Coat hook..... 6-11
- Coolant 11-11
- Cooling system 11-11
- Corrosion protection..... 8-10, 10-4
- Cruise control 7-30
 - Indicator light 3-20, 7-33
 - Set indicator light..... 3-21, 7-33
- Cup holder 6-7
 - Front passenger's..... 6-7
 - Rear seat (5-seater models)/Second-row seat (7-seater models) passenger's..... 6-8
 - Third-row seat (7-seater models) 6-8
- D**
 - Daytime running light system 3-27
 - Differential gear oil
 - Front..... 11-17
 - Rear 11-18
 - Dimensions..... 12-2
 - Disarming the alarm system..... 2-17
 - Disc brake pad wear warning indicators 7-19
 - Dome light 6-2, 11-48
 - Door
 - Locks..... 2-4

14-4 Index

Open warning light	3-17
Step light	11-50
Drive belts.....	11-15
Driving	
All-Wheel Drive warning light.....	3-18
Car phone/cell phone	7
Drinking.....	6
Drugs	6
Foreign countries	8-4
Pets	7
Snowy and icy roads.....	8-9
Tips.....	8-4
Tired or sleepy.....	7
E	
Electrical system.....	12-3
Electronic Brake Force Distribution (EBD) system.....	3-17, 7-22
Emergency Locking Retractor (ELR).....	1-17
Engine	
Compartment overview	11-6
Coolant.....	11-11
Exhaust gas (carbon monoxide).....	5, 8-2
Hood	11-4
Oil.....	11-7
Overheating	9-14
Starting.....	7-7
Stopping	7-8
Exterior care.....	10-2

F	
Flat tires	9-6
Floor mat.....	6-12
Fluid level	
Automatic transmission	11-15
Brake.....	11-20
Power steering	11-19
Fog light	
Bulb.....	11-45
Indicator light	3-21
Switch.....	3-32
Folding mirror switch.....	3-41
Front	
Differential gear oil.....	11-17
Fog light (bulb).....	11-45
Seatbelt pretensioners	1-28
Seats	1-2
Turn signal light.....	11-45
Front fog light.....	3-32
Indicator light	3-21
Front seats	
Forward and backward adjustment	1-3
Reclining	1-3
Fuel	7-2
Economy hints	8-2
Filler lid and cap.....	7-3
Gauge.....	3-8
Requirements	7-2
Fuses	11-38
Fuses and circuits	12-5

G

- GAWR (Gross Axle Weight Rating) 8-12
- Glove box 6-5
- GVWR (Gross Vehicle Weight Rating) 8-12

H

- Hazard warning flasher 3-5, 9-2
- Head restraint adjustment
 - Front seat 1-5
 - Rear (5-seater models)/Second-row
(7-seater models) 1-11
 - Third-row 1-15
- Headlight
 - Beam leveler 3-29
 - Flasher 3-27
 - Indicator light 3-21
- Headlights 3-26, 11-42
- High beam indicator light 3-20
- High/low beam change (dimmer) 3-27
- Horn 3-42
- Hose and connections 11-11

I

- Ignition switch 3-3
 - Light 3-4
- Illuminated entry 2-9
- Illumination brightness control 3-28
- Immobilizer 2-3
 - Indicator light (security indicator light) 2-4, 3-19
- Indicator light
 - Cruise control 3-20, 7-33

- Cruise control set 3-21, 7-33
- Front fog light 3-21
- Headlight 3-21
- High beam 3-20
- Immobilizer 2-4
- Security 2-4, 3-19
- Selector lever/Gear position 3-20
- SPORT mode 3-20
- Traction control system OFF 3-18, 7-25
- Turn signal 3-20
- Vehicle Dynamics Control operation 3-18, 7-25
- Inside mirror 3-38
- Interior lights 6-2

J

- Jack and jack handle 9-19
- Jump starting 9-12

K

- Key
 - Number 2-2
 - Reminder chime 3-4
 - Replacement 2-4
- Keyless entry system 2-8
- Keys 2-2

L

- Leather seat materials 10-5
- License plate light 11-47
- Light
 - Back-up (Station wagon) 11-47

14-6 Index

Cargo area.....	6-2, 11-50
Control switch.....	3-26
Dome	6-2, 11-48
Door step.....	11-50
Front fog.....	3-32
Ignition switch.....	3-4
License plate.....	11-47
Map	6-3, 11-49
Rear combination.....	11-46
Rear gate.....	6-3
Vanity mirror.....	6-4
Vanity Mirror.....	11-49
Loading your vehicle	8-11
Low fuel warning light.....	3-8, 3-17
Low tire pressure warning light	3-14
Lower and tether anchorage.....	1-38
Lumbar support	1-6
M	
Main fuse.....	11-39
Maintenance	
Precautions.....	11-3
Schedule	11-3
Seatbelt	1-27
Tools	9-19
Malfunction indicator lamp (check engine warning light).....	3-12
Map light.....	6-3, 11-49
Maximum load limits.....	8-20
Meters and gauges	3-5
Mirrors.....	3-38
Moonroof.....	2-24
Multi function display.....	3-23
N	
New vehicle break-in driving	8-2
O	
Odometer	3-6
Oil filter	11-8
Oil level	
Engine	11-7
Front differential gear.....	11-17
Rear differential.....	11-18
Oil pressure warning light	3-13
On-pavement and off road driving.....	8-5
Outside mirrors	3-39
Outside temperature indication	3-22
Overhead console	6-7
Overheating engine	9-14
P	
Parking	
Brake.....	7-29
Brake stroke	11-23
Light	11-44
Light switch	3-32
Tips	7-29
Parking your vehicle	7-29
Periodic inspections.....	8-4
Petrol fuel.....	7-2

- Power
- Door locking switch 2-6
 - Outside mirrors 3-41
 - Seat 1-3
 - Steering 7-18
 - Steering fluid 11-19
 - Windows 2-20
- Precautions against vehicle modification 1-30, 1-70
- Preparing to drive 7-7
- Printed antenna 5-2
- R**
- Rear
- Air conditioner 4-8
 - Combination lights 11-46
 - Gate 2-22, 9-18
 - Gate light 6-3, 11-47
 - Seats 1-7
- Rear differential
- Gear oil 11-18
 - Oil temperature warning light 3-14
- Rear seat
- Folding down 1-9
 - Reclining 1-9
- Rear turn signal 11-46
- Rear view camera 6-21
- Rear window
- Defogger button 3-37
 - Wiper and washer switch 3-35
 - Wiper blades 11-35
- Recommended
- Automatic transmission fluid 11-16
 - Brake fluid 11-21
 - OIL grade and viscosity 11-9, 11-10, 11-17, 11-18
 - Power steering fluid 11-20
 - Spark plugs 11-15
- Refueling 7-3
- Remote engine start system 7-8
- Remote keyless entry system 2-8
- Replacement
- Brake pad and lining 11-22
 - Wiper blades 11-33
- Replacing
- Air cleaner element 11-14
 - Battery (remote keyless entry system) 2-10
 - Lost transmitters (remote keyless entry system) 2-12
- Replacing bulbs 11-41
- Back-up light (Station wagon) 11-47
 - Back-up light/Tail light 11-47
 - Cargo area light 11-50
 - Dome light 11-48
 - Door step light 11-50
 - Front fog light 11-45
 - Front turn signal light 11-45
 - Headlight 11-42
 - License plate light 11-47
 - Map light 11-49
 - Parking light 11-44
 - Rear combination light 11-46
 - Rear gate light 11-47
 - Vanity mirror light 11-49

14-8 *Index*

Rocking the vehicle	8-11
Roof molding and crossbar	8-16
Roof rail and crossbar	8-13
S	
Safety	
Precautions when driving	4
Symbol	2
Warnings	2
Seat	
Fabric	10-5
Heater	1-6
Memory function	1-4
Seatbelt	4
Maintenance	1-27
Pretensioners	1-28
Safety tips	1-16
Warning light and chime	1-18, 3-10
Seatbelts	1-16
Security ID plate	2-3
Security indicator light	2-4, 3-19
Selector lever	7-13
Position indicator	3-20
Shift lock release	7-17
Shock sensors	2-19
Shopping bag hook	6-12
Snow tires	8-10, 11-24
Snowy and icy roads	8-9
Sounding a panic alarm	2-10
Spare tire	9-2
Spark plugs	11-15

Specifications	12-2
Speedometer	3-6
SPORT mode	7-17
SPORT mode indicator light	3-20
SRS	
Curtain airbag	1-58
Frontal airbag	1-48
Side airbag	1-58
SRS airbag (Supplemental Restraint System airbag) ...	4, 1-44
SRS airbag system	
Monitors	1-69
Servicing	1-70
Warning light	3-11
Starting the engine	7-7
State emission testing (U.S. only)	7-5
Steering wheel	
Power	7-18
Tilt	3-41
Stopping the engine	7-8
Storage compartment	6-5
Sun shade	2-25
Sun visors	6-4
Supplemental Restraint System airbag (SRS)	1-44
Synthetic leather upholstery	10-5
T	
Tachometer	3-7
Temperature gauge	3-9
Temperature warning light	
AT OIL TEMP	3-13
Rear differential oil	3-14

- Temporary spare tire 9-5
- Tether (child restraint system) 1-38, 1-41
- Tie-down hooks 9-15
- Tilt steering wheel 3-41
- Tire
 - Chains 8-11
 - Inspection 11-25
 - Pressures and wear 11-25
 - Replacement 11-29
 - Rotation 11-28
 - Types 11-23
- Tire pressure monitoring system (TPMS) 3-14, 7-27, 9-11, 11-24
- Tires 12-3
- Tires and wheels 11-23
- Top tether anchorages 1-38, 1-41
- Towing 9-15
 - All wheels on the ground 9-18
 - Flat-bed truck 9-17
 - Tie-down hooks 9-15
 - Weight 8-20
- Traction Control system
 - OFF indicator light 3-18, 7-25
 - OFF switch 7-26
- Trailer
 - Connecting 8-18
 - Hitch 8-18
 - Hitches 8-23
 - Towing 8-20
 - Towing tips 8-26
- Trip meter 3-7
- Turn signal
 - Indicator lights 3-20
 - Lever 3-28
- U**
 - Under-floor storage compartment 6-15
- V**
 - Valet mode 2-17
 - Vanity mirror
 - Light 11-49
 - Vehicle
 - Capacity weight 8-12
 - Identification 12-9
 - Symbols 3
 - Vehicle Dynamics Control
 - Operation indicator light 3-18, 7-25
 - System 7-23
 - Warning light 3-18, 7-25
 - Ventilator 4-2
- W**
 - Warning and indicator lights 3-9
 - Warning light
 - ABS 3-15, 7-21
 - All-Wheel Drive 3-18
 - AT OIL TEMP 3-13
 - Brake system 3-16
 - Charge 3-13
 - CHECK ENGINE 3-12
 - Door open 3-17

14-10 Index

Low fuel.....	3-8, 3-17
Low tire pressure	3-14
Oil pressure	3-13
Rear differential oil temperature	3-14
Seatbelt.....	1-18, 3-10
SRS airbag system	3-11
Vehicle Dynamics Control	3-18, 7-25
Windshield washer fluid	3-18
Warranties	1
Warranties and maintenance	8-20
Washing	10-2
Waxing and polishing	10-3
Wear indicators.....	11-28
Wheel	
Alignment.....	12-4
Aluminum.....	11-30
Balance	11-27
Chrome plated wheels	11-31
Replacement.....	11-29
Windows	2-20
Windshield	
Washer fluid	11-32
Wiper and washer switches.....	3-34
Wiper blades	11-33
Wiper deicer.....	3-36
Winter	
Driving.....	8-7
Tires.....	8-10, 11-24
Winter tire	8-10, 11-24
Wiper and washer.....	3-33

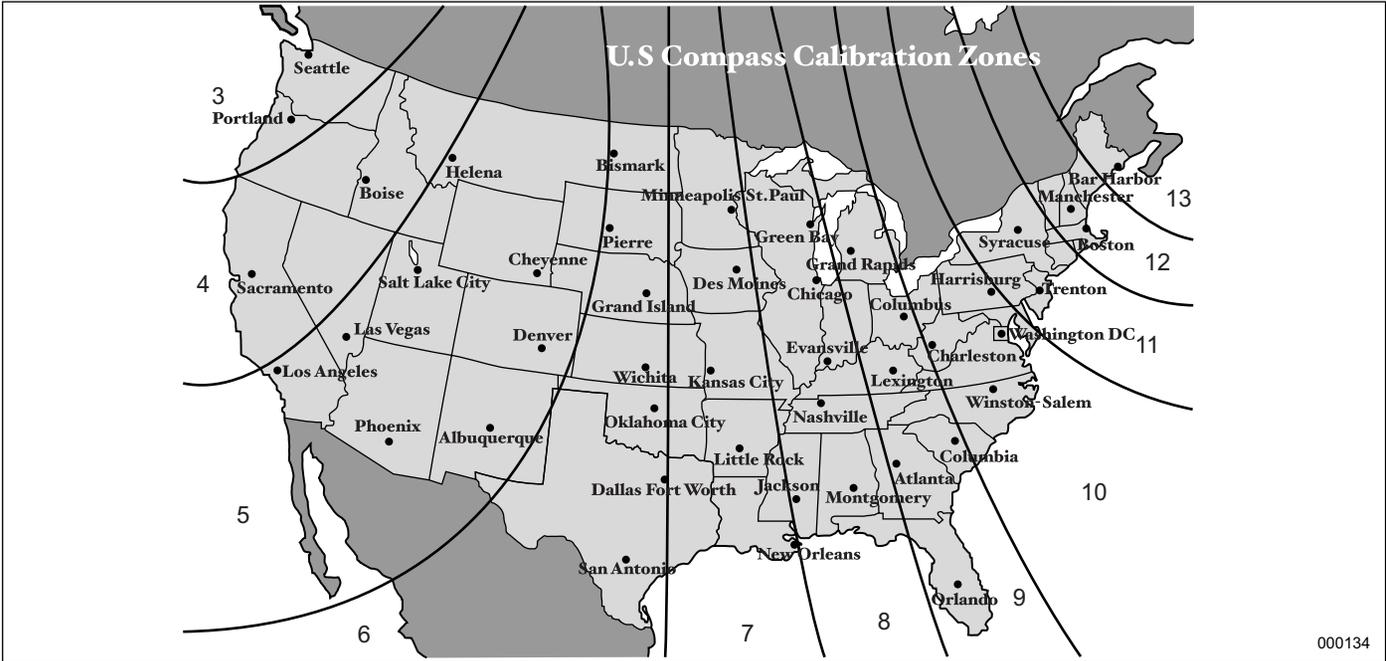

GAS STATION REFERENCE

■ Fuel

Use unleaded gasoline with an octane rating of 87 AKI or higher.

■ Fuel octane rating

This octane rating is the average of the Research Octane and Motor Octane numbers and is commonly referred to as the Anti Knock Index (AKI). Refer to “Fuel” section in this manual.

■ Fuel capacity

16.9 US gal (64 liters, 14.1 Imp gal)

■ Engine oil

Use only API classification SM with the words “ENERGY CONSERVING” and the ILSAC certification mark (starburst mark) displayed on the container.

■ Engine oil capacity

6.7 US qt (6.3 liters, 5.5 Imp qt)

■ Cold tire pressure

Tire size		P255/55R18 104H
Wheel size		18 × 8JJ
Pressure	Front	33 psi (230 kPa, 2.3 kgf/cm ²)
	Rear	32 psi (220 kPa, 2.2 kgf/cm ²)
	Rear at trailer towing	32 psi (220 kPa, 2.2 kgf/cm ²)
Temporary spare tire	Size	T165/80R17
	Pressure	60 psi (420 kPa, 4.2 kgf/cm ²)