

Canister

EMISSION CONTROL (AUX. EMISSION CONTROL DEVICES)

5. Canister

A: REMOVAL

- 1) Disconnect the ground cable from battery.
- 2) Lift up the vehicle.
- 3) Remove the clip holding the harness.

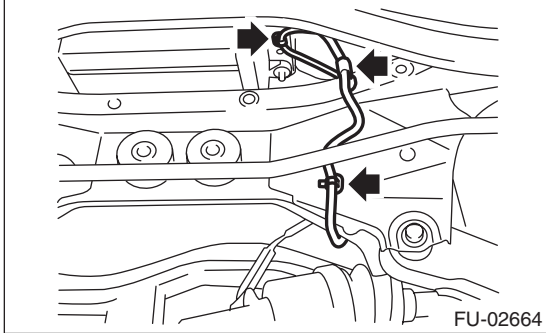

- 4) Remove the rear suspension assembly. <Ref. to RS-18, REMOVAL, Rear Sub Frame.>
- 5) Disconnect the purge hose (A), air vent hose (B) and drain hose (C).

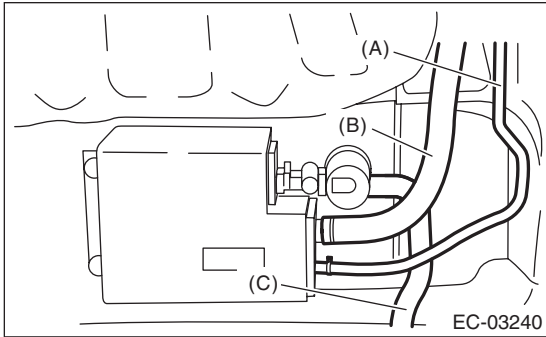

- 6) Remove the canister from body.

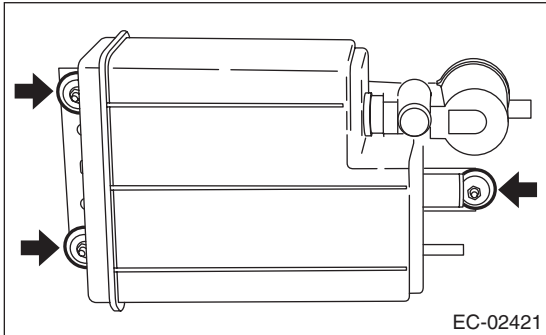

B: INSTALLATION

Install in the reverse order of removal.

Tightening torque:

8 N·m (0.8 kgf-m, 5.9 ft-lb)

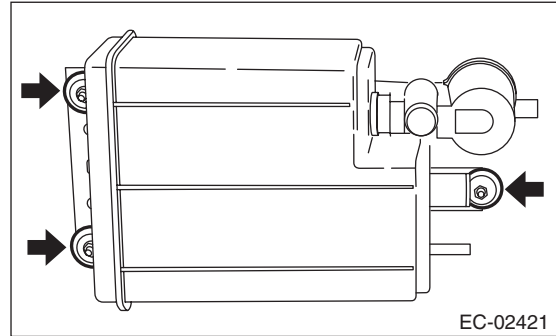

C: INSPECTION

Check that the canister has no deformation, cracks or other damages.