

# FORESTER

## 2016 Quick Reference Guide



**SUBARU**

*Confidence in Motion*



**For detailed operating and safety information, please refer to your Owner's Manual.**

## BASIC OPERATION

### Lock/Unlock doors

#### Remote keyless entry system

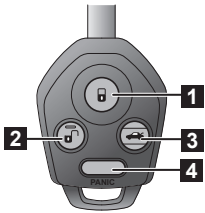

Remote transmitter key (if equipped)



Access key (if equipped)

- 1 All doors will be locked.
- 2 The driver's door will be unlocked. (To unlock all doors, briefly press the button a second time within 5 seconds.)
- 3 Press the button to open the rear gate.
- 4 The horn will sound and the hazard warning flashes will flash.

#### Keyless access function (if equipped)

All doors and the rear gate will be locked/unlocked by the following procedures carrying the access key on your person. (The driver should always carry the access key.)

##### Side door (front door handles only):

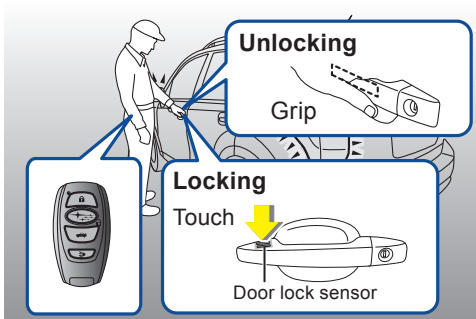

##### Rear gate:

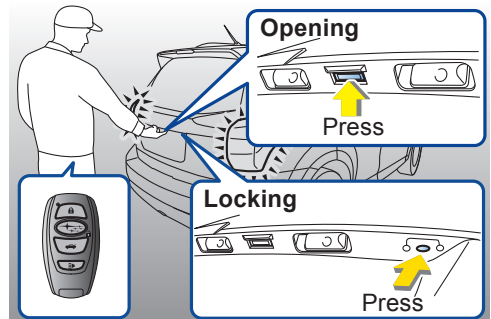

## Adjustable components

### Front seat

Power seat (driver's seat - if equipped):

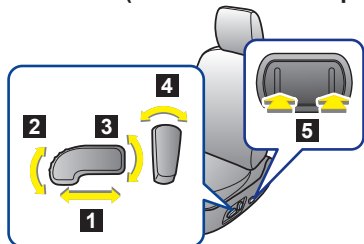

- 1 Forward and backward adjustment
- 2 Seat cushion angle adjustment
- 3 Seat height adjustment
- 4 Seatback reclining
- 5 Lumbar support control

Manual seat (if equipped):

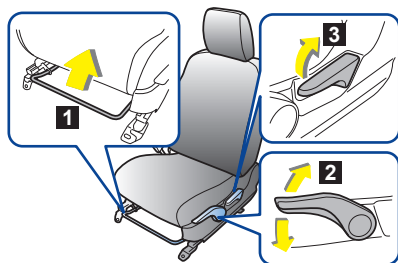

- 1 Forward and backward adjustment
- 2 Seat height adjustment (driver's seat only)
- 3 Seatback reclining adjustment

### Tilt/telescopic steering wheel

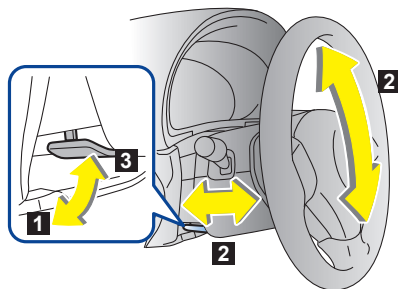

- 1 Pull the tilt/telescopic lock lever down.
- 2 Move the steering wheel to the desired level.
- 3 Pull the lever up to lock the steering wheel in place.

Make sure that the steering wheel is securely locked by moving it up and down, and forward and backward.

### Remote control mirror switch

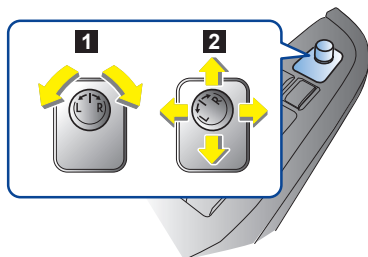

Ignition switch must be in **ACC** or **ON** position.

- 1 Select side to adjust.
- 2 To adjust the mirror, move the switch in the direction of your desired position.

## Start/Stop engine

### Push-button ignition switch (if equipped)

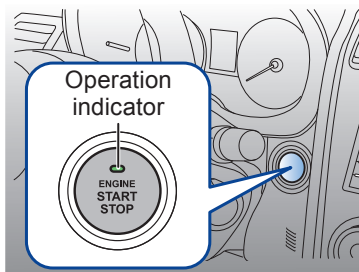

#### To start engine:

- 1: Carry the access key, and sit in the driver's seat.
- 2: Apply the parking brake.
- 3: Shift the select lever in the **P** position.
- 4: Depress the brake pedal until the indicator on the push-button ignition switch turns green.
- 5: While depressing the brake pedal, press the push-button ignition switch.

#### To stop engine:

- 1: Stop the vehicle completely.
- 2: Move the select lever to the **P** position.
- 3: Apply the parking brake.
- 4: Press the push-button ignition switch.

Every time the button is pressed without depressing the brake pedal, the power is switched in the sequence of **OFF→ACC→ON→OFF**.

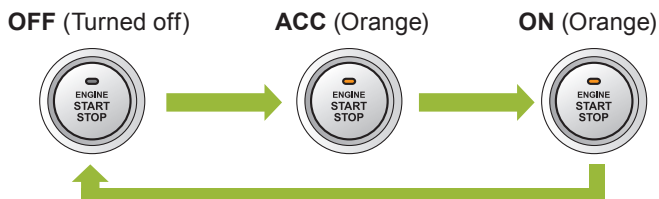

### Ignition switch (if equipped)

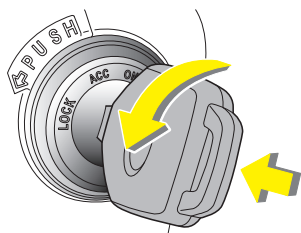

The key can be turned from **ACC** to **LOCK** only when the select lever is in the **P** position (CVT models) and the key is pushed in while turning it (all models).

## Operate Select lever/Shift lever

### Continuously variable transmission (if equipped)

Select lever button

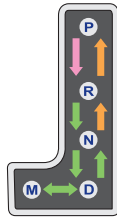
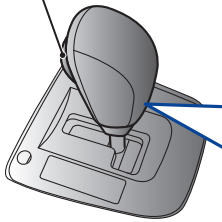

- With the brake pedal depressed, shift while pressing the button in
- Shift while pressing the button in
- Shift without pressing the button

Models with Manual mode

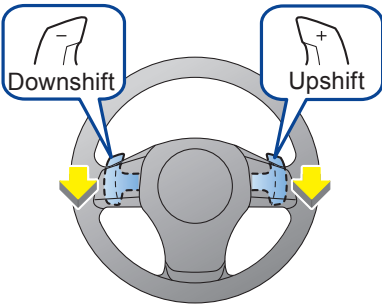

#### **M = Manual mode:**

With the vehicle either moving or stationary, move the select lever from the **D** position to the **M** position to select the manual mode.

#### **Shift paddle:**

Gearshifts can be performed using the shift paddle behind the steering wheel.

### Manual transmission (if equipped)

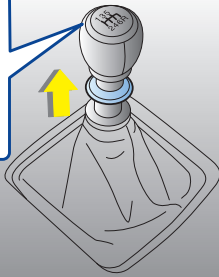
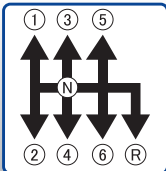

You must raise the slider and hold it in that position before you can move the shift lever to the **R** position. To change gears, fully depress the clutch pedal, move the shift lever, and gradually let up on the clutch pedal.

# DRIVER'S AREA

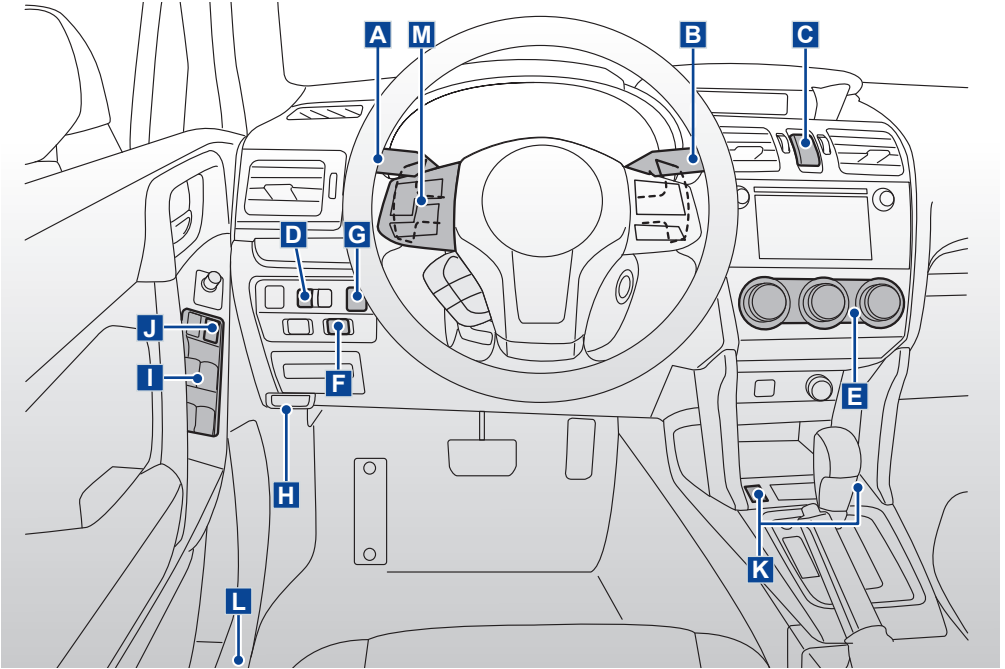

## A Headlight switch/Turn signal lever/Fog light switch (if equipped)

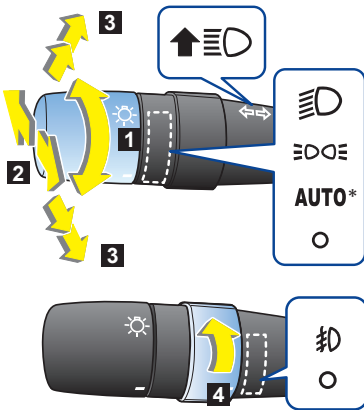

- 1 Headlights
- 2 Headlight flasher, High/Low beam change (dimmer)
- 3 Turn signal
- 4 Front fog lights (if equipped)

To turn on, rotate dial to . Front fog lights operate only when headlight switch is in:

- or position.
- **AUTO** position and the headlights are on.

\* For models equipped with AUTO position.

## B Wiper and washer switch

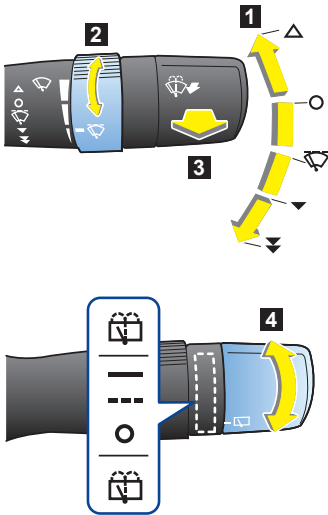

### 1 Windshield wiper

To operate the wiper, rotate knob to;

- △ : Mist (for a single wipe)
- : Off
- ⏸ : Intermittent
- ▼ : Low speed
- ▼▼ : High speed

### 2 Wiper intermittent time control

### 3 Windshield washer

Pull the wiper control lever toward you.

### 4 Rear window wiper and washer

To operate the wiper, rotate knob to;

- : Continuous
- - - : Intermittent
- : Off
- ⊞ : Washer (accompanied by wiper operation)

## C Hazard warning flasher switch

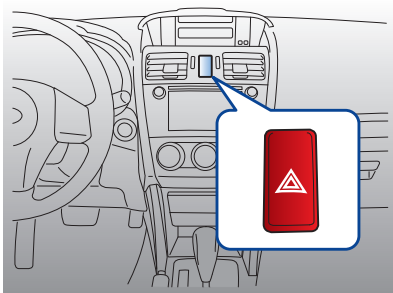

To turn on the hazard warning flasher, press the button.

Use in emergency conditions.

## D Illumination brightness control dial

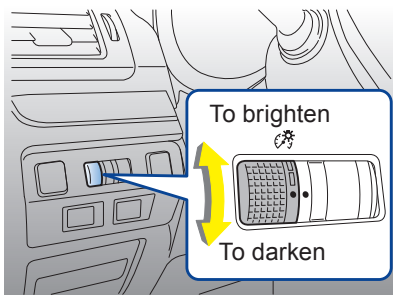

Turn the dial to adjust the illumination brightness of the instrument panel.

When the control dial is turned fully upward to ● position, the illumination brightness becomes the maximum and the automatic dimming function does not work at all.

## E Defroster button/Rear window defogger button

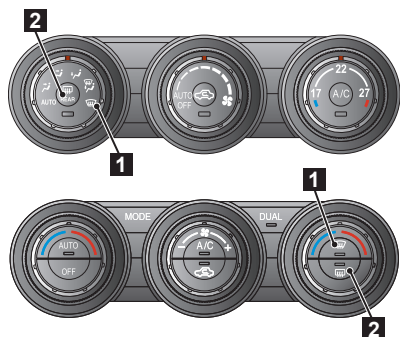

**1 Defroster button:**  
Press the button or turn the dial to defrost the windshield.

**2 Rear window defogger button:**  
Press the button to turn on rear window defogger, outside mirror defogger and windshield wiper deicer (if equipped). The function will automatically shut off after approximately 15 minutes.

## F Power rear gate switch (if equipped)

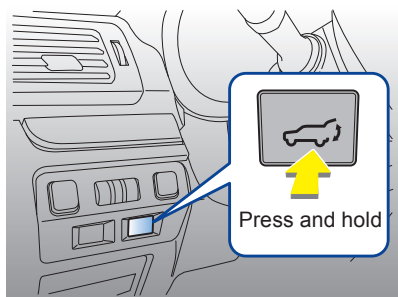

## G Memory switch (if equipped)

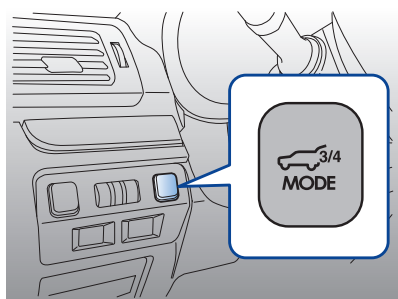

Your desired rear gate height can be registered.



## H Hood lock release knob

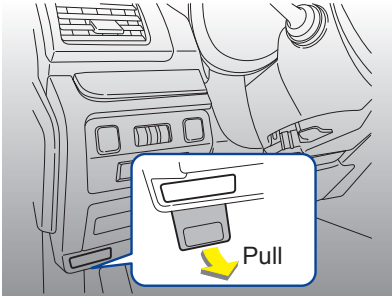

## I Power window switches

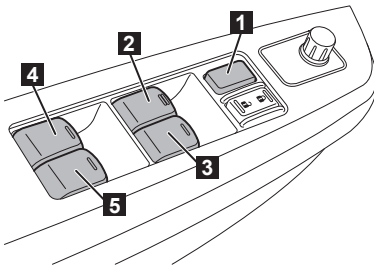

- 1** Lock switch
- 2** For driver's window
- 3** For front passenger's window
- 4** For rear left passenger's window
- 5** For rear right passenger's window

## J Power door locking switch

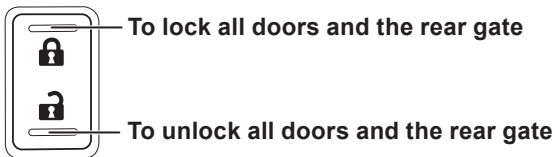

## K Seat heater switches

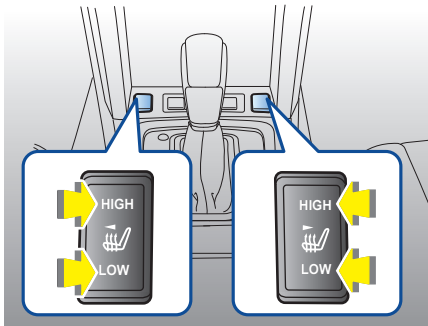

**HIGH:** Rapid heating

**LOW:** Normal heating

## L Fuel filler lid release lever

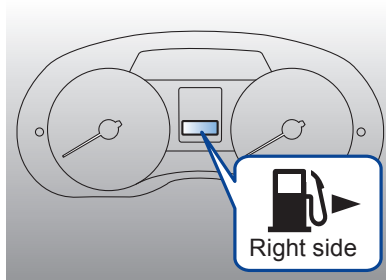
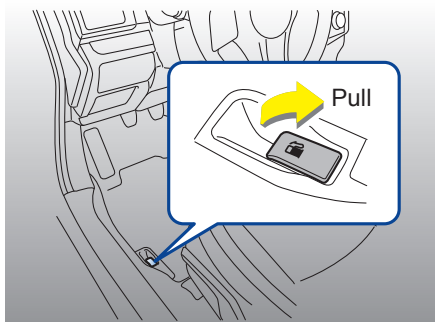

This indicates that the fuel filler door (lid) is located on the right side of the vehicle.

## M Audio control buttons

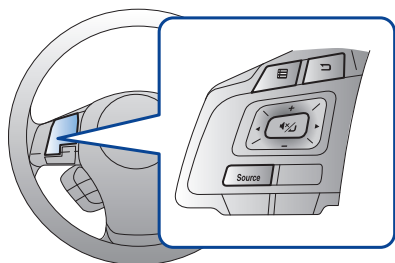

These buttons allow the driver to control audio functions without taking his/her hands off the steering wheel.

## Moonroof switch (if equipped)

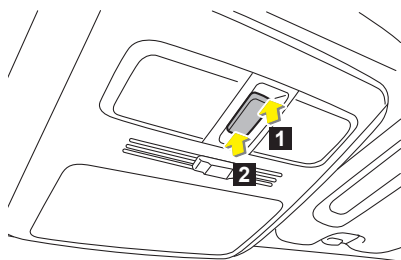

- 1 Open
- 2 Close

## Child safety locks

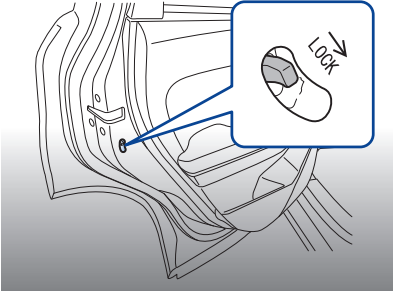

Located on the edge of each rear door.  
When the lever is in the **LOCK** position, the rear door cannot be opened from the inside.

## Front seat shoulder belt anchor height

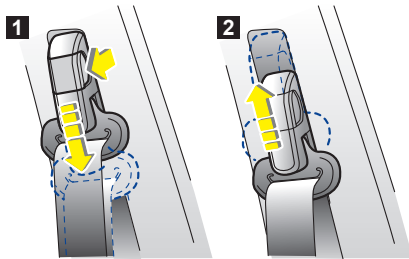

- 1 To lower:**  
Pull the release lever and slide the anchor down.
- 2 To raise:**  
Slide the anchor up.

# VEHICLE PERFORMANCE FUNCTIONS

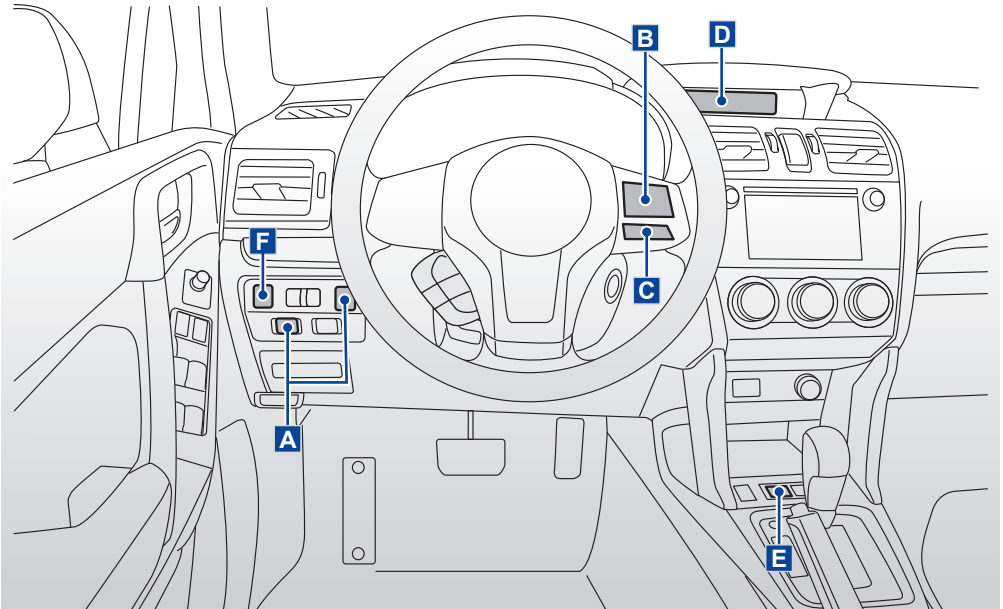

## A Vehicle Dynamics Control OFF switch

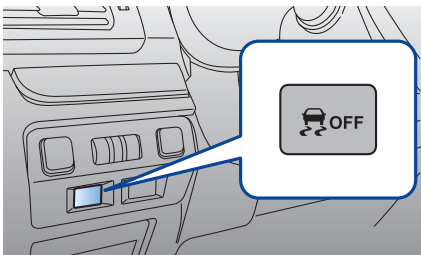

models with power rear gate

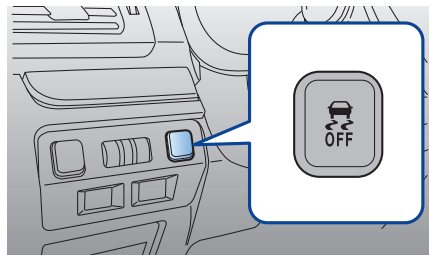

models without power rear gate

## Indicator lights on the combination meter



**Vehicle Dynamics Control mode**



**Vehicle Dynamics Control OFF mode**

Deactivating the Vehicle Dynamics Control system facilitates the following operations:

- a standing start on a steeply sloping road with a snowy, gravel-covered, or otherwise slippery surface
- extrication of the vehicle when its wheels are stuck in mud or deep snow

Do not deactivate the system except when absolutely necessary.

## B Cruise control buttons

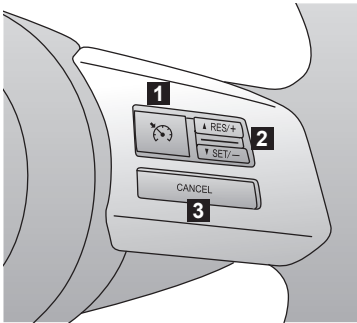

Cruise control enables you to maintain a constant vehicle speed without holding your foot on the accelerator pedal and it is operative when the vehicle speed is 40 km/h or more.

**1 Cruise control main button:** To activate and deactivate

**2 RES/SET switch**

- ▲RES/+ side: To increase the speed/To resume
- ▼SET/- side : To set speed/To decrease the speed

**3 CANCEL button:** To temporarily cancel

## C SI-DRIVE switches (if equipped)

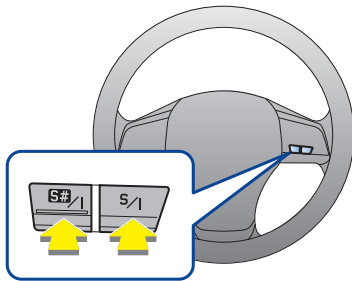

This system consists of two or three modes: Intelligent (I), Sport (S), and Sport Sharp (S#).

By operating the SI-DRIVE switches, the character of the power unit changes.

**Intelligent (I) mode:** Perform either of the following procedures.

- Press the **S/I** switch when the Sport (S) mode is selected.
- Press the **S#/I** switch when the Sport Sharp (S#) mode is selected.

**Sport (S) mode:**

Press the **S/I** switch when any mode other than Sport (S) mode is selected.

**Sport Sharp (S#) mode:**

Press the **S#/I** switch when any mode other than Sport Sharp (S#) mode is selected.

## D Multi function display

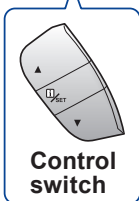
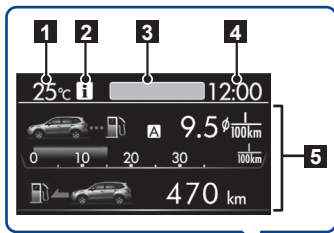

### 1 Outside temperature indicator

### 2 Information reminder:

The warning screen will return to the original screen after few seconds. Pull **i/SET** switch on the steering wheel toward you to recall the message.

### 3 Top display:

Displays the average fuel consumption, current fuel consumption or driving range on remaining fuel.

### 4 Clock

### 5 Driving information display:

By operating ▲ or ▼ of the control switch, the screens and selection items can be switched.

**Control switch:** By operating ▲ or ▼ of the control switch, the screens and selection items can be switched. When the **i/SET** switch is pulled toward you, the item can be selected and set.

## E X mode switch (if equipped)

X mode assists driving more comfortably even in slippery road conditions including uphill and downhill.

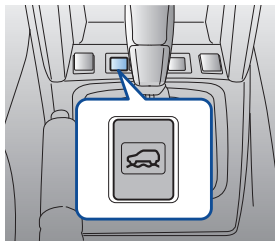

### To activate:

Press the X mode switch. While the X mode is activated, the X mode indicator light illuminates.

### To deactivate:

Press the X mode switch again. The X mode indicator light will turn off.



**Hill descent control indicator**

### Hill descent control function:

Using the hill descent control function, you can operate the vehicle keeping to a consistent speed downhill.

If the vehicle speed is likely to increase, the brake control system will be activated to adjust the vehicle speed.

## F Steering responsive fog lights OFF switch (if equipped)

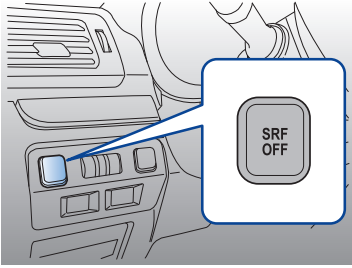

If the steering responsive fog lights OFF switch is pressed, the steering responsive fog lights OFF indicator is displayed on the Multi information display of the combination meter, and the steering responsive fog lights system is deactivated.

**SRF  
OFF**

**Steering responsive fog lights system  
OFF indicator**

### Steering responsive fog lights system

The steering responsive fog lights system automatically turns the front fog light on and off based on the steering angle and vehicle speed when entering a curve or driving on curved roads.

The system is intended to help prevent accidents by enabling better visibility of curves ahead and early recognition of any disabled vehicles or other obstacles.

# MAIN WARNING AND INDICATOR LIGHTS

Some warning/indicator lights illuminate for a few seconds in order to check themselves when the ignition switch is turned ON.

## Warning lights

Refer to your Owner's Manual for countermeasures when each warning light comes on. If necessary, consult your authorized SUBARU dealer.

### Seatbelt warning



Remind the driver to fasten seatbelt.

### Front passenger's seatbelt warning



Remind the front passenger to fasten seatbelt. Location: next to the information display.

### CHECK ENGINE warning/Malfunction indicator



Engine/Emission control system malfunction.

### Charge warning



Charging system malfunction.

### Oil pressure warning



The engine oil pressure is too low.

### Engine low oil level warning



The engine oil level decreases to the lower limit.

### All-Wheel Drive warning (CVT models)



Tires of different diameter fitted/air pressure excessively low.

### SRS airbag system warning



SRS airbag system and/or seatbelt pretensioners malfunction.

### Power steering warning



The electric power steering system malfunction.

### AT OIL TEMP warning (CVT models)



Transmission fluid temperature is too hot./Transmission control system malfunction.

### Automatic headlight beam leveler warning



Automatic headlight beam leveler malfunction.

### Brake system warning



Low fluid level/EBD system malfunction (ABS warning light illuminates simultaneously)

### Low fuel warning



Fuel tank is nearly empty. Refill fuel immediately.

### Windshield washer fluid warning



The fluid level in the windshield washer fluid tank decreases to the lower limit.



### Access key warning



The access key is not inside the vehicle. For other situations, refer to your Owner's Manual.

### Vacuum pump system warning (turbo engine models)



The vacuum pump system malfunction.

### ABS warning



Anti-lock Brake System malfunction/EBD system malfunction (Brake system warning light illuminates simultaneously).

### Vehicle Dynamics Control warning/Vehicle Dynamics Control operation indicator



**Warning** : Vehicle Dynamics Control system malfunction.

**Indicator** : Flashes during activation of the skid suppression function and the traction control function.

### Hill start assist warning/Hill start assist OFF indicator



**Warning** : Hill start assist system malfunction.

**Indicator** : Hill start assist system OFF.

### Steering responsive fog lights warning/ Steering responsive fog lights OFF indicator (models with EyeSight system)



**Warning** : The steering responsive fog lights system malfunction.

**Indicator** : The steering responsive fog lights system is deactivated.

### Coolant temperature low indicator/Coolant temperature high warning















**Illumination in BLUE** : Insufficient warming up of the engine.

**Illumination/blinking in RED** : Engine overheating/almost overheating.

**Blinking in RED and BLUE alternately**: Electrical system malfunction.

## Indicator lights

The following indicators show the current status of your car. Refer to your Owner's Manual for more information.

|   |   |  |
|---|---|--|
|  <b>Turn signal indicator</b>                             |  <b>Headlight indicator</b>            |  <b>High beam indicator</b> |
|  <b>Front fog light indicator</b>                         |  <b>Door open warning</b>              |  <b>Security indicator</b>  |
|  <b>Cruise control indicator</b>                          |  <b>Cruise control set indicator</b>   |  <b>X mode indicator</b>    |
|  <b>Vehicle Dynamics Control OFF indicator</b>            |  <b>Hill descent control indicator</b> |  |
|  <b>Front passenger's frontal airbag ON/OFF indicator</b> |  <b>SI-DRIVE indicator</b>             |  |



subaru.ca

All illustrations, specifications, features and photographs contained in this brochure are based on product information available at the time of its printing, and may not be completely accurate following its publication. Colours shown may vary due to reproduction variations in the printing process, and some vehicle parts cannot be shown in certain photographs. Subaru Canada, Inc. reserves the right to discontinue or make changes at any time, without notice or incurring obligations, to colours, materials, equipment, accessories, features, specifications and models, or to change their prices. Please visit our Web site for the latest information and specifications. For detailed operating and safety information, please consult your Owner's Manual. For complete details on product updates, warranties or the Subaru C.A.R.E. program, please contact your Subaru dealer. Forester and Subaru are registered trademarks. Printed in Canada. © 2015 Subaru Canada, Inc. 2016 model year.



**Environmental Management System (EMS)**  
**ISO 14001:2004 certified by SGS**  
[www.subaru-earth.com](http://www.subaru-earth.com)

SUBARU CANADA, INC. / FUJI HEAVY INDUSTRIES LTD.