

2015 Forester EyeSight



Owner's Manual



Foreword

Congratulations on choosing a SUBARU vehicle equipped with EyeSight™. EyeSight incorporates the latest driver assistance features available from SUBARU, including such features as Adaptive Cruise Control, a Lead Vehicle Start Alert and a Lane Departure and Lane Sway Warning, all of which are designed to assist the driver in making decisions and increase driver comfort and convenience. Initially, the operation and use of the various EyeSight features may be unfamiliar to you. That is why we urge you to read this manual carefully before using EyeSight. We also recommend that you first take the time to test EyeSight in order to experience its features for yourself so that you can become familiar with their operation.

Please keep in mind that it is the responsibility of drivers to operate their vehicles safely at all times. Drivers should always remain alert and should never become complacent while operating their vehicles because of the presence of EyeSight. EyeSight is never a substitute for active driver involvement and it may not operate optimally under all driving conditions.

This booklet is a supplement to the Owner's Manual for your SUBARU vehicle and contains a detailed description of EyeSight. It should be read in conjunction with your Owner's Manual so that you will gain a thorough understanding of the proper operation of your vehicle.

The information, specifications and illustrations found in this booklet are those in effect at the time of printing. FUJI HEAVY INDUSTRIES LTD. reserves the right to change specifications and designs at any time without prior notice and without incurring any obligation to make the same or similar changes on vehicles previously sold.

Please keep this booklet together with your Owner's Manual and leave it in the vehicle at the time of resale. The next owner will need the information it contains.

FUJI HEAVY INDUSTRIES LTD., TOKYO, JAPAN

 **SUBARU** is a registered trademark of FUJI HEAVY INDUSTRIES LTD.

© Copyright 2014 FUJI HEAVY INDUSTRIES LTD.

EyeSight

About EyeSight	2
Adaptive Cruise Control	21
Pre-Collision Braking System	43
Pre-Collision Throttle Management	52
Lane Departure Warning	58
Lane Sway Warning	61
Lead Vehicle Start Alert	64
Conventional Cruise Control	65
List of buzzer sounds	75
EyeSight malfunction and temporary stop	76
Customizing functions	79
List of the pop-up screens on the multi function display	81
Troubleshooting	84

About EyeSight

EyeSight

EyeSight is a driving support system that uses a range of functions to assist the driver in making decisions in order to provide for more safe and comfortable driving and to reduce driver fatigue. EyeSight makes use of original stereo cameras designed by SUBARU. Two CCD (Charge Coupled Device) cameras are used to process stereo images and identify the vehicle in front, obstacles, traffic lanes and other items.



WARNING

Drivers are responsible for driving safely. Strive for safe driving at all times. Always maintain a safe following distance behind the vehicle in front of you, pay attention to your surroundings and the driving conditions, operate the brake pedal and take other action as necessary in order to maintain a safe following distance.

Never attempt to drive relying on EyeSight alone.

EyeSight is intended to assist the driver in making decisions in order to reduce the chance of accidents or damage and lessen the burden on the driver.

When a warning is activated, pay attention to what is in front of you and to your surroundings, operate the brake pedal and take other action as necessary.

This system is not designed to support driving in poor visibility or in extreme weather conditions, or to protect against careless driving when the driver is not paying complete attention to the road ahead. It also cannot prevent collisions from occurring in all driving conditions.

There are limits to the EyeSight recognition performance and control performance. Be sure to read the instructions concerning Adaptive Cruise Control, the Pre-Collision Braking System, Pre-Collision Throttle Management and Conventional Cruise Control before using them and be sure to use them correctly. We are not liable for accidents or other problems resulting from failure to follow the instructions in this manual.

The EyeSight system in your vehicle is designed for use in countries in which traffic operates on the left-hand side of the road. EyeSight for RHD vehicles such as yours is not designed for use in countries in which vehicles are driven on the right-hand side of the road.

- The system may not operate correctly under the conditions listed below. When these conditions occur, turn off the Pre-Collision Braking System. Also, do not use Adaptive Cruise Control.
 - The tire pressure is not correct.*
 - The temporary spare tire is installed on any wheel.*
 - Tires that are worn or have large variations in wear conditions are installed.*
 - Tires other than those of the designated size are installed.*
 - An emergency repair is performed using the flat tire repair kit.
 - The suspension has been modified.
 - Tire chains are installed.
 - The headlights are dirty or the optical axes are not aligned correctly. (Objects are not correctly illuminated and are difficult to detect.)
 - Vehicle operation has become compromised due to an accident or malfunction.
 - The brake warning light is illuminated.
 - The vehicle is tilted due to a heavy cargo load.
 - The maximum number of occupants and/or the gross vehicle weight rating is exceeded.

*The wheels and tires have functions that are critically important. Be sure to use the correct ones. For details, refer to the Owner's Manual for your vehicle.

- The system may not operate correctly when towing a trailer or another vehicle. Do not use Adaptive Cruise Control in these situations.

CAUTION

- The characteristics of the stereo cameras are similar to those of human eyes. For this reason, conditions that make it difficult for the driver to see in the forward direction have the same effect on the stereo cameras and make it difficult for the system to detect vehicles, obstacles and traffic lanes.
- Detection by the EyeSight system is limited to objects that are within the range of the stereo cameras' field of vision. Also, after an object enters the range of the cameras' field of vision, it may take some time for the system to detect it as a controllable target and warn the driver.

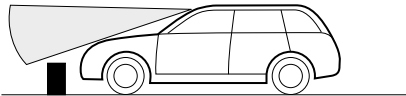
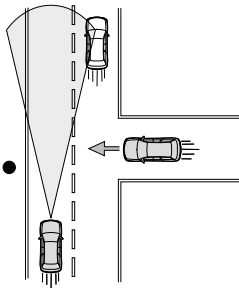

Low objects surrounding the vehicle cannot be detected.

S00713

- Under the conditions listed below, it will become more difficult for the system to detect the vehicle in front, motorcycles, bicycles, pedestrians and obstacles on the road and lane markers, and EyeSight may temporarily stop operating. However, the system will resume operation once these conditions have improved and the vehicle is driven for a short period of time.
 - Bad weather (for example heavy rain, a blizzard or thick fog). In particular, the system is more likely to temporarily stop operating when there is an oil film adhering to the windshield, a glass coating has been applied or old wipers are used.)
 - When affected by strong light from the front (sunlight or headlight beams, etc.)
 - The windshield has become fogged, or snow, dirt, dust or frost has adhered to it, reducing the stereo cameras' field of view.
 - The vehicle is tilted at an extreme angle due to loaded cargo or other factors.
 - When the stereo cameras' field of view is obstructed (for example by a canoe on the roof of the vehicle)
 - When visibility is poor due to sand, smoke or water vapor in the air, or when the vehicle in front or oncoming traffic causes water, snow, dirt or other substances to obscure the view

Continued on next page ⇒

⇒ Continued from previous page

- When passing through the entrance or exit of a tunnel
- When the rear aspect of the vehicle in front is low, small or irregular (for example a low bed trailer, etc.)
- When there is a fence, a wall or a shutter, etc. with a uniform pattern (a striped pattern, brick, etc.) or with no pattern in front
- When there is a wall or door made of glass or a mirror in front
- When water droplets or dirt have not been fully wiped off the windshield
- When driving at night or in a tunnel when there is a vehicle in front that does not have its taillights on
- When passing a banner or flag, low branches on a tree or thick/tall vegetation
- On steep uphill or downhill grades
- When the front of the cameras are obstructed by a hand, etc.
- When it is completely dark and no objects are detected
- When the area around the vehicle has a uniform color (such as when completely covered in snow, etc.)
- When the stereo camera lenses are dirty due to fingerprints, etc.
- When accurate detection is not possible due to reflections in the front windshield
- When the stereo cameras have become misaligned due to a strong impact
- Under the conditions listed below, EyeSight may temporarily stop operating. If this occurs, EyeSight will resume operating when the conditions improve.
 - The temperature inside the vehicle is high, such as after the vehicle was left in bright sunshine, or the temperature inside the vehicle is low, such as after the vehicle was left in an extremely cold environment.
 - Immediately after the engine starts
- When there is a malfunction in the EyeSight system, turn off the Pre-Collision Braking System (refer to page 51) and the Lane Departure Warning (refer to page 60), and stop using the Adaptive Cruise Control. Contact a SUBARU dealer and have the system inspected.

**NOTE**

- EyeSight records and stores the following data when the secondary braking of the Pre-Collision Braking System is operated. It does not record conversations or other audio data.
 - Stereo camera image data
 - Distance from the vehicle in front
 - Vehicle speed
 - Steering wheel turning angle
 - Lateral movement with regard to the direction of travel
 - Accelerator pedal operation status
 - Brake pedal operation status
 - Select lever position
 - Data related to ABS, Vehicle Dynamics Control and Traction Control Function

SUBARU and third parties contracted by SUBARU may acquire and use the recorded data for the purpose of vehicle research and development. SUBARU and third parties contracted by SUBARU will not disclose or provide the acquired data to any other third party except under the following conditions.

- The vehicle owner has given his/her consent.
- The disclosure/provision is based on a court order or other legally enforceable request.
- Data that has been modified so that the user and vehicle cannot be identified is provided to a research institution for statistical processing or similar purposes.

Handling of the Stereo Cameras

The stereo cameras are installed at the positions of the front map lights.

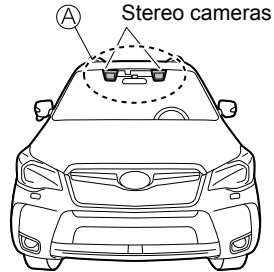

S00883

CAUTION

- A function is included that will automatically detect that the fronts of the stereo cameras are dirty. However it is not 100% effective. Under certain conditions, this function may fail to detect that the fronts of the stereo cameras have become dirty. In addition, this function may not detect that there is snow or ice on the windshield close to the stereo cameras. In such conditions, the system may not maintain a suitable distance between vehicles; therefore, do not use Adaptive Cruise Control and be sure to pay attention to what is ahead of you while driving. Also be sure to keep the windshield clean at all times (indicated by ). When this function detects that the fronts of the stereo cameras are dirty, no EyeSight functions are activated except for Conventional Cruise Control.
- The stereo camera lenses are precision components. Always observe the following precautions when handling them.
 - Never touch the stereo camera lenses, and do not attempt to wipe or clean the lenses. Doing so could cause lens damage or contamination and lead to improper system performance.
If you ever touch a lens for any reason, be sure to contact a SUBARU dealer.

- When cleaning the front windshield, cover the camera covers with plastic wrap, such as food wrapping, or something similar to prevent glass cleaner from getting on the camera lenses.
- If having your vehicle washed at a service station, etc., be sure to request that the attendant covers the camera covers before washing the vehicle.

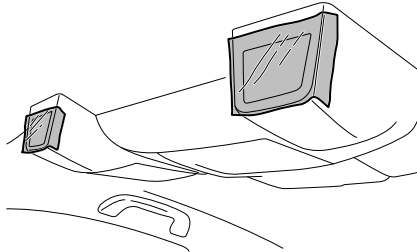

S00808

- Do not subject the stereo cameras to a strong impact.
- Do not remove or disassemble the stereo cameras.
- Do not change the positions where the stereo cameras are installed or modify any of the surrounding structures.
- Do not install an interior rearview mirror other than a genuine SUBARU rearview mirror (such as a wide-type mirror). Also, use the rearview mirror so that it does not obstruct the stereo cameras. Failure to do so may affect the stereo cameras' field of vision and could prevent the EyeSight system from functioning properly.

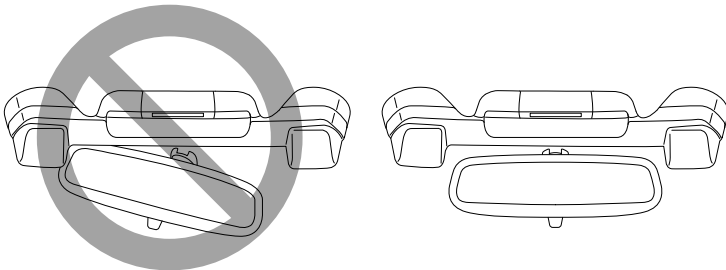

S00509

Continued on next page ⇒

⇒ Continued from previous page

- Do not affix any stickers or install any accessories on the prohibited areas shown in the illustrations below (grey zones). Doing so may affect the stereo camera's field of view and could prevent the EyeSight system from functioning properly. If you must affix any stickers, such as automobile inspection certificate stickers, or install accessories, do not cover the front of the cameras. If abnormal EyeSight operation occurs, remove the stickers or accessories.
- If the top of the instrument panel is polished with chemicals or other substances, the stereo cameras may not be able to detect objects accurately and the EyeSight system may not operate properly due to reflections in the front windshield.
- Side view
- Front view

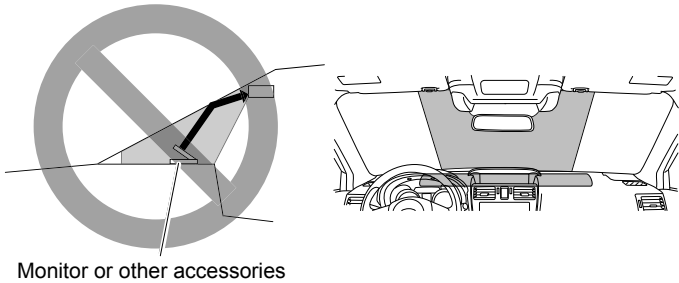

S00884

- Do not place any objects on top of the instrument panel and do not coat the surface above the instrument panel with chemical liquid. The stereo cameras may not be able to detect objects accurately and the EyeSight system may not function properly due to reflections in the front windshield. For details, contact a SUBARU dealer.
- Do not install any wiper blades other than genuine SUBARU wiper blades. Doing so may affect the stereo cameras' field of vision and could prevent the EyeSight system from functioning properly.
- Replace damaged wiper blades as soon as possible. The stereo cameras may not be able to detect objects accurately and the EyeSight system may not function properly due to liquid remaining on the windshield.
- Keep the windshield (outside and inside) clean at all times.
- Do not place any stickers or accessories on the windshield (outside or inside). If you have to do so (for example, legally required), avoid the area in front of the camera. Doing so may adversely affect the field of vision of the stereo camera and can cause improper operation of the system.
- Do not use any glass coating agents or similar substances on the windshield. Doing so may prevent the system from operating correctly.

- If there are scratches or cracks on the front windshield, contact a SUBARU dealer.
- To have the front windshield replaced or repaired, contact a SUBARU dealer. Do not install a front windshield other than a genuine SUBARU front windshield. The stereo cameras may not be able to detect objects accurately and the EyeSight system may not operate properly.

EyeSight Functions

EyeSight includes the following seven functions.

■ Adaptive Cruise Control

This function maintains the set vehicle speed and when there is a vehicle in front in the same traffic lane, it tracks the speed of the vehicle in front up to the maximum of the set vehicle speed.

* Refer to page 21.

■ Pre-Collision Braking System

This function uses a following distance warning feature to warn the driver to take evasive action when there is the possibility of a collision with a vehicle or obstacle in front of the driver's vehicle. If the driver still does not take evasive action, the brakes are quickly applied automatically just before the collision in order to reduce the collision damage or, if possible, prevent the collision.

* Refer to page 43.

■ Pre-Collision Throttle Management

This function reduces accidental forward movement caused by the selector lever being placed in the wrong position or the accelerator pedal being accidentally depressed, or depressed too strongly.

* Refer to page 52.

■ Lane Departure Warning

This function warns the driver when the vehicle is about to depart the traffic lane during driving.

* Refer to page 58.

■ Lane Sway Warning

This system detects vehicle drifting caused by driver fatigue, failure to concentrate on the road, inattention, strong crosswinds or other factors, and warns the driver.

* Refer to page 61.

■ Lead Vehicle Start Alert

This function notifies the driver when the vehicle in front has started moving but the driver's vehicle has not.

* Refer to page 64.

■ Conventional Cruise Control

In this mode, the system maintains a constant vehicle speed. Tracking of the vehicle in front does not occur. This function can be used even when the stereo cameras have temporarily stopped operating. (Refer to page 77.) (This function is used by switching from Adaptive Cruise Control to Conventional Cruise Control.)

* Refer to page 65.



NOTE

EyeSight does not operate when the engine is not running.

Instrument panel display layout

■ Combination meter

<Meter display (U.S. models)>

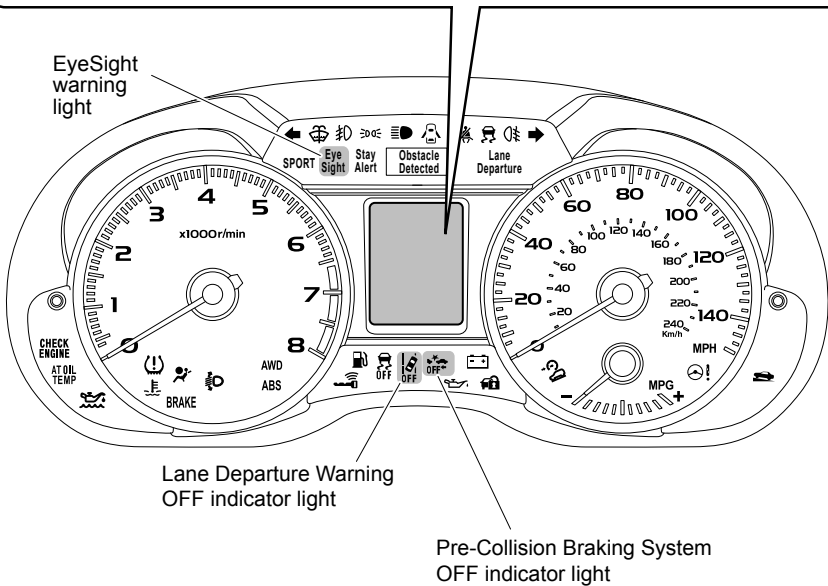
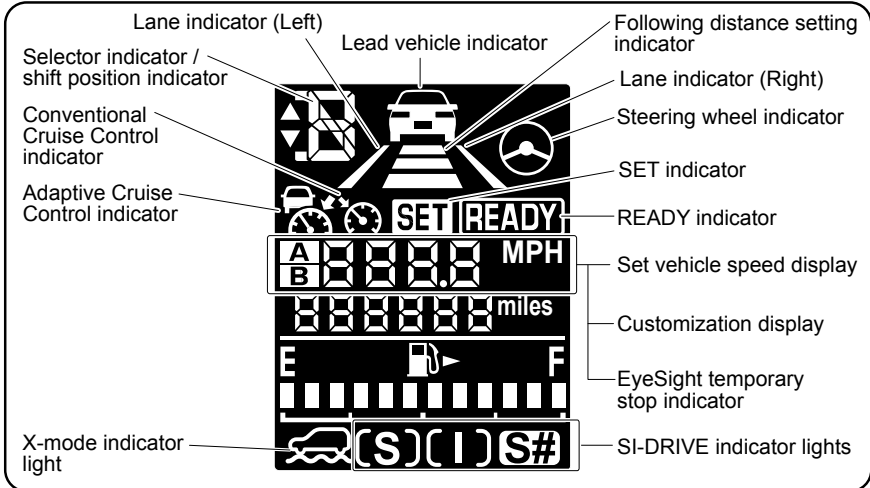

S01001

<Meter display (Canada models)>

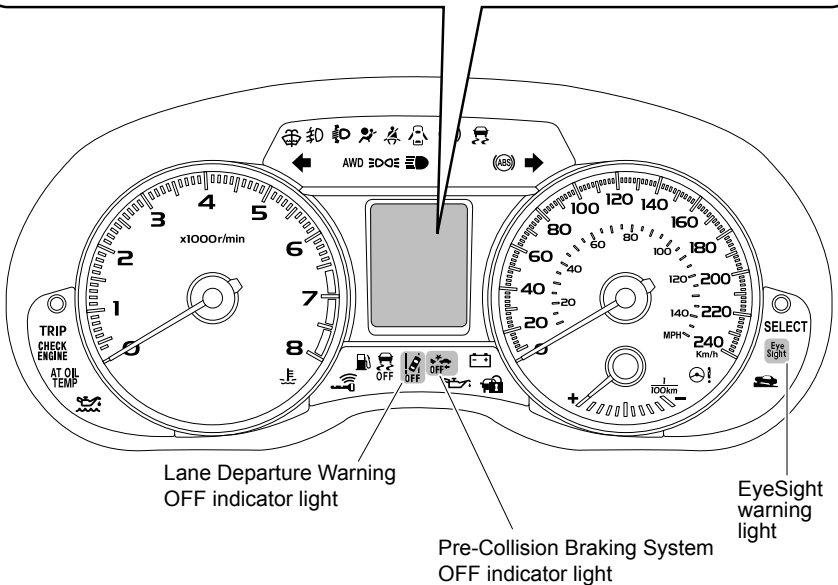
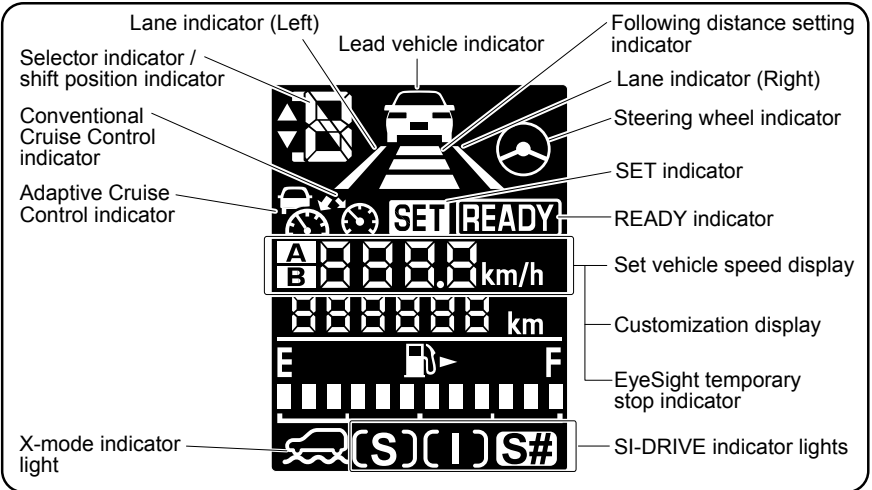

S01002

● CRUISE indicator

These indicators are displayed when the main cruise control  is pushed.



: Adaptive Cruise Control (Adaptive Cruise Control indicator)



: Conventional Cruise Control (Conventional Cruise Control indicator)

* Refer to page 28.

● SET indicator [Adaptive Cruise Control/Conventional Cruise Control]

SET is displayed when cruise control is set. When the vehicle stops, the indicator will blink until the cruise control is cancelled.

* Refer to page 29.

● READY indicator

READY is displayed when Adaptive Cruise Control can be set.

* Refer to page 28.

● Lead vehicle indicator

- When Adaptive Cruise Control is set, this indicator will be displayed when a vehicle in front has been detected.
- This indicator and the following distance setting indicator will blink in the following cases.
 - The Lead Vehicle Start Alert is active.
 - The Pre-Collision Braking System is active.
 - The “brake more” warning is active.
 - Pre-Collision Throttle Management is active.
- These indicators also flash if, after Adaptive Cruise Control is set, it is automatically canceled because a vehicle in front of your vehicle is now out of the detectable range of the EyeSight cameras.

* Refer to page 30.

● Following distance setting indicator

 (Following distance setting) Indicates the following distance setting that was set with the following distance setting switch.

This indicator blinks in the following cases.

- The “brake more” warning is active.
- The Pre-Collision Braking System is active.
- Pre-Collision Throttle Management is active.

* Refer to page 36.

● Set vehicle speed display

Displays the set vehicle speed.

* Refer to page 28.

● SI-DRIVE* mode indicator

Indicates the current SI-DRIVE mode.

*SI-DRIVE refers to SUBARU Intelligent Drive.

* Refer to page 19.

● **Selector indicator/shift position indicator**

- Displays the selector lever position or the selected gear position.
- For turbo models, when the Adaptive Cruise Control / Conventional Cruise Control is set while S# (Sports Sharp mode) of SI-DRIVE is selected, the display switches from the gear position to the D position.

● **Lane indicator**

- When the Lane Departure Warning is activated, both the left and right indicators flash simultaneously.
- When the Lane Sway Warning is activated, the left and right indicators flash alternately.

* Refer to pages 58 and 61.

● **Steering wheel indicator**

Flashes when the Lane Departure Warning or Lane Sway Warning is active.

* Refer to pages 58 and 61.

● **EyeSight temporary stop indicator**

- If a malfunction occurs in the EyeSight system, the Pre-Collision Braking System OFF indicator light and the Lane Departure Warning OFF indicator light illuminate and a symbol from “E1” to “E3” will be displayed on the meter display. However, when the main cruise control is in the OFF position, the symbol will not be displayed.
- When it is displayed, none of the EyeSight functions can be used except for Conventional Cruise Control.

* Refer to page 77.

● **Customization display**

The settings of the alarm volume, the lead vehicle acquisition sound and the lead vehicle start alert function can be customized when all of the following conditions are met: the engine is running, the main cruise control is in the OFF position and the selector lever is in the P position.

* Refer to page 79.

● **EyeSight warning light**

- This indicator illuminates or flashes when a malfunction occurs in the EyeSight system.
- It also illuminates when the ignition switch is turned to the ON position and then it turns off approximately 5 seconds after the engine starts.
- When it is illuminated or flashing, none of the EyeSight functions can be used (including Adaptive Cruise Control and the Pre-Collision Braking System, etc.).

* Refer to page 76.

● Lane Departure Warning OFF indicator light

- This indicator illuminates when the Lane Departure Warning and Lane Sway Warning are off.
- It also illuminates when the ignition switch is turned to the ON position, and then approximately 7 seconds after the engine starts, it turns on or off depending on the current status (ON or OFF).

* Refer to page 60.

● Pre-Collision Braking System OFF indicator light

- Illuminates when the Pre-Collision Braking System and Pre-Collision Throttle Management are off.
- It also illuminates when the ignition switch is turned to the ON position, and then turns off approximately 7 seconds after the engine starts.

* Refer to pages 51 and 57.

■ Multi function display

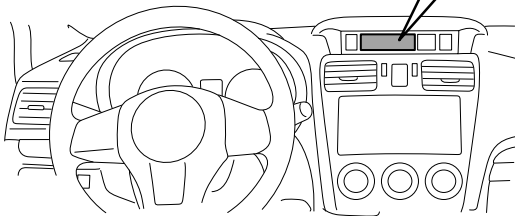
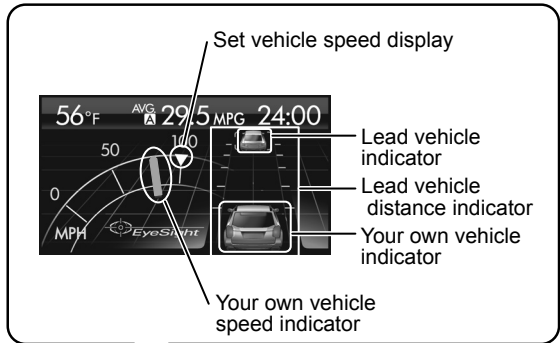

S00885

● Your own vehicle speed indicator

Indicates your own vehicle speed with a red indicator.

● Set vehicle speed indicator

Indicates the set vehicle speed.

* Refer to page 29.

● Your own vehicle indicator

When the brake pedal is depressed or the brake control function is active, the brake light on the indicator illuminates in red.

● Lead vehicle indicator

While the Adaptive Cruise Control is set to on, this indicator is displayed when a vehicle is detected in front.

* Refer to page 30.

● Lead vehicle distance indicator

While the Adaptive Cruise Control is set to on, the distance to the vehicle in front is visually displayed when following the vehicle in front.



NOTE

For Canada models, if an EyeSight warning or malfunction is detected, a corresponding message will be displayed on the multi function display. However for USA models, only a malfunction message will be displayed.

* Refer to page 81.

Switch layout

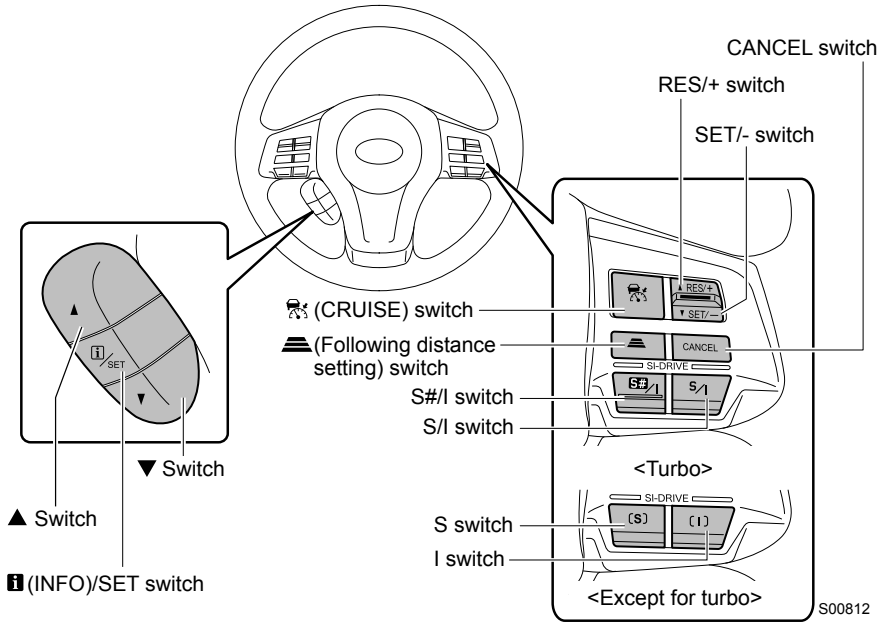

Steering wheel switches



● (CRUISE) switch

- Switches cruise control* on/off.

* Refer to page 28.

- When this switch is pressed and “” or “” appears on the instrument panel, the main cruise control is on.

* Adaptive Cruise Control and Conventional Cruise Control

● SET/- switch

- Can be used to set cruise control*.
- Can be used to reduce the set vehicle speed (when cruise control* is currently set).

* Adaptive Cruise Control and Conventional Cruise Control

● RES/+ switch

- After cruise control* is canceled, this switch can be used to resume the cruise control function at the vehicle speed that was previously set.
- Can be used to increase set vehicle speed (when cruise control* is currently set).

* Adaptive Cruise Control and Conventional Cruise Control

● **CANCEL switch**

Cancels cruise control*.

* Adaptive Cruise Control and Conventional Cruise Control

* Refer to pages 37 and 71.

●  (Following distance setting) switch

- Can be used to switch the set following distance in 3 stages: Far, Medium and Close (only when Adaptive Cruise Control is set).

* Refer to page 36.

- When the  (CRUISE) switch is on, press and hold this switch for approximately 2 seconds or longer to select Adaptive Cruise Control or Conventional Cruise Control.

● **SI-DRIVE*** switch

Selects the tracking characteristics linked with the SI-DRIVE (only when adaptive cruise control is set).

* SI-DRIVE refers to SUBARU Intelligent Drive.

▼ **Turbo model**

- **S/I switch**

- Switches between I (Intelligent mode) and S (Sports mode) every time it's pressed.
- While S# (Sports Sharp mode) is selected, press the switch to change to S (Sports mode).

- **S#/I switch**

- Press the switch to change to S# (Sports Sharp mode).
- While S# (Sports Sharp mode) is selected, press the switch will change to I (Intelligent mode).

▼ **Except for turbo model**

- **S switch**

- Press this switch to change to S (Sports mode).

- **I switch**

- Press this switch to change to I (Intelligent mode).

● **SI-DRIVE cooperative control**

The characteristics of adaptive cruise control will vary depending on the SI-DRIVE mode selection.

I (Intelligent mode) selected	Tracks the vehicle in front speed with smooth motions.
S (Sports mode) selected	Vehicle in front tracking performance is given priority, resulting in tracking with frequent changes in speed.
S# (Sports Sharp mode) selected 	The same vehicle in front tracking as S (Sports mode) is performed. The S# (Sports Sharp) response is provided when the driver operates the accelerator pedal.

● ▲ switch/ ▼ switch

The screen displayed on the multi function display can be switched.

● ⓘ (Info)/SET switch

The pop up screen displayed on the multi function display can be displayed again.

* Refer to page 81.

■ Pre-Collision Braking System OFF switch

Press and hold this switch for approximately 2 seconds or longer to turn off the Pre-Collision Braking System and Pre-Collision Throttle Management.

When these functions are off, the Pre-Collision Braking System OFF indicator light on the instrument panel illuminates.

Press and hold the switch again to turn on the Pre-Collision Braking System and Pre-Collision Throttle Management. This turns off the Pre-Collision Braking System OFF indicator light.

* Refer to page 51.

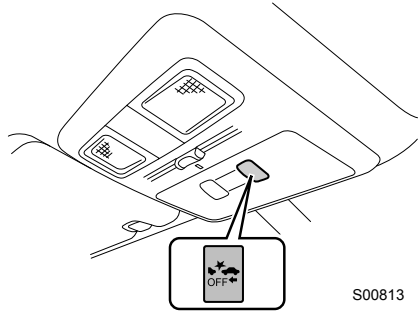

■ Lane Departure Warning OFF switch

Press and hold this switch for approximately 2 seconds or longer to turn off the Lane Departure Warning and Lane Sway Warning functions.

When these functions are off, the Lane Departure Warning OFF indicator light on the instrument panel illuminates.

Press and hold the switch again to turn on the Lane Departure Warning and Lane Sway Warning functions. This turns off the Lane Departure Warning OFF indicator light.

* Refer to page 60.

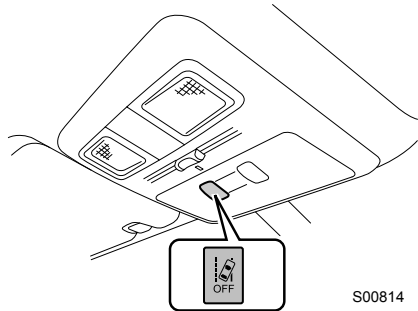

Adaptive Cruise Control

Adaptive Cruise Control is a driving support system intended to allow more comfortable driving on expressways, freeways and interstate highways. The vehicle in front in the same traffic lane is detected by means of the stereo cameras, and your vehicle tracks the vehicle in front (up to the maximum speed of the set vehicle speed) while automatically maintaining a following distance that corresponds to the speed of the vehicle in front. Please remember that you should not exceed posted speed limits. The vehicle is not equipped with a function that helps maintain the vehicle's standstill position without a driver's operation.



WARNING

- This system does not provide the driver with an automatic driving function that handles all traffic conditions.
- Do not rely excessively on Adaptive Cruise Control. This system is not intended to assist in driving when the driver is not paying full attention to what is ahead of him/her due to distractions or a lack of concentration while driving, or under conditions of poor visibility. It is not intended to prevent rear-end collisions.
Strive for safe driving at all times. Always maintain a safe following distance behind the vehicle in front of you, pay attention to your surroundings and the driving conditions, and operate the brake pedal and take other action as necessary.
- Set the set vehicle speed within a range that is appropriate to the road conditions and surrounding environment.
- The system may not operate correctly under the conditions listed below. When these conditions occur, do not use Adaptive Cruise Control.
 - The tire pressure is not correct.*
 - The temporary spare tire is installed on any wheel.*
 - Tires that are worn or have large variations in wear conditions are installed.*
 - Tires other than those of the designated size are installed.*
 - An emergency repair is performed using the flat tire repair kit.
 - The suspension has been modified.
 - Tire chains are installed.
 - The headlights are dirty or the optical axes are not aligned correctly. (Objects are not correctly illuminated and are difficult to detect.)
 - Vehicle operation has become compromised due to an accident or malfunction.
 - The brake warning light is illuminated.
 - The vehicle is tilted due to a heavy cargo load.
 - The maximum number of occupants and/or the gross vehicle weight rating has been exceeded.
 - When towing a trailer or another vehicle, etc.
- Adaptive Cruise Control is designed for use on expressways, freeways, toll roads, interstate highways and similar limited access roads. It is not intended to be used in city traffic. In the following conditions, do not use Adaptive Cruise Control. Doing so may result in an accident.
 - Ordinary roads (roads other than those mentioned above)
Depending on the driving environment (complexity of roads and other factors), the system may not be able to perform as the traffic conditions require, and that may result in an accident.
 - Roads with sharp curves or winding roads
 - Frozen roads, snow-covered roads or other slippery road surfaces
The tires may spin, causing loss of control of the vehicle.

Continued on next page ⇒

⇒ Continued from previous page

- Traffic conditions when frequent acceleration and deceleration make it difficult to maintain the following distance
It may not be possible for the system to perform as the traffic conditions require.
- Steep downhill grades
The set vehicle speed may be exceeded.
- On a steep continuous downhill grade
The brakes may overheat.
- Roads and overpasses with repeated steep uphill and downhill grades
Detection of the vehicle in front may be lost, or the road surface may be detected instead of the vehicle in front, making correct control impossible.
- When entering an interchange, service area, parking area, junction, toll booth or other facility
Detection of the vehicle in front may not be possible.
- When there are sudden changes in brightness, such as at a tunnel entrance or exit
- When visibility is poor due to sand, smoke or water vapor blowing in the wind, or when the vehicle in front or oncoming traffic causes water, snow, dirt or dust to obscure the view
Detection of the vehicle in front may be lost, or water or other substances may be incorrectly detected instead of the vehicle, making correct control impossible.

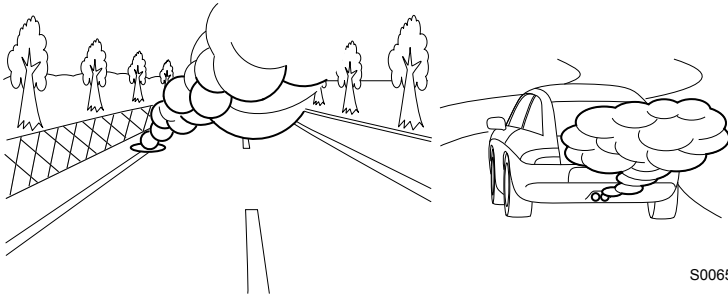

S00652

- When there is snow, frost, dirt or dust on the windshield or it is clouded
- When water droplets from rain or the window washer, or dirt has not been fully wiped off the windshield
It may not be possible to detect the vehicle in front, making correct control impossible.
- When the stereo cameras' field of view is obstructed (for example by a canoe on the roof of the vehicle)

- The stereo cameras may have difficulty detecting the following objects or conditions. Operate the brake pedal and take other actions as necessary.
 - Vehicles at significantly different speeds (vehicles driving slowly, stopped or oncoming vehicles, etc.)
 - Vehicles cutting into your lane
 - Motorcycles, bicycles, pedestrians and animals, etc.
 - When light is poor in the evening or early morning
 - When driving at night or in a tunnel without the headlights on
 - When driving at night or in a tunnel when there is a vehicle in front that does not have its taillights on
 - When affected by strong light from the front (sunlight or headlight high beams, etc.)
 - Vehicles in front that have a rear aspect that is low, small or irregular (the system may recognize another part of the vehicle and will determine operation from that)
 - An empty truck or trailer that has no cargo in the cargo bed being affected by wind
 - Vehicles that have cargo protruding from their back ends
 - Non-standard shaped vehicles (vehicle transporters or vehicles with a sidecar fitted, etc.)
 - Vehicles that are low
 - Objects that are located close to the bumper of your vehicle
- When you do not want to use Adaptive Cruise Control, be sure to turn the  (CRUISE) switch off. If the switch is left on, cruise control may be accidentally engaged, possibly resulting in an accident.
- Before using Adaptive Cruise Control, be sure to fully verify the safety of the vehicle occupants and the area around the vehicle. Never operate the cruise control from outside the vehicle.

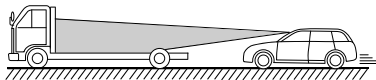

S00654

Continued on next page ⇒

⇒ Continued from previous page

Detection of the vehicle in front by the EyeSight stereo cameras

- Under the following road conditions or conditions of your vehicle, detection of the vehicle in front may not be possible. Vehicles in neighboring traffic lanes or roadside objects may also be incorrectly detected. Under conditions such as these, do not use Adaptive Cruise Control. If cruise control is currently in use, operate the brake pedal and take other action as necessary.

- When tracking begins from a short following distance, such as when the vehicle in front is a vehicle that cut into your lane

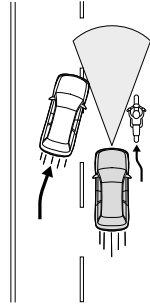

S00639

- When driving on curved roads, at the start and end of a curve and on roads with continuous curves (These conditions make it difficult for the system to detect vehicles because they are outside the detectable area.)

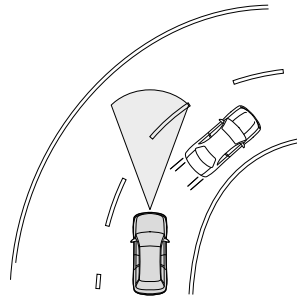

S00640

- When driving on an on-ramp or off-ramp to a freeway, highway, or other restricted access road (EyeSight Adaptive Cruise Control is not designed for use in this kind of driving environment.)
- When driving in an urban, or suburban environment (Adaptive Cruise Control is not appropriate for use in these driving areas. Adaptive Cruise Control should only be used on limited-access highways.)

- When the vehicle in front is not directly ahead of your vehicle and is shifted to one side

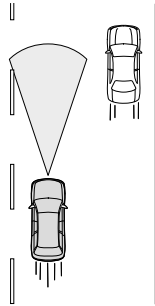

S00641

- When there is an obstacle at the side of the road

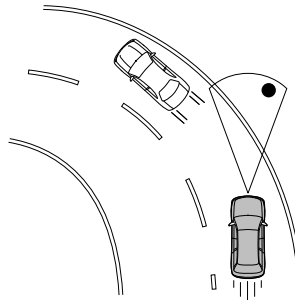

S00642

- When the speed difference with the vehicle (or object) in front is more than 20 MPH (30 km/h)
- When a vehicle cuts into your lane in front of you
- When the distance between vehicles is extremely small
- When your vehicle is drifting within the lane
- When driving on a bumpy or unpaved road surface
- When driving on a road with extremely narrow lanes, such as when traffic restrictions are in effect or in areas where construction work is taking place
- When normal driving has become compromised due to an accident or malfunction
- When extremely heavy cargo is loaded in the cargo area, rear seat or trunk of your vehicle
- There are limits to the capabilities of Adaptive Cruise Control. Even when the vehicle in front is detected, the system may not be able to decelerate in time in cases such as when the difference in speeds is large or when the vehicle in front decelerates suddenly. Operate the brake pedal and decelerate as necessary.
- Before using the system, perform a daily inspection and verify that there are no malfunctions of the tires or brakes.
*Refer to the separate "Warranty and Maintenance Booklet".
- If the buzzer sounds frequently, do not use Adaptive Cruise Control.

Continued on next page ⇒

⇒ Continued from previous page

- Even when the following distance is short, the “brake more” warning may not activate in the following cases.
 - When the speed difference compared to the vehicle in front is small (the two vehicles are travelling at almost the same speed)
 - When the vehicle in front is traveling faster than your vehicle (the following distance is gradually increasing)
 - When another vehicle cuts into your lane very close to your vehicle
 - When the vehicle in front decelerated suddenly
 - When there are repeated uphill and downhill grades

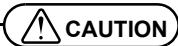

- After Adaptive Cruise Control has started, it maintains control continuously according to the behavior of the vehicle in front. When your vehicle comes to a stop because the vehicle in front has stopped, the automatic braking function will be cancelled immediately after stopping and the vehicle will start creeping forward gradually (at the same time three short beeps and a single long beep will sound). Be sure to depress the brake pedal and stop the vehicle completely.

Note that the vehicle is not maintained at a standstill position and will not automatically start moving from a standstill position.
- Braking may not be sufficient depending on the following conditions. Operate the brake pedal and decelerate as necessary.
 - Vehicle conditions (amount of load, number of occupants, etc.)
 - Road conditions (grade, slipperiness, shape, bumps, etc.)
 - Vehicle maintenance status (brake systems, tire wear, air pressure, temporary spare tire is being used, etc.)
 - When the brakes are cold. (For example, just after the engine is started or when the outside temperature is low.)
 - For a short period of time when driving after the engine is started until the engine has warmed-up
 - When the brakes are overheated on downhill grades (braking effectiveness may be reduced)
 - When driving in rain or after washing the vehicle (the brakes may become wet and braking effectiveness may be reduced)
 - When the speed to potential obstacles is more than 20 MPH (30 km/h)

Functions of Adaptive Cruise Control

When there is no vehicle in front in the same lane, the vehicle drives constantly at the set vehicle speed. When there is a vehicle in front in the same lane, the vehicle tracks the vehicle in front up to the maximum set vehicle speed. When the vehicle stops because the vehicle in front has stopped, the automatic braking function will be cancelled immediately after stopping and the vehicle will start creeping forward gradually. The vehicle is capable of being controlled at a speed between approximately 0 and 90 MPH (145 km/h). Please remember that you should not exceed posted speed limits.

■ “Brake more” warning

When the system determines that braking applied by Adaptive Cruise Control will be insufficient, a buzzer will sound and an indicator in the meter display will illuminate to warn the driver.

Also, a pop-up screen will be displayed in the multi function display.

* Refer to page 42.





CAUTION

If the driver operates the brake pedal during automatic braking, the pedal may feel stiff; however, this is not a malfunction. By depressing the brake pedal further you can apply more braking force. When the brake pedal is released it will return to its original condition.



NOTE



- Vehicles in front in the same traffic lane are detected by the stereo cameras within a distance of approximately 265 ft (80 m) in the forward direction. However the detection distance may be reduced depending on the traffic environment, driving conditions, and conditions of the vehicle in front.
- Changing the SI-DRIVE mode allows adaptive cruise control to track the vehicle in front utilizing the characteristics of each mode.
- When driving on a curve, the vehicle may not accelerate, or may decelerate, even if the set speed is higher than the current vehicle speed.
- If the  (Adaptive Cruise Control) is not displayed when the  (CRUISE) switch is pressed, there may be a malfunction in the system. Contact a SUBARU dealer and have the system inspected.
- Some noises may be audible during automatic braking. This is caused by the braking control and does not indicate a malfunction.

How to use Adaptive Cruise Control

The Adaptive Cruise Control can be used while the engine is running.

■ Setting the Adaptive Cruise Control

(1) Setting Adaptive Cruise Control to standby status

Press the  (CRUISE) switch. The Adaptive Cruise Control will be turned on and  (Adaptive Cruise Control) and  (following distance setting) will be displayed on the EyeSight indicator section located in the meter.

The trip meter switches to the set vehicle speed display and “- - - MPH (USA) or km/h (Canada)” will be displayed.

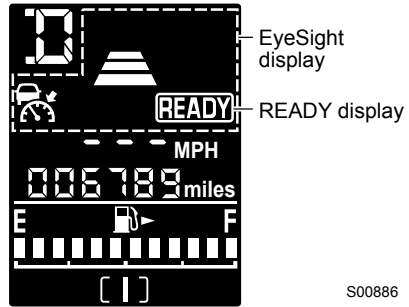
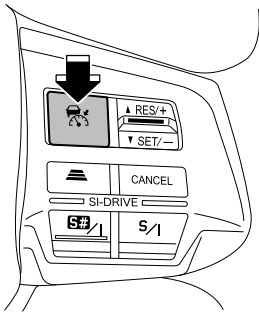

If the switch is pressed once more, the EyeSight display will turn off. It will also automatically turn off when the engine is stopped.

When all of the following conditions are met, the Adaptive Cruise Control can be set and the “READY” indicator will be displayed on the EyeSight indicator section.

- All doors including the driver’s door, passenger’s door and rear doors are closed.
- The driver’s seatbelt is fastened.
- The parking brake is released (the brake warning light goes off).
- The select lever is in the “D” position, and “D” is displayed on the combination meter.
- The brake pedal is not depressed.
- EyeSight operation is not temporarily stopped.



* Refer to page 71.

- The road is not a steep slope.
- The steering wheel has not been turned significantly in either direction.
- Vehicle Dynamics Control was not turned off (the VDC OFF indicator light goes off).
- The X mode is not turned on (the X mode indicator light  goes off).
- The vehicle speed is over approximately 25 MPH (40 km/h).
- The vehicle speed is approximately 25 MPH (40 km/h) or less and there is a vehicle in front.



NOTE

When the main cruise control is turned on by pressing the  (CRUISE) switch, the multi function display switches to the EyeSight screen.

To return to the triple meter clock display, pull the   switch on the steering wheel toward you.

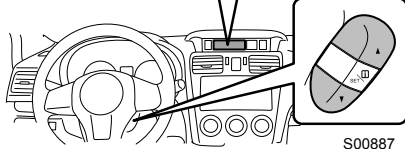
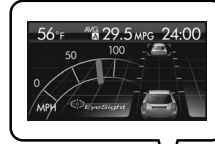

S00887

(2) Press the SET/- switch to set the Adaptive Cruise Control. The Adaptive Cruise Control starts to control the vehicle speed.

The set vehicle speed and the SET indicator is displayed on the meter display. Also, The set vehicle speed indicator ( mark) will be displayed.

If no vehicle in front has been detected, the vehicle drives at the constant speed.

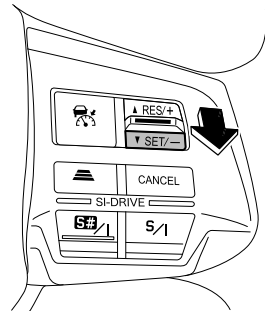

S00818

<Meter display>

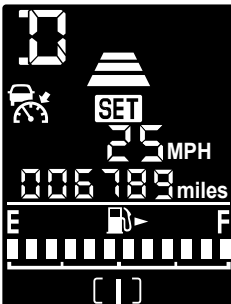

S00888

<Multi function display>



S00889

 **NOTE**

- The set vehicle speed can be adjusted within the range from 25 MPH (40 km/h) to 90 MPH (145 km/h).
- If cruise control is set while driving the vehicle at approximately 25 MPH (40 km/h) or less, the set vehicle speed is automatically set to 25 MPH (40 km/h).
- For turbo models, if the Adaptive Cruise Control is set while the S# (Sports Sharp mode) of SI-DRIVE is selected, the shift position indicator will change from the gear position to the  position.

When a vehicle in front is detected, a buzzer sounds 1 short beep and the lead vehicle indicator will be displayed.

The vehicle tracks the lead vehicle in front and maintains the selected following distance. At this time, the speed upper limit is the set vehicle speed. If the vehicle in front is no longer detected, a buzzer sounds 1 short beep and the lead vehicle indicator turns off.

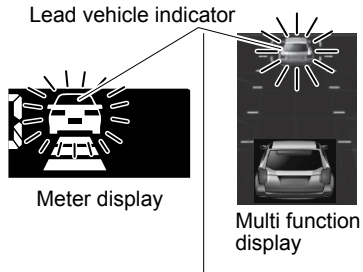

S00821

 **NOTE**

The buzzer sound (lead vehicle acquisition sound) that occurs when a vehicle in front is detected or no longer detected while Adaptive Cruise Control is set can be turned off by customization.

* Refer to page 79.

Operation of Adaptive Cruise Control

- When no vehicle in front is detected

The vehicle drives constantly at the set target vehicle speed between approximately 25 MPH (40 km/h) and 90 MPH (145 km/h).

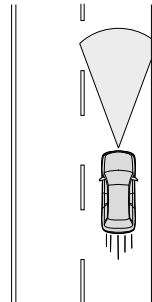

S00643

- When a vehicle in front is detected

The vehicle tracks the lead vehicle in front, and will maintain the chosen following distance, up to the set target vehicle speed - between 25 MPH (40 km/h) and 90 MPH (145 km/h).

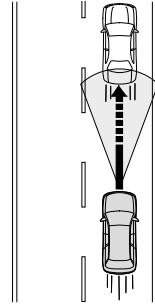

S00644

- If the lead vehicle is no longer tracked within a distance of approximately 100 ft (30 m) and a speed of approximately 20 MPH (30 km/h) or less is detected, a buzzer sounds single long beep and Adaptive Cruise Control function is canceled.

At this time, the lead vehicle indicator flashes.

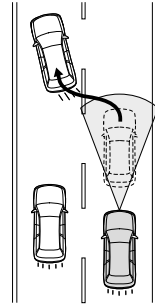

S00645

If the vehicle in front is no longer detected under conditions other than the previous ones, the vehicle gradually accelerates back to the set target vehicle speed and will drive at that constant speed.

If a vehicle in front is detected while accelerating to the set target vehicle speed, vehicle tracking will be started again.

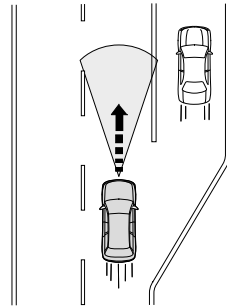

S00646

**NOTE**

- When the brakes are applied by Adaptive Cruise Control, the vehicle's brake lights will illuminate.
- Even if there is no lead vehicle present, on a downhill grade, the Adaptive Cruise Control's automatic brake may operate in order to maintain the set target vehicle speed.
- To temporarily accelerate quickly, use the accelerator pedal.

■ Increasing the set vehicle target speed

● Using the RES/+ switch

While driving with Adaptive Cruise Control on, operate the RES/+ switch as follows.

- Push the RES/+ switch briefly.
Every time the switch is pushed, the set vehicle target speed will increase in increments of 5 MPH (5 km/h).
- Push the RES/+ switch continuously.
While the switch is being pushed, the set vehicle target speed will increase in increments of 1 MPH (1 km/h).

When operating the switch, the set vehicle target speed changes on the meter display and the multi function display.

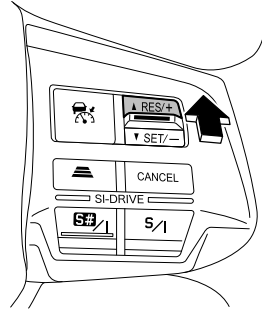

<Meter display>

<Multi function display>

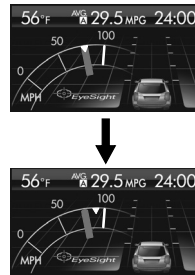
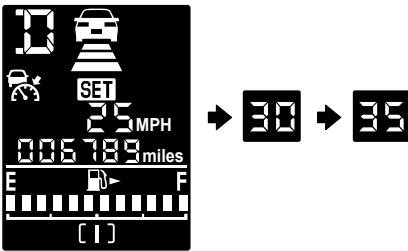

● Using the accelerator pedal

Depress the accelerator pedal to increase the vehicle speed. Once the preferred speed has been attained, push the SET/- switch. The set vehicle target speed is set to the vehicle speed that is attained when the switch is pushed. The set vehicle target speed is displayed on the meter display and the multi function display.

■ Decreasing the set vehicle target speed

● Using the SET/- switch

While driving with Adaptive Cruise Control on, operate the SET/- switch as follows.

- Push the SET/- switch briefly.

Every time the switch is pushed, the set vehicle target speed will decrease in increments of 5 MPH (5 km/h).

- Push the SET/- switch continuously.

While the switch is being pushed, the set vehicle target speed will decrease in increments of 1 MPH (1 km/h).

When operating the switch, the set vehicle target speed changes on the meter display and the multi function display.

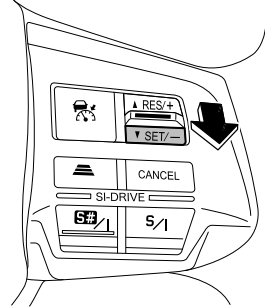

S00818

<Meter display>

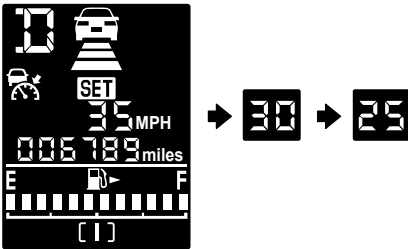

S00892

<Multi function display>

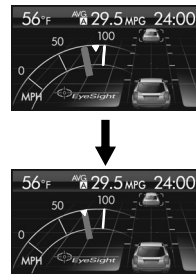

S00893

● Using the brake pedal

Depress the brake pedal to decrease the vehicle speed (the Adaptive Cruise Control is cancelled). Once the preferred speed has been attained, push the SET/- switch. The set vehicle target speed is set to the vehicle speed that is attained when the switch is pushed, and the set vehicle target speed is displayed on the meter display and the multi function display.

■ Accelerating the vehicle temporarily

Depress the accelerator pedal to accelerate the vehicle temporarily.
When the accelerator is released, the vehicle returns to the set vehicle target speed.



NOTE

For turbo models, if the S# (Sports Sharp mode) of SI-DRIVE is selected, the shift position indicator will change from the gear position to the  position when the accelerator pedal is depressed.

■ Decelerating the vehicle temporarily

Depress the brake pedal to decelerate the vehicle temporarily. At this time, the Adaptive Cruise Control is cancelled.

The display screen will change as follows.

- Meter display:
The SET indicator disappears with the set vehicle target speed shown.
- Multi function display:
The set vehicle speed indicator ( mark) disappears.

To set the set vehicle target speed again, push the RES/+ switch.

<Meter display>

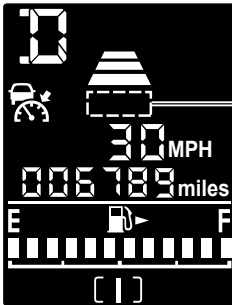

SET indicator turns off.

S00894

<Multi function display>



▼Mark turns off.

S00895

**CAUTION**

- When Adaptive Cruise Control is operating, actual vehicle speed is controlled according to the lead vehicle. Therefore, if the RES/+ switch is pressed and set to a speed higher than the speed of the lead vehicle, the vehicle will not accelerate - it will maintain a safe following distance as first priority.
However because doing so changed the set vehicle target speed, when the lead vehicle is no longer detected (for example if you change to a free-way lane with no vehicles in front), the vehicle will accelerate to that new set target speed. Change the set vehicle target speed while briefly checking the value shown in the set speed display on the meter display.
- When the accelerator pedal is depressed with Adaptive Cruise Control on, automatic braking control and warnings by Adaptive Cruise Control will not occur. However, if there is a high risk of collision with an obstacle in front of the vehicle at this time, the warning and braking control of the Pre-Collision Braking System may activate.
- Ordinarily, while Adaptive Cruise Control is functioning, acceleration and deceleration are performed automatically according to the speed of the lead vehicle (if one is detected). However, when your vehicle approaches a lead vehicle, for example if it is necessary to accelerate for a lane change or other reason, and if the vehicle in front suddenly decelerates, or if another vehicle cuts into your path, operate the accelerator pedal or brake pedal and accelerate or decelerate as appropriate for the existing conditions.

■ Changing the following distance:



The following distance from the vehicle in front can be set to three levels.

Each time the  (following distance setting) switch is pressed, the following distance from the vehicle in front switches in the following sequence:

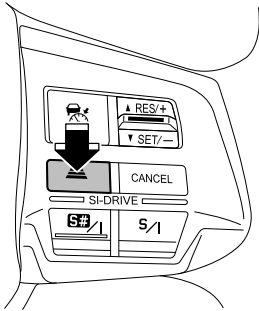
Far → Medium → Close → Far





S00829

Following distance setting	Display
Far	
Medium	
Close	

S00830



NOTE

- Every time the  (CRUISE) switch is turned off or the engine is started, the following distance setting will be set to "Far". When the following distance setting is changed again, press the  (following distance setting) switch.
- The following distance changes according to the vehicle speed and is further the faster that the vehicle is traveling at.

<Approximate guide to following distances>

Following distance	Your vehicle speed	
	Approx. 25 MPH (40 km/h)	Approx. 60 MPH (100 km/h)
Far	Approx. 85 ft (25 m)	Approx. 175 ft (50 m)
Medium	Approx. 65 ft (20 m)	Approx. 135 ft (40 m)
Close	Approx. 50 ft (15 m)	Approx. 95 ft (30 m)

■ Canceling Adaptive Cruise Control

● Canceling by driver operation

Either of the following operations will cancel Adaptive Cruise Control.

- Press the CANCEL switch
- Depress the brake pedal.

The display screen will change as follows.

- Meter display:
The SET indicator disappears with the set vehicle target speed shown.
- Multi function display:
The set vehicle speed indicator (▼ mark) disappears.

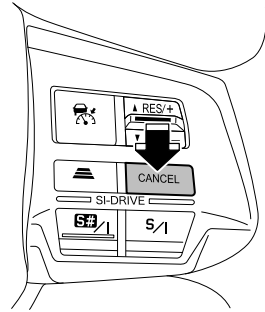

S00831

<Meter display>

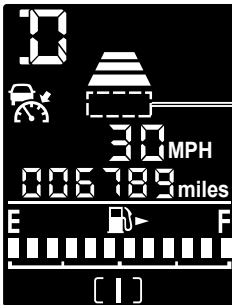

SET indicator turns off.

S00894

<Multi function display>



▼Mark turns off.

S00895

- Press the  (CRUISE) switch.
The EyeSight display disappears and the Adaptive Cruise Control is turned to OFF.

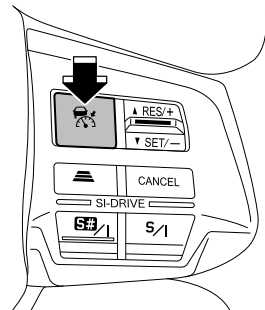

S00815



NOTE

When the Adaptive Cruise Control is turned OFF, the screen of the multi function display will switch to the triple meter screen.

* For details, refer to the Owner's Manual for your vehicle.



S00896

Automatic cancellation by the system

When the vehicle stops in accordance with the stopping of the vehicle in front, three short beeps and a single long beep will sound and the Adaptive Cruise Control is automatically cancelled.



CAUTION

The automatic braking function is released gradually approximately 2 seconds after stopping and the vehicle starts creeping forward. Be sure to depress the brake pedal and stop the vehicle completely.



In the following cases, a buzzer will sound a single long beep and Adaptive Cruise Control is automatically canceled. Also, a pop-up screen will be displayed on the multi function display.

* Refer to page 81.

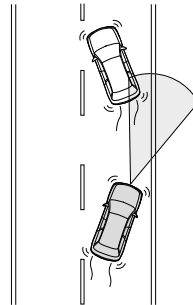
- The lead vehicle that your vehicle has been tracking within a distance of approximately 100 ft (30 m) and at a speed differential of approximately 20 MPH (30 km/h) or less is no longer detected. (At this time the lead vehicle indicator located in the meter display will flash.)
- The grade of the road is very steep.
- Vehicle Dynamics Control or Traction Control Function is activated.
- The vehicle speed has exceeded approximately 100 MPH (160 km/h) while cruise control is set.
- The steering wheel was turned significantly in either direction.
- The transmission select lever is moved to a position other than **D**.



S00648

- Cruise control can be resumed after the transmission select lever is returned to the **D** position.
 - A paddle shift switch is operated while driving when the transmission select lever is in the **D** position.
 - Cruise control can be resumed after the paddle shift is not operated for a while. (The shift position will return to the **D** position unless S# (Sports Sharp mode) of SI-DRIVE is selected on turbo models.)
 - Any door including the driver's door, passenger's door or rear door is opened.
 - The driver's seatbelt is unfastened.
 - The parking brake is engaged (when the brake warning light illuminates).
 - Vehicle Dynamics Control is turned off manually (VDC OFF indicator light illuminates).
 - Cruise control can be used again when Vehicle Dynamics Control is turned back on.
 - X mode is turned on (the X mode indicator light  illuminates).
 - Cruise control can be resumed after the X mode is turned off.
 - EyeSight operation has temporarily stopped.
- * Refer to page 77.
- EyeSight is malfunctioning (the EyeSight warning light “ ” illuminates).
- * Refer to page 76.

**WARNING**

Do not use Adaptive Cruise Control on slippery roads. Doing so may result in an accident.

**CAUTION**

If the selector lever is shifted to the **N** position, the Adaptive Cruise Control is automatically cancelled. However, do not shift the selector lever into the **N** position while driving except in an emergency. Doing so will eliminate the engine's tendency to brake the vehicle and may result in an accident.



NOTE

- If EyeSight operation has temporarily stopped, the Pre-Collision Braking System OFF indicator light and Lane Departure Warning OFF indicator light illuminate, and a symbol from “E1” to “E3” is displayed on the meter display when the main cruise control is on.
 - * Refer to page 77.
- Also, a pop-up screen is displayed on the multi function display.
 - * Refer to page 81.
- If EyeSight is malfunctioning, the EyeSight warning light and the Pre-Collision Braking System OFF indicator light and Lane Departure Warning OFF indicator light will illuminate. A pop-up screen will be displayed on the multi function display. If this occurs, stop the vehicle in a safe location and then turn off the engine and restart it. If the indicators remain illuminated after restarting the engine, Adaptive Cruise Control cannot be used. This will not interfere with ordinary driving; however the system should be inspected by a SUBARU dealer as soon as possible.
 - * Refer to page 76.
- When the operation of Adaptive Cruise Control has been automatically canceled, perform the set cruise control operation again after the condition that caused the cancellation has been corrected. If the cruise control function cannot be set even after the condition has been corrected, EyeSight may be malfunctioning. This will not interfere with ordinary driving; however the system should be inspected by a SUBARU dealer as soon as possible.

■ Resuming from temporal cancellation (returning to a vehicle speed that was previously set)

When the vehicle speed which was previously set is stored in memory, press the RES/+ switch to return to set that vehicle speed. (The screens that indicate the set condition will appear again on the meter display and the multi function display.)

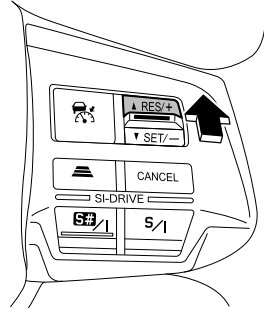

S00822

<Meter display>

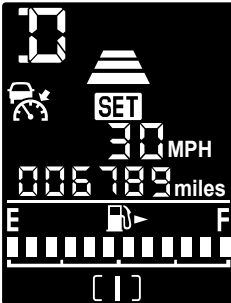

S00897

<Multi function display>

Canada only

(For USA: on the meter display)



S00898



NOTE

The vehicle speed stored in memory is erased in the following circumstances:

- The main cruise control was turned off by pressing the  (CRUISE) switch.
- Vehicle Dynamics Control or Traction Control Function are activated.
- The cruise control mode was switched from the Adaptive Cruise Control to the Conventional Cruise Control.

■ “Brake more” warning

The “brake more” warning is activated while Adaptive Cruise Control is tracking a lead vehicle.

The “brake more” warning warns the driver when it determines that deceleration by current driver braking control is insufficient.

When the ‘brake more’ function operates, the lead vehicle indicator will flash and a buzzer will sound several short beeps. In addition, a pop-up screen will be displayed on the multi function display (for Canada). For USA models, the warning message appears on the meter display, above the multi function display.

When this function activates, depress the brake pedal as necessary to decelerate and maintain a correct following distance.

<Meter display>

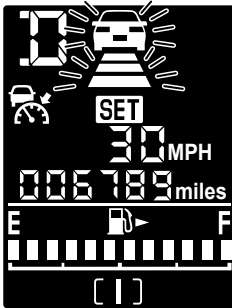

S00899

<Multi function display>

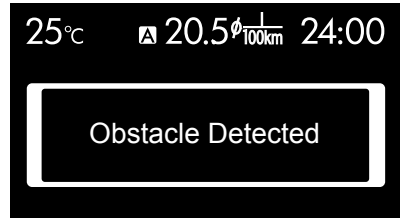

S00836

WARNING

- If the buzzer sounds frequently, do not use Adaptive Cruise Control.
- The “brake more” warning will not activate in the following situations.
 - The accelerator pedal is depressed.
 - The brake pedal is depressed adequately.
- Even when the following distance is short, the “brake more” warning may not activate in the following situations.
 - The difference in speed with the vehicle in front is small. (The two vehicles are travelling at almost the same speed.)
 - The vehicle in front is traveling faster than your vehicle. (The following distance is gradually increasing.)
 - Another vehicle cuts into your lane very close to your vehicle.
 - The vehicle in front decelerates suddenly.
 - When there are repeated uphill and downhill grades
- The “brake more” warning may not activate in time in the case of a vehicle that is stopped at the end of a line at a toll gate, at a stop light or intersection or in traffic congestion, or a vehicle that is moving much slower than your vehicle.

Pre-Collision Braking System

When there is the risk of a rear-end collision with an obstacle in front, the EyeSight system helps to minimize or prevent a collision by warning the driver. If the driver still does not take evasive action to avoid a collision, the brakes can be automatically applied just before the collision in order to reduce impact damage, or if possible, prevent the collision. When the system determines that there is a high risk of collision with an obstacle ahead, and the driver depresses the brake pedal, the system activates braking assist. (Pre-Collision Brake Assist)

This system can be effective not only with frontal collisions, but also with offset (right or left) collisions. This function can be activated when the select lever is in the D, M or N positions.



- Never use the Pre-Collision Braking System and Pre-Collision Brake Assist to stop your car under ordinary conditions. The Pre-Collision Braking System cannot prevent collisions under all conditions. If the driver relies only on the Pre-Collision Braking System for Brake operation, collisions may occur.
- When a warning is activated, pay attention to the front of the vehicle and its surroundings, and operate the brake pedal and/or take other actions if necessary.
- The EyeSight Pre-Collision Braking System function is primarily designed to prevent rear-end collisions with other vehicles when possible and to minimize damage and injuries in the event of a collision. In addition to other vehicles, things such as motorbikes, bicycles and pedestrians can also be treated as obstacles. However, there may be cases when detection is not possible depending on a variety of conditions*. It is highly probable that the Pre-Collision Braking System function does not work against vehicles parked in a lateral position, oncoming vehicles, backing up vehicles, small animals, infants, fences, walls, gates, etc.
- The Pre-Collision Braking System function will operate at the point when it determines that a collision cannot be avoided and is designed to apply strong braking force just before a collision. The result of this varies depending on a variety of conditions*. Because of this, performance of this function will not always be the same.
- When the Pre-Collision Braking System function is activated, it will continue to operate even if the accelerator pedal is partially depressed. However, it will be canceled if the accelerator pedal is fully depressed.
- If the driver depresses the brake pedal or turns the steering wheel, the system may determine that this constitutes evasive action by the driver, and the automatic braking control may not activate in order to allow the driver full control.
- When the difference in speed with the obstacle in front is approximately 20 MPH (30 km/h) or more, it may not be possible to avoid a collision. Even if the speed difference is approximately 20 MPH (30 km/h) or less, in cases such as when another vehicle cuts in front of you, or in other cases depending on visibility, condition of road surface and other factors*, the function may be unable to stop the vehicle or may not activate. Pre-Collision Brake Assist may also not activate depending on the conditions* listed below.

*Conditions

- Distance to obstacle in front of you, speed difference, proximity conditions, lateral displacement (the amount of offset)
- Vehicle conditions (amount of load, number of occupants, condition of tires, etc.)
- Road conditions (grade, slipperiness, shape, bumps, etc.)
- When visibility ahead is poor (rain, snow, fog or smoke, etc.)
- When the detected object is one of the following
 - A domestic animal or other animal (a dog or deer, etc.)
 - A guardrail, telephone pole, tree, fence or wall, etc.

Continued on next page ⇒

⇒ Continued from previous page

- Even if the obstacle is a motorcycle, bicycle or pedestrian, depending on the brightness of the surroundings as well as the relative movement, and aspect or angle of the object, there may be cases when the system cannot detect it.
- When the system determines that operation by the driver (based on accelerator pedal operation, braking, steering wheel angle, etc.) is intended as evasive action
- Vehicle maintenance status (brake systems, tire wear, tire pressure, whether a temporary spare tire is being used, etc.)
- When towing a trailer or vehicle, etc.
- When the brakes are cold due to outside temperature being low or just after starting the engine.
- When the brakes are overheated on downhill grades (braking effectiveness is reduced)
- When driving in rain or after washing the vehicle (the brakes are wet and braking effectiveness is reduced)
- Recognition conditions of the stereo cameras

In particular, the function may be unable to stop the vehicle or may not activate in the following cases.

- Bad weather (for example heavy rain, a blizzard or thick fog)
- When visibility is poor due to sand, smoke or water vapor in the air or when the vehicle in front or oncoming traffic causes water, snow, dirt, dust or other substances to obscure the view through the windshield
- When driving at night or in a tunnel without the headlights on
- When driving at night or in a tunnel when there is a vehicle in front that does not have its taillights on
- When approaching a motorcycle, bicycle or pedestrian at night
- When ambient light is poor in the evening or early morning
- When a vehicle, motorcycle, bicycle or pedestrian is outside the area illuminated by the headlights
- When affected by strong light from the front (for example, sunlight at dawn, sunset or headlight high beams, etc.)
- When there is snow, frost, dirt or dust on the windshield or it is clouded
- When fluid has not been fully wiped off the windshield during or after washer use
- When the target cannot be correctly recognized because the stereo cameras' view is obstructed by water droplets from rain or the window washer, or by the wiper blades.
- When the stereo cameras' field of view is obstructed (for example by a canoe on the roof of the vehicle)

• When the rear aspect of the vehicle in front is low, small or irregular (the system may recognize another part of the vehicle as its rear and will determine operation from that)

- When there is an empty truck or trailer with no rear and/or side panels on the cargo bed
- With vehicles that have cargo protruding from their back ends
- With non-standard shaped vehicles (vehicle transporters or vehicles with a sidecar fitted, etc.)
- When the height of the vehicle is low, etc.

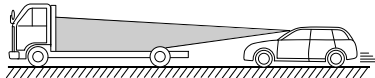

S00654

- When there is a wall, etc. in front of a stopped vehicle
 - When there is another object near the vehicle
 - When a vehicle, etc. is stopped in the lateral direction
 - With vehicles that are backing up or with oncoming vehicles, etc.
 - When the size and height of an obstacle is smaller than the limitations of the stereo cameras' recognition capability
 - With small animals or children, etc.
 - With pedestrians who are sitting or lying down
 - When the detected object is a fence, wall or shutter, etc.
 - When there is a wall or door made of glass or a mirror in front
 - When the vehicle in front suddenly swerves, accelerates, or decelerates.
 - When a vehicle, motorcycle, bicycle or pedestrian cuts in from the side or jumps out suddenly
 - When you suddenly change lanes and your vehicle is immediately behind an obstacle
 - When there is a vehicle, motorbike, bicycle or pedestrian in a location extremely close to your vehicle
 - When the speed difference between your vehicle and an obstacle is 4 MPH (5 km/h) or less (As braking is performed once the obstacle is in close proximity to your vehicle, depending on the shape and size of the obstacle, there may be some cases when the obstacle is outside the range of the cameras' field of vision.)
 - When driving on sharp curves, steep uphill grades or steep downhill grades
 - When driving on a bumpy or unpaved road
 - When passing through the entrance or exit of a tunnel
- For your safety, do not test the Pre-Collision Braking System function by yourself. There is a possibility that the vehicle will not stop or the function will not work during the test and this may cause an unexpected accident.
- The system may not operate correctly under the conditions listed below. When these conditions occur, turn off the Pre-Collision Braking System.
- The tire pressure is not correct.*
 - A temporary spare tire is installed.*
 - Tires that are worn or have large variations in wear conditions.*
 - Tires other than those of the designated size are installed.*
 - Flat tires are repaired using the flat tire repair kit.
 - The suspension has been modified.
 - Tire chains are installed.
 - The headlights are dirty or are not aligned correctly. (Objects are not correctly illuminated and are difficult to detect.)
 - Vehicle operation has become compromised due to an accident or malfunction.
 - The brake warning light is illuminated.
 - The vehicle is tilted due to a heavy cargo load.
 - The maximum number of occupants and/or the gross vehicle weight rating has been exceeded.

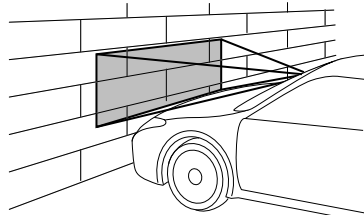

S00653

*The wheels and tires have functions that are critically important. Be sure to use the correct parts. For details, refer to the Owner's Manual for your vehicle.

CAUTION

- In the following situations, turn off the Pre-Collision Braking System. Otherwise the Pre-Collision Braking System may activate unexpectedly.
 - When the vehicle is being towed
 - When loading the vehicle onto a carrier
 - When a chassis dynamometer, free-rollers or similar equipment is used
 - When a mechanic lifts up the vehicle, starts the engine and spins the wheels freely
 - When passing hanging banners, flags or branches, or when thick/tall vegetation is contacting the vehicle
 - When using a drive-through car wash

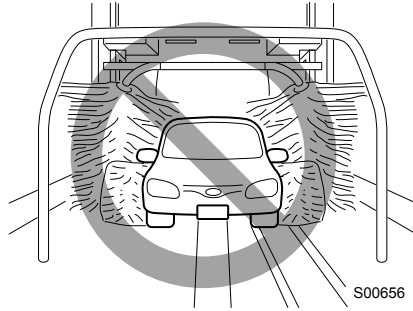

- The Pre-Collision Braking System may activate in the following situations. Therefore concentrate on safe driving.
 - When passing through an automatic gate (opening and shutting)
 - When driving close to the vehicle in front
 - When driving in a location where the grade of the road changes rapidly

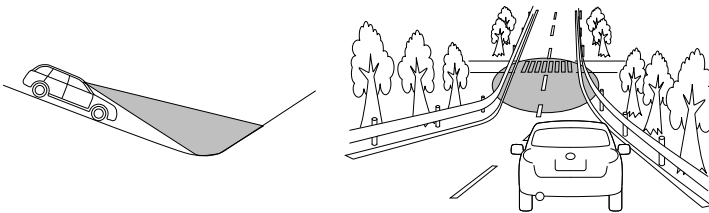

- When passing through clouds of steam or smoke
- When the exhaust gas emitted by the vehicle in front is clearly visible in cold weather, etc.

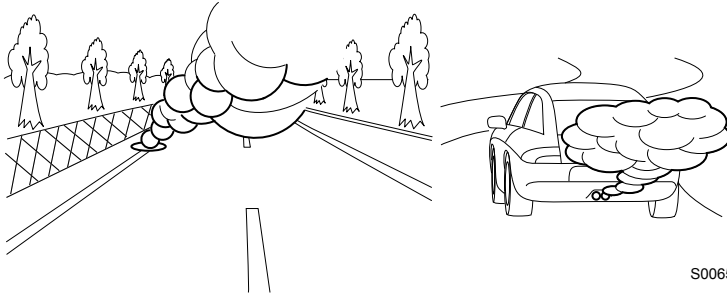

S00652

- When there is an obstacle on a curve or intersection
- When narrowly passing a vehicle or an object
- When stopping very close to a wall or a vehicle in front
- If there is cargo or installed accessories, etc. that are protruding over the edge of the front bumper, the vehicle's length will increase and the system may not be able to prevent a collision.

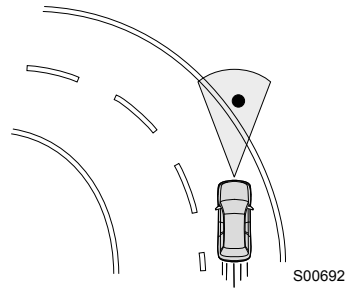

S00692

- If the driver operates the brake pedal during automatic braking, the pedal may feel stiff; however, this is normal. By depressing the brake pedal further you can apply more braking force.

**NOTE**

- When the Pre-Collision Braking System OFF indicator light illuminates, this function will not operate.
- * Refer to page 51.
- Some unusual noises may be audible during automatic braking. This is caused by the braking control and is normal.

■ Detection of pedestrians

The EyeSight system can also detect pedestrians. The EyeSight system detects pedestrians from their size, shape and movement. The system detects a pedestrian when the contour of the head and shoulders are clear and the left/right balance is symmetrical.

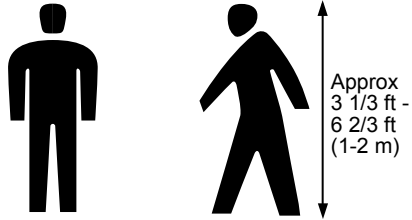

S00693



WARNING

The EyeSight system's Pre-Collision Braking function also treats pedestrians as obstacles. However, depending on the conditions, there may be cases when the system cannot detect a pedestrian. In the following conditions, the possibility that the system may not be able to detect a pedestrian as an object is particularly high.

- When pedestrians are walking in a group
- When a pedestrian is next to a wall or other obstacle
- When a pedestrian is using an umbrella
- When a pedestrian is wearing clothes that are a similar color to the surrounding environment
- When a pedestrian is carrying bulky luggage
- When a pedestrian is bent over, crouching down or lying down
- When a pedestrian is in a dark location
- When a pedestrian suddenly jumps out into the field of view

Pre-Collision Braking System operation

When there is an obstacle in the forward direction during driving, the system activates in the following sequence in order to warn the driver, activate braking control, and activate the brake lights.

(1) Following Distance Warning:

When the system determines that there is a risk of collision, a buzzer sounds repeated short beeps and the indicators on the meter display and the multi function display illuminate to warn the driver.

The Following Distance Warning operates when Adaptive Cruise Control is not set.

When the driver depresses the brake pedal to decelerate and achieves a suitable following distance, the warning is canceled.

(2) First Braking and Warning:



When the system determines that there is a high risk of collision with an obstacle in front, a buzzer sounds repeated short beeps and the indicators on the meter display and the multi function display illuminate to warn the driver, and braking control is activated. If the system determines that the amount of evasive action (braking, steering, etc.) taken by the driver has reduced the risk of collision, braking activation is canceled.

(3) Second Braking and Warning:

If the system then determines that the risk of collision is extremely high, the buzzer changes to a continuous beeping sound and stronger braking control is activated. If, despite any evasive action taken by the driver, the system subsequently determines that a collision is unavoidable, braking control is continued.

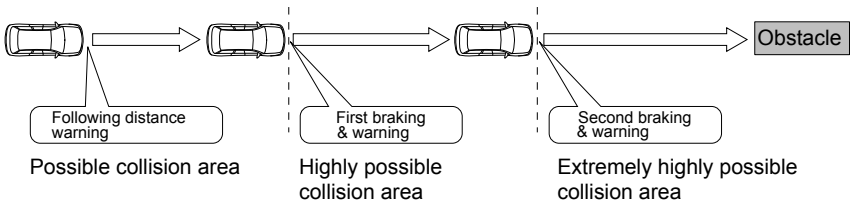
When the vehicle stops, a buzzer sounds three short beeps and a single long beep. The automatic braking function is cancelled approximately 2 seconds after the vehicle stops and the vehicle starts creeping forward gradually.



Operating system	Strength of Automatic Braking	Meter display	Multi function display	Warning buzzer type
Following distance warning	No brake control	 (Flash)	Canada only	Short beeps
First braking & warning	Moderate		 (For USA: on the meter display)	Repeated short beeps
Second braking & warning	Strong		Continuous beep	



CAUTION

The Pre-Collision Braking System will not activate when the EyeSight warning light () is illuminated or flashing, or when the EyeSight temporarily stops.



NOTE

Neither primary Pre-Collision Braking nor secondary Pre-Collision Braking will operate in the following conditions.

- When the vehicle speed is approximately 1 MPH (1 km/h) or lower, or approximately 100 MPH (160 km/h) or higher.
- When the Vehicle Dynamics Control is functioning.

Pre-Collision Braking Assist operation

When the Pre-Collision Braking System is activated utilizing first braking or second braking (when the system determines that there is a high risk of collision with an obstacle in front), if the driver depresses the brake pedal, the system determines that this is emergency braking and activates braking assist automatically.



CAUTION

If the driver depresses the brake pedal manually while following distance warning is activated, the Pre-Collision Braking Assist will not work. (The vehicle decelerates with the normal braking force operated by the driver.)



NOTE

- Pre-Collision Braking Assist function does not operate when the vehicle speed is approximately 7 MPH (10 km/h) or less or 100 MPH (160 km/h) or more.
- For information about the braking assist function, refer to the Owner's Manual for your vehicle.

Turning off the Pre-Collision Braking System

When pressing and holding the Pre-Collision Braking System OFF switch for approximately 2 seconds (or longer), a single short beep will sound and the Pre-Collision Braking System (including Pre-Collision Brake Assist) will turn off. When this control is turned off, the Pre-Collision Braking System OFF indicator light on the instrument panel illuminates. To turn the control back on, press and hold the Pre-Collision Braking System OFF switch for approximately 2 seconds or longer again. When this control is turned on, the Pre-Collision Braking System OFF indicator light will turn off.

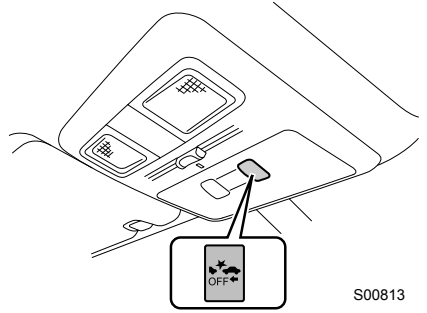

S00813



NOTE

- When the Pre-Collision Braking System is turned off, the Pre-Collision Throttle Management Control function is also turned off.
- Even when the Pre-Collision Braking System is turned off, if the ignition switch is turned off and the engine is then restarted, the Pre-Collision Braking System will be turned on. The system default setting when the vehicle is restarted in "ON".

Pre-Collision Braking System OFF indicator light

This indicator light illuminates when the ignition switch is turned to the ON position, and then flashes for approximately 7 seconds after the engine starts. It turns off when the Pre-Collision Braking System is turned off. It also illuminates under the following conditions.

- When the VDC OFF switch is pressed and VDC is canceled
- When the EyeSight system has a malfunction

* Refer to page 76.

- When the EyeSight system has stopped temporarily

* Refer to page 77.

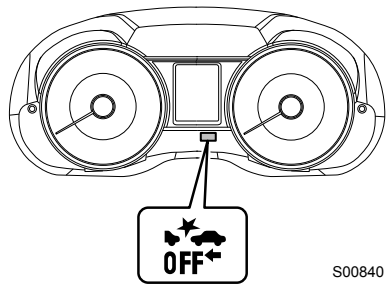

S00840

Pre-Collision Throttle Management

When an obstacle is detected in front of the vehicle, and the vehicle is stopped or traveling very slowly, if the system determines that the accelerator pedal has been depressed by more than the necessary amount (due to driver error), it greatly restricts engine output and ensures that vehicle forward movement is slower than normal in order to give the driver additional time to brake or react.

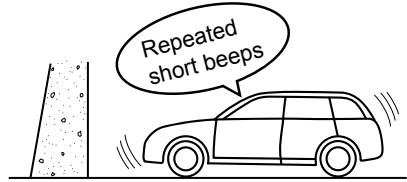

S00841

During system operation, a buzzer will sound several short beeps and the lead vehicle indicator and the following distance setting indicator will blink in the meter display. Also, a pop-up screen will be displayed in the multi function display.

This function only activates when the transmission select lever is in the **D** or **M** position.

<Meter display>

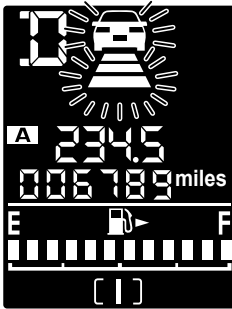

S01003

<Multi function display>

Canada only

(For USA: on the meter display)

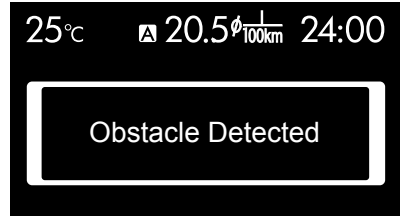

S00836



WARNING

Do not rely excessively on Pre-Collision Throttle Management. Pre-Collision Throttle Management is not designed to help you avoid collisions in many situations. Always check the selector lever and pedal positions as well as the surrounding environment before starting and operating the vehicle. Relying only on Pre-Collision Throttle Management could result in an accident.

- Pre-Collision Throttle Management is not designed to maintain the vehicle in a stopped condition.

- Pre-Collision Throttle Management will not reduce acceleration under all conditions. It is also not designed to prevent collisions.
 - Pre-Collision Throttle Management will operate when an obstacle is detected in front. However, this function will not reduce acceleration in cases where no obstacle is recognized (for example when approaching a cliff, etc.)
 - Do not intentionally depress the accelerator pedal excessively when there are obstacles nearby. If the driver relies only on Pre-Collision Throttle Management to control acceleration, collisions may occur.
 - If your vehicle is trapped on a railroad crossing and you are trying to escape by driving through the crossing gate, the stereo cameras may recognize the crossing gate as an obstacle and Pre-Collision Throttle Management system may activate. In this case, remain calm and either continue to depress the accelerator pedal or turn off the Pre-Collision Throttle Management system.
- * Refer to page 57.
- Pre-Collision Throttle Management may not activate depending on the following conditions:
 - The distance between your vehicle and the obstacle, speed difference, and lateral displacement (amount of offset)
 - Recognition status of the stereo cameras
 In particular, the function may not activate in the following cases:
 - Bad weather (for example heavy rain, a blizzard or thick fog)
 - When visibility is poor due to sand or smoke in the air
 - When light is poor in the evening, early morning, or at night
 - In a dark area (indoor parking area, etc.)
 - When there is an obstacle outside the area illuminated by the headlights
 - When affected by strong light from the front (for example sunlight at sunrise or sunset headlight high beams, etc.)
 - When there is snow, frost, dirt or dust on the windshield, or it is clouded
 - When fluid has not been fully wiped off the windshield during or after use of the window washer
 - When obstacles cannot be correctly recognized due to water droplets from rain or the washer, or the wiper blades obstructing the stereo cameras' field of view
 - When the stereo cameras' field of view is obstructed (for example by a canoe on the roof of the vehicle)
 - With low obstacles (low wall, crash barrier, low vehicle, etc.)
 - When the size and height of an obstacle is smaller than the limitations of the stereo cameras' recognition capability
 - With small animals or children
 - With pedestrians who are sitting or lying down

Continued on next page ⇒

⇒ Continued from previous page

- When the rear aspect of the vehicle or object in front is small (for example a trailer, oncoming vehicle, etc.) or when your vehicle is too close to it (the system may recognize another part of the vehicle as its rear end, and may not operate properly)

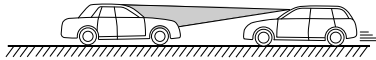
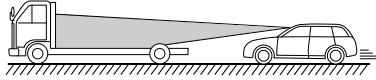

S00843

- When there is a fence, wall or shatter, etc., with a uniform pattern (striped pattern, brick, etc.) or with no pattern in front
- When there is a wall or door made of glass or a mirror in front

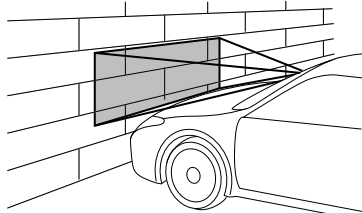

S00653

- When an obstacle (another vehicle, motorcycle, bicycle, pedestrian, animal or child, etc.) cuts in from the side or jumps out suddenly
- When starting, if you change lanes and your vehicle is immediately behind the obstacle
 - On sharp curves, steep uphill grades or steep downhill grades
 - When the system determines that steering operation by the driver is intended as evasive action
- For your safety, do not test the Pre-Collision Throttle Management function by yourself. There is a possibility that the function will not work during the test and this may cause an unexpected accident.

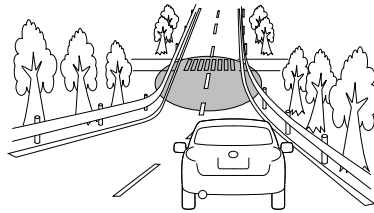
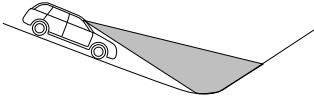

CAUTION

- In the following situations, turn off Pre-Collision Throttle Management. Otherwise Pre-Collision Throttle Management may activate unexpectedly.
 - When the vehicle is being towed
 - When loading the vehicle onto a carrier
 - When a chassis dynamometer, free-rollers or similar equipment is used
 - When a mechanic lifts up the vehicle, starts the engine and allows the wheels to spin freely
 - When passing hanging banners, flags or branches, or when thick/tall vegetation is contacting the vehicle
 - When performing sport driving on a racetrack, etc.
- The Pre-Collision Braking System may activate in the following situations. Therefore concentrate on safe driving.
 - When your vehicle is close to the vehicle in front
 - When passing through an automatic gate
 - When your vehicle is in a location where the grade of the road changes rapidly

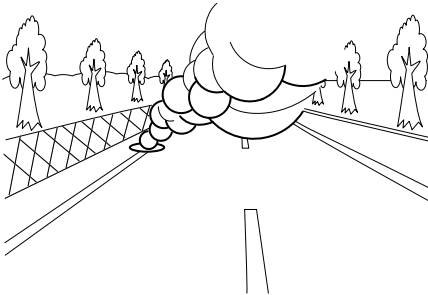

S00901

- When passing through clouds of steam or smoke



S00652

Continued on next page ⇒

⇒ Continued from previous page

- When there is an obstacle on a curve or intersection

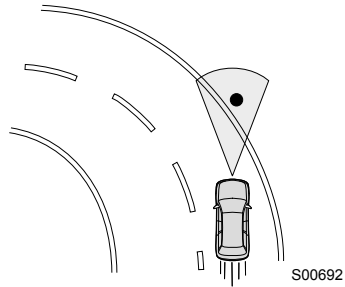

- When narrowly passing a vehicle or object
- When stopping very close to a wall or a vehicle in front



NOTE

When the Pre-Collision Braking System is turned off, Pre-Collision Throttle Management is also turned off.

* Refer to page 51.

Turning off Pre-Collision Throttle Management

When pressing and holding the Pre-Collision Braking System OFF switch for approximately 2 seconds or longer a single short beep will sound and the Pre-Collision Throttle Management System will turn off. When this function is turned off, the Pre-Collision Braking System OFF indicator light on the instrument panel illuminates.

To turn the system back on, press and hold the Pre-Collision Braking System OFF switch again for approximately 2 seconds or longer. When this function is turned on, the Pre-Collision Braking System OFF indicator light turns off.

* Refer to page 51.

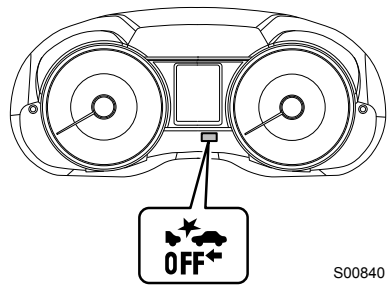
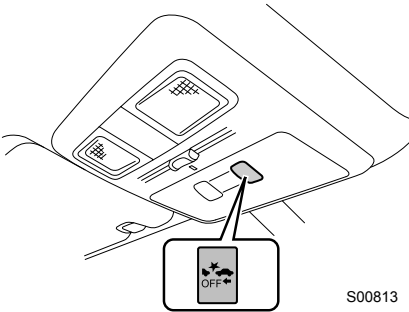

NOTE

- When Pre-Collision Throttle Management is turned off, the Pre-Collision Braking System also turns off.
- Even when Pre-Collision Throttle Management is turned off, if the ignition switch is turned off and the engine is restarted, Pre-Collision Throttle Management will be turned on. The default setting for Pre-Collision Throttle Management when the vehicle is restarted is "ON".

Lane Departure Warning

When vehicle speed is approximately 32 MPH (50 km/h) or more, this function warns the driver if the system detects that the vehicle is likely to depart the traffic lane.

When Lane Departure Warning activates, a buzzer sounds 6 short beeps, and the steering wheel indicator and right/left lane indicators on the meter display all flash at the same time. Also, a pop-up screen will be displayed on the multi function display.

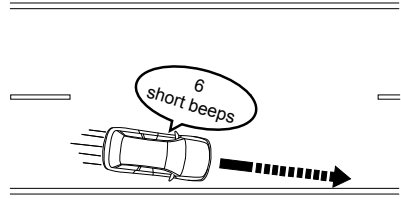

S00649

<Meter display>

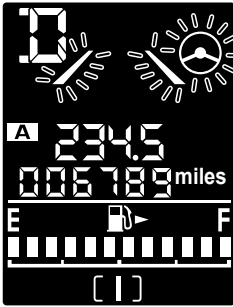

S01004

<Multi function display>

Canada only

(For USA: on the meter display)

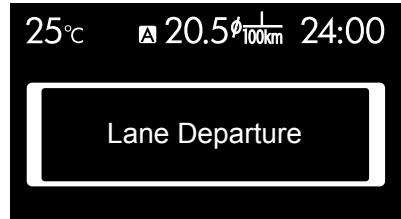

S00846

The Lane Departure Warning will activate at a faster rate than usual if lane sway was not avoided after the warning buzzer activated.

* Refer to page 61.



WARNING

Lane Departure Warning will not operate in all conditions. It also will not automatically return the vehicle to the original lane. If the driver relies only on the Lane Departure Warning to keep the vehicle in the lane, lane departure may occur, resulting in an accident.

The Lane Departure Warning activates when it detects lane markings. However, it is not a function which can detect the edge of a road (shoulders or side ditches, etc.) and warn the driver.

**CAUTION**

In the following situations, the Lane Departure Warning will or may not activate:

- Vehicle speed is approximately 32 MPH (50 km/h) or less.
- For approximately 7 seconds after the Lane Departure Warning activates once
 - When the steering wheel is turned significantly to either side
 - When the brake pedal is depressed or immediately after it is depressed
 - When the accelerator pedal is almost fully depressed and the vehicle is accelerating or immediately after accelerating
 - When the following distance behind a vehicle in front is short
 - While the turn signal is operating and for approximately 7 seconds after the turn signal lever has returned to its original position
 - When the vehicle has not returned to the inside of the lane after the Lane Departure Warning has activated
- The lane is narrow.
- When it is difficult for the camera to detect lane markings
 - There are no lane markings (white lines, etc.) or they are very worn.
 - It is difficult to detect lane markings as they are similar in color to the road surface.
 - The lane markings are narrow.
- When the lead vehicle has taken measures to avoid an obstacle and following this you have performed steering operations

**NOTE**

- The following situations may cause incorrect lane detection and a faulty Lane Departure Warning to occur.
 - Tire tracks on a wet road or snow-covered road
 - Boundaries between snow and asphalt, marks from road repair, etc.
 - Double lane lines, etc.
 - Shadows of guardrails, etc.
 - When the Lane Departure Warning OFF indicator light is illuminated, the Lane Departure Warning is inactive.
- * Refer to page 60.

Turning off Lane Departure Warning

When pressing and holding the Lane Departure Warning OFF switch for approximately 2 seconds or longer, a single short beep will sound and the Lane Departure Warning will turn off. When this function is turned off, the Lane Departure Warning OFF indicator light on the instrument panel will illuminate.

To turn the function back on, press and hold the Lane Departure Warning OFF switch again. When the function is turned on, the Lane Departure Warning OFF indicator light will turn off.

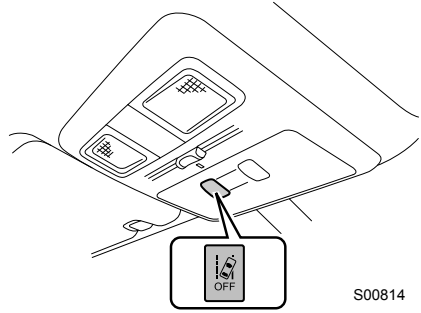

S00814



NOTE

- When the Lane Departure Warning is turned off, the Lane Sway Warning is also turned off.
- Even when the Lane Departure Warning is turned off, if the ignition switch is turned off and then the engine is restarted, the Lane Departure Warning will be turned on. The default setting for the Lane Departure Warning when the vehicle is restarted is "ON".

■ Lane Departure Warning OFF indicator light

This indicator illuminates when the ignition switch is turned to the ON position, and then approximately 7 seconds after the engine starts, it turns off depending on the current status (ON or OFF). It turns off when the Lane Departure Warning is turned off.

It also illuminates under the following conditions.

- When the VDC OFF switch is pressed and VDC is canceled
- When the EyeSight system has a malfunction
- * Refer to page 76.
- When the EyeSight system has stopped temporarily
- * Refer to page 77.

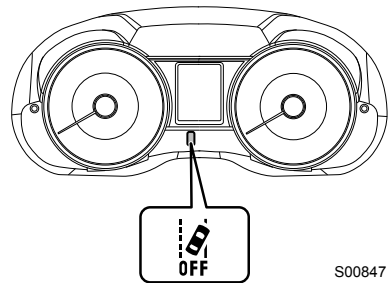

S00847

Lane Sway Warning

This function detects wandering or drifting within a lane, and warns the driver. When Lane Sway Warning activates, a buzzer sounds 6 short beeps, the steering wheel indicator flashes and the lane indicators flash alternately left/right on the meter display. Also, a pop-up screen will be displayed on the multi function display.

This function activates only when the vehicle speed is approximately 32 MPH (50 km/h) or more.

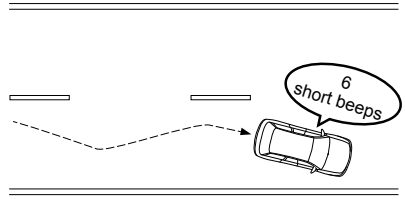

S00650

<Meter display>

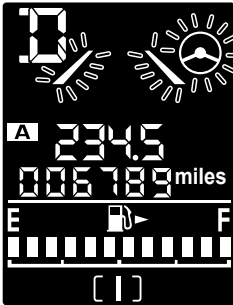

S01004

<Multi function display>

Canada only

(For USA: on the meter display)

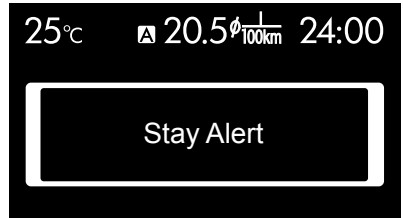

S00849

WARNING

Lane Sway Warning will not operate in all conditions. It also will not automatically correct wandering. If the driver relies only on the Lane Sway Warning to prevent the vehicle from wandering, an accident may occur.

CAUTION

Under the following conditions, the Lane Sway Warning may not operate.

- When driving on a winding road
- When vehicle speed changes greatly
- Immediately after a lane change
- When it is difficult for the EyeSight stereo cameras to detect lane markings
 - There are no lane markings (white lines, etc.) or they are the very worn.
 - It is difficult to detect lane markings as they are similar in color to the road surface.
 - The lane markings are narrow.



NOTE

- Wandering detection is based on several minutes of driving data. Wandering will not be detected immediately when it occurs. In addition, the warning may continue for some time even after wandering stops.
- The Lane Sway Warning System may also issue a warning when the driver is tired, not concentrating on the road or otherwise not paying adequate attention to driving. It is recommended that you be sure to take rest breaks as often as needed.
- When the Lane Departure Warning OFF indicator light is illuminated, Lane Sway Warning is inactive.

* Refer to page 60.

Turning off Lane Sway Warning

Press and hold the Lane Departure Warning OFF switch for approximately 2 seconds or longer to turn off the Lane Sway Warning. When this function is turned off, a single short beep sounds and the Lane Departure Warning OFF indicator light on the instrument panel illuminates.

To turn the function back on, press and hold the Lane Departure Warning OFF switch again for approximately 2 seconds or longer. When the function is turned on, the Lane Departure Warning OFF indicator light turns off.

* Refer to page 60.

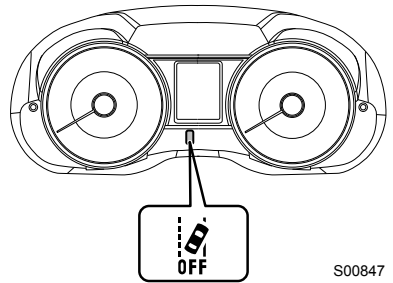
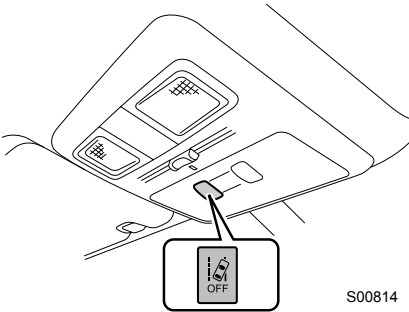

NOTE

- When the Lane Sway Warning is turned off, the Lane Departure Warning is also turned off.
- Even when the Lane Sway Warning is turned off, if the ignition switch is turned off and then the engine is restarted, the Lane Sway Warning will be turned on. The default setting for the Lane Sway Warning after the vehicle is restarted is "ON".

Lead Vehicle Start Alert

This function notifies the driver by means of a buzzer and the lead vehicle indicator on the multi information display when the driver's vehicle remains stopped after the vehicle in front has started to move forward. When the vehicle in front remains stopped continuously (within a following distance of approximately 32 ft (10 m) and the driver's vehicle remains stopped for several seconds or longer), the system continues to detect the vehicle in front and this alarm activates if the vehicle in front

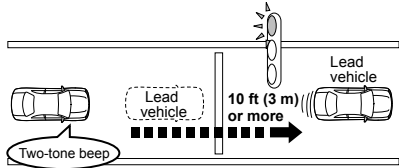

S00632

advances approximately 10 ft (3 m) or more while the driver's vehicle remains stationary.

This function only activates when the select lever is in the **D**, **M** or **N** position.

When the Lead Vehicle Start Alert activates, a buzzer sounds a two-tone beep and the lead vehicle indicator on the meter display flashes. Also, a pop-up screen will be displayed on the multi function display.

<Meter display>

<Multi function display>

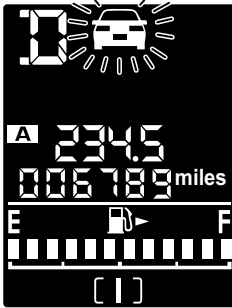

S01005

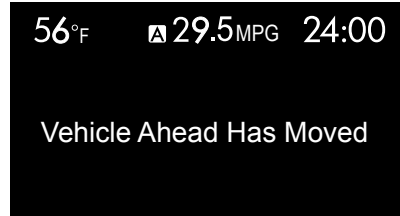

S00906



NOTE

- The Lead Vehicle Start Alert function setting can be turned on or off.
- * Refer to page 79.
- Under the following conditions, the Lead Vehicle Start Alert may activate even when the vehicle in front has not started to move, or may not activate even after the vehicle in front has started to move:
 - A motorcycle or similar object has cut in between your vehicle and the stopped vehicle in front.
 - Weather or road conditions prevent detection of the vehicle in front.
 - The EyeSight stereo cameras lose detection of the vehicle in front.
 - This function will not activate when the select lever is in the **D**, **M** or **N** position and the driver has not manually depressed the brake pedal.

Conventional Cruise Control

About Conventional Cruise Control

Conventional Cruise Control is a driving support system intended to allow more comfortable driving on expressways, freeways and interstate highways. It can be used to travel at a constant speed by maintaining the vehicle speed that was set by the driver (approximately 25 MPH (40 km/h) to 90 MPH (145 km/h)). Please remember that you should not exceed posted speed limits.





WARNING

- When Conventional Cruise Control is functioning, the system does not perform tracking control to maintain following distance, as when using Adaptive Cruise Control.
Strive for safe driving and operate the brake pedal to decelerate the vehicle as necessary in order to ensure a safe following distance from the vehicle in front.
- Under the following conditions, do not use the Conventional Cruise Control. Doing so may result in an accident.
 - Roads with heavy traffic or roads with sharp curves
You may fail to drive at a speed that is appropriate for the road conditions, possibly resulting in an accident.
 - Frozen roads, snow-covered roads or slippery road surfaces
The tires may spin, causing loss of control of the vehicle.
 - Steep downhill grades
The set vehicle speed may be exceeded.
 - On a steep continuous downhill grade
The brakes may overheat.
 - When towing a trailer.



CAUTION

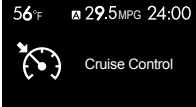

When using Cruise Control, be sure to check the display screen to confirm which Cruise Control mode is selected: Adaptive Cruise Control or Conventional Cruise Control.

	Meter display	Multi function display
Adaptive Cruise Control		
Conventional Cruise Control		

S00907



NOTE

- When the  (CRUISE) switch is first turned on, the Adaptive Cruise Control is set.
- To change the Cruise Control mode, press and hold the  (following distance setting) switch for approximately 2 seconds or longer. (This is effective only when the main Cruise Control is on and neither Adaptive Cruise Control nor Conventional Cruise Control are set.)
- Even when the EyeSight function temporarily stops, the Conventional Cruise Control can be used.





How to use the Conventional Cruise Control

Conventional Cruise Control can be set when the following conditions are met.

- The select lever is in the  position.
- The brake pedal is released.
- The vehicle speed is between approximately 25 MPH (40 km/h) and 90 MPH (145 km/h).

■ When setting Conventional Cruise Control

(1) Setting the Conventional Cruise Control to standby status.

Press the  (CRUISE) switch. At this time,  (Adaptive Cruise Control) and the  (following distance setting) are displayed on the EyeSight display in the meter display. The trip meter changes to the set vehicle speed display, and it will read “- - - MPH (USA) or km/h (Canada)”. When the  (CRUISE) switch is pressed, the initial cruise control mode is always Adaptive Cruise Control.

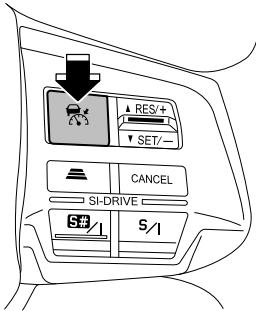

S00815



EyeSight display

READY display



S00886

If the switch is pressed once more, the EyeSight display will turn off. It will also automatically turn off when the engine is stopped.



NOTE

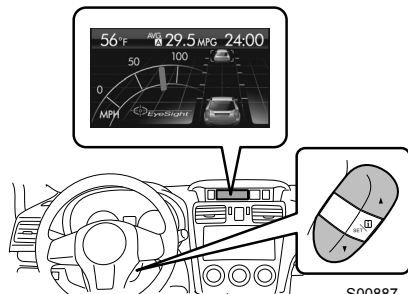

When the main cruise control is turned on by pressing the  (CRUISE) switch, the multi function display will switch to the EyeSight screen.

To return to the triple meter or clock display, pull the   switch on the steering wheel toward you.



S00887

Conventional Cruise Control

- (2) Press and hold the  (following distance setting) switch for approximately 2 seconds or longer to switch from Adaptive Cruise Control to Conventional Cruise Control. A buzzer sounds 1 short beep. At this time, the following distance setting indicator will turn off and the  (Conventional Cruise Control) will be displayed on the meter display and at the same time the multi function display will switch to another screen.

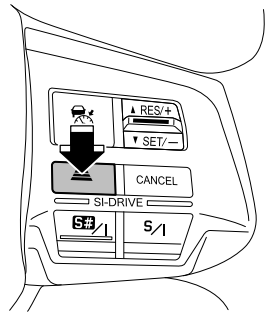

S00829

<Meter display>

<Multi function display>

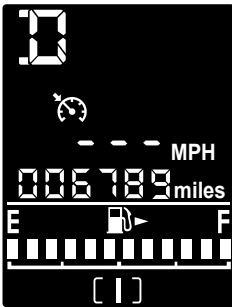

S00908

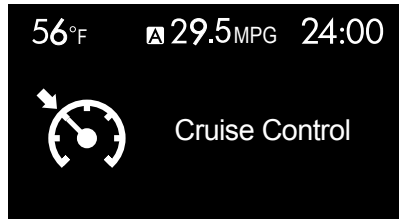

S00909

- (3) Depress or release the accelerator pedal to adjust the vehicle speed to the desired speed.
- (4) When the vehicle speed has reached the desired speed, press the “SET/-” switch. The vehicle speed at the time the switch is pressed becomes the set vehicle speed, and constant-speed driving is engaged. The **SET** indicator is displayed on the meter display.

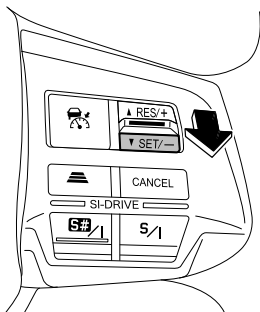

S00818



S00910



**WARNING**

The "brake more" warning will not activate while Conventional Cruise Control is functioning.

**CAUTION**

During Conventional Cruise Control use, accelerator and brake control to track the vehicle in front is not performed. Operate the accelerator and brake pedals as necessary.

**NOTE**

- The set vehicle speed can be adjusted between 25 MPH (40 km/h) and 90 MPH (145 km/h).
- During Conventional Cruise Control use, the set vehicle speed is not shown on the multi function display.
- On a downhill grade, automatic braking may operate in order to maintain the set vehicle speed.
- To return to Adaptive Cruise Control use, cancel the Conventional Cruise Control then press and hold the  (following distance setting) switch for approximately 2 seconds or longer.
- For turbo models, when the vehicle speed is set while S# (Sports Sharp mode) of SI-DRIVE is selected, the gear shift position display in the meter switches from the current gear position to the  position.

■ Increasing the set vehicle speed

● Using the RES/+ switch

- Pressing the RES/+ switch briefly
Every time you press the RES/+ switch, the set vehicle speed will increase by 5 MPH (5 km/h).
- Pressing the RES/+ switch continuously
While pressing the RES/+ switch, the set vehicle speed will increase by 1 MPH (1 km/h).

When the switch is operated, the set vehicle speed on the meter display will change.

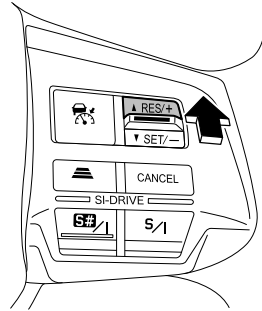

S00822

● Using the accelerator pedal

Operate the accelerator pedal to increase the vehicle speed.

When the desired speed is reached, press the SET/- switch. The vehicle speed is set at the speed when the switch is pressed, and the new set vehicle speed will be displayed on the meter display.

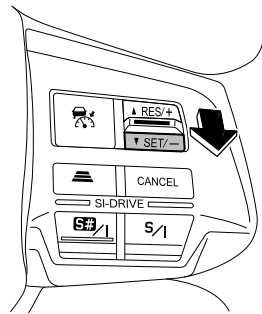

S00818

■ Decreasing the set vehicle speed

● Using the SET/- switch

- Pressing the SET/- switch briefly
Every time you press the SET/- switch, the set vehicle speed decreases by 5 MPH (5 km/h).
- Pressing the SET/- switch continuously
While pressing the SET/- switch, the set vehicle speed decreases by 1 MPH (1 km/h).

When the switch is operated, the set vehicle speed on the meter display will change.

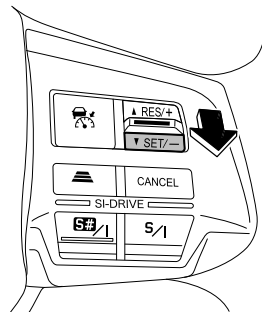

S00818

● Using the brake pedal

Depress the brake pedal to decrease the vehicle speed. (This cancels Conventional Cruise Control.)

When the desired speed is reached, press the SET/- switch. The vehicle speed is set at the speed when the switch is pressed, and the new set vehicle speed will be displayed on the meter display.

■ Accelerating temporarily

Depress the accelerator pedal to accelerate temporarily.

When the accelerator pedal is released, the vehicle returns to the set vehicle speed.



NOTE

For turbo models, the shift position indicator on the meter display will change from the **D** position to the current gear position when the accelerator pedal is depressed.

■ Decelerating temporarily

Depress the brake pedal to decelerate temporarily. (This cancels Conventional Cruise Control.)

The set vehicle speed on the meter display remains to be displayed and will switch to the standby mode (the SET indicator disappears).

To restore the set vehicle speed, press the RES/+ switch.



S00911

■ Canceling Conventional Cruise Control

● Cancellation by driver operation

- Press the CANCEL switch.
- Depress the brake pedal.

The set vehicle speed on the meter display remains to be displayed and will switch to the standby mode (the SET indicator disappears).

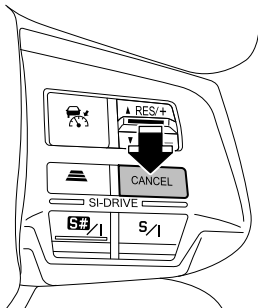

S00831



S00911

Conventional Cruise Control



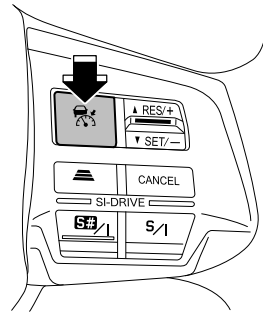

- Press the  (CRUISE) switch.

The EyeSight display in the meter will disappear and the Conventional Cruise Control will turn off.



● Automatic cancellation by the system

In the following cases, a buzzer sounds a single long beep and the Cruise control function is automatically canceled.

- The select lever was moved to a position other than .
 - The cruise control function can be used again after the lever is returned to the  position.
- A paddle shift switch was operated during driving with the lever in the  position.
 - The cruise control function can be used again after the paddle shift switch will not be operated for a while. (The shift position will return to the  position unless S# (Sports Sharp mode) of SI-DRIVE is selected on turbo models).
- Vehicle Dynamics Control was turned off.
 - The cruise control function can be used again when Vehicle Dynamics Control is turned back on.
- X-mode is turned on. (The X-mode indicator  illuminates.)
 - The cruise control function can be used again when X-mode is turned off.
- Vehicle speed drops to approximately 20 MPH (30 km/h) or less (due to a steep uphill grade or some other reason).
- Vehicle speed rises to approximately 100 MPH (160 km/h) or more (due to a steep downhill grade or some other reason).
- The Vehicle Dynamics Control or Traction Control functions activate.
- Any door of the driver's, front passenger's and rear doors is opened.
- The driver's seatbelt is unfastened.
- The parking brake is engaged (when the brake warning light illuminates).
- EyeSight is malfunctioning. (Refer to page 76, "EyeSight malfunction and temporary stop".)
- The steering wheel is turned significantly in either direction.
- The grade of the road is steep.



WARNING

Do not use Conventional Cruise Control on slippery roads. Doing so may result in an accident.

**CAUTION**

If the selector lever is shifted to the **[N]** position, the Conventional Cruise Control will automatically be cancelled. However, do not shift the selector lever into the **[N]** position while driving except for an emergency. Doing so will eliminate the engine's tendency to brake the vehicle.

**NOTE**

- If EyeSight is malfunctioning, the EyeSight warning indicator light, Pre-Collision Braking System OFF indicator light and Lane Departure Warning OFF indicator light illuminate. Also, a pop-up screen will be displayed on the multi function display. If this occurs, stop the vehicle in a safe location and then stop the engine and restart it. If the indicators remain illuminated after restarting the engine, Conventional Cruise Control cannot be used. This will not interfere with ordinary driving; however the system should be inspected by a SUBARU dealer as soon as possible.
 - * Refer to page 76.
- When operation of Conventional Cruise Control has been automatically canceled, perform the set operation again after the condition that caused the cancellation has been eliminated. If cruise control cannot be set even after the condition has been corrected, EyeSight may be malfunctioning. This will not interfere with ordinary driving; however the system should be inspected by a SUBARU dealer as soon as possible.

■ Resuming from temporary cancellation (resetting the set vehicle speed)

To recall and set a vehicle speed that has been previously set, press the RES/+ switch. (The meter display shows the set condition again.)

Resume is possible when a vehicle speed was previously set, and the current vehicle speed is approximately 20 MPH (30 km/h) or more.

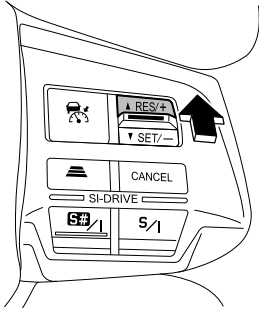

S00822



S00910



NOTE

- The vehicle speed stored in memory is erased at the following times:
 - The main cruise control was turned off by pressing the  (CRUISE) switch.
 - Either vehicle Dynamics Control or Traction Control Function has been activated.
 - The cruise control mode was switched from Conventional Cruise Control to Adaptive Cruise Control.
- The vehicle will drive at a constant speed that was set between approximately 25 MPH (40 km/h) and 90 MPH (145 km/h).
- If there is no vehicle speed in the memory (a previously set vehicle speed), the vehicle speed cannot be resumed by depressing the RES/+ switch.

List of buzzer sounds

Buzzer sound	Status	Reference page
Single continuous beep	Pre-Collision Braking System: Second Braking and alarm are active.	☆ Refer to page 49.
3 short beeps and single long beep	Pre-Collision Braking System: Automatic brake is cancelled after the vehicle has been stopped with the operation of Second Braking and alarm.	☆ Refer to page 49.
	Adaptive Cruise Control: Automatic brake is cancelled after the vehicle has been stopped due to the stopping of the vehicle in front.	☆ Refer to page 37.
Single long beep	Adaptive Cruise Control or Conventional Cruise Control is automatically canceled.	☆ Refer to pages 38 and 72.
Repeated short beeps	Pre-Collision Braking System First Braking is active.	☆ Refer to page 49.
	Pre-Collision Braking System The following distance warning is active.	
	Pre-Collision Throttle Management is active.	☆ Refer to page 52.
	The "brake more" warning from Adaptive Cruise Control is active.	☆ Refer to page 42.
6 short beeps	The Lane Departure Warning is active.	☆ Refer to page 58.
	The Lane Sway Warning is active.	☆ Refer to page 61.
1 short beep	Either of the following occurred while Adaptive Cruise Control was set. - A vehicle in front is detected*. - A vehicle in front is no longer detected*.	☆ Refer to page 30.
	The cruise control mode (Adaptive Cruise Control ↔ Conventional Cruise Control) is changed.	☆ Refer to page 67.
	EyeSight is malfunctioning.	☆ Refer to page 76.
	EyeSight operation is temporarily stopped.	☆ Refer to page 77.
	The Pre-Collision Braking System is turned on or off.	☆ Refer to page 51.
	Lane Departure Warning is turned on or off.	☆ Refer to page 60.
Two-tone beep	Lead Vehicle Start Alert is active*.	☆ Refer to page 64.

*The buzzer that indicates when a lead vehicle is detected or when it is no longer detected (lead vehicle acquisition alert), as well as the Lead Vehicle Start Alert function can be turned on or off.

* Refer to page 79.

EyeSight malfunction and temporary stop

If a malfunction is detected in the EyeSight system, the indicators in the meter display and the multi function display inform the driver of the malfunction. Check the displayed contents and take the appropriate action.

■ Malfunction (including position/angle misalignment of stereo cameras)

The buzzer sounds 1 short beep and the EyeSight warning light  flashes or illuminates. At the same time, the Pre-Collision Braking System OFF indicator light and the Lane Departure Warning OFF indicator light will illuminate. A message will also be displayed on the multi function display.

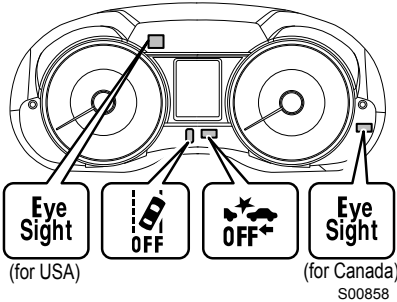

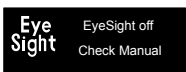
Display	Cause	Action
<p><Multi function display></p>  <p>S00859</p>	An EyeSight malfunction or position/angle misalignment of stereo cameras has occurred.	Inspection and adjustment is necessary. Contact your SUBARU dealer.

CAUTION

In the following conditions, the EyeSight warning light will illuminate. While the warning light is illuminated, the EyeSight system cannot be used.

- The stereo cameras are malfunctioning. Contact your SUBARU dealer for an inspection.
- The components related to the EyeSight system are malfunctioning (for example, the engine warning light illuminates). Immediately stop the vehicle in a safe location, and contact your SUBARU dealer for an inspection.

NOTE

- If the EyeSight warning light illuminated or flashed, stop the vehicle in a safe location, and after stopping the engine once, restart the engine.
- If the indicator continues illuminating or flashing even after the engine has been restarted, the EyeSight system has a malfunction. In this case, all EyeSight functions will be stopped. Normal driving will still be possible. However, contact a SUBARU dealer for an inspection.

Temporary stop

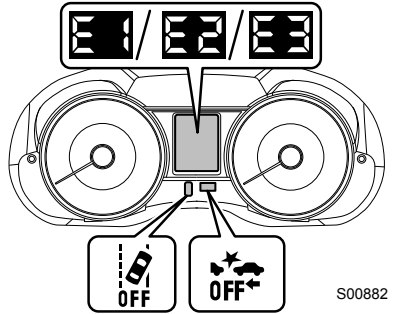

The buzzer will sound one short beep, and the Pre-Collision Braking System OFF indicator light and Lane Departure Warning OFF indicator light will illuminate at the same time. A symbol of “E1”, “E2” or “E3” is displayed on the meter display, and a pop-up screen is displayed on the multi function display. (When the main cruise control is off, they are not displayed.)

When the cause has been eliminated, temporary stop will be canceled and the EyeSight system will automatically restart.

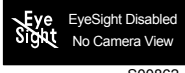

S00882

Display	Cause	Action
<p><Meter display></p>  <p>S00861</p> <p><Multi function display></p>  <p>S00862</p>	<p>It is difficult for the stereo cameras to detect objects in front</p> <ul style="list-style-type: none"> • The front windshield is dirty or fogged up • Poor weather conditions • Strong light from the front • Extremely hot or cold temperatures 	<ul style="list-style-type: none"> • Clean the front windshield. • In bad weather or if there is strong light from the front, the EyeSight system will restart once you have driven your vehicle for a period of time and the conditions affecting the system have improved. Also, as the “E1” screen will be displayed after the “E2” screen, once operation of the cameras is stable, the system will restart. In either case, it may take some time for the system to restart. If the system does not restart, even after the conditions have improved and a period of time has elapsed, contact your SUBARU dealer for an inspection.

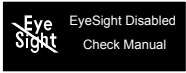
Displayed screen	Cause	Action
<p><Meter display></p>  <p>S00863</p> <p><Multi function display></p>  <p>S00864</p>	<p>In low or high temperatures</p>	<p>The system will restart once the temperature is within the operational range of the EyeSight system.</p> <p>If the system does not restart, even when the temperature inside the vehicle is normal, contact your SUBARU dealer for an inspection.</p>
<p><Meter display></p>  <p>S00865</p> <p><Multi function display></p>  <p>S00866</p>	<ul style="list-style-type: none"> • When the EyeSight system is starting • When the system has determined that the vehicle is extremely inclined • When the pre-collision secondary braking has operated 3 times after the engine was started • When the engine stops (except for the stop due to the start stop function). 	<p>The system will restart once the cause has been eliminated. At this time, it may take some time for the system to restart.</p> <p>If the system does not restart, even after the conditions have improved and a period of time has elapsed, contact your SUBARU dealer for an inspection.</p>







NOTE

When a symbol from “E1” to “E3” (EyeSight temporary stop indicators) is displayed, no EyeSight functions can be used except for Conventional Cruise Control.

Customizing functions

■ How to customize

The customizing function can be operated when the engine is running, the main cruise control is off (the  or  indicator is not displayed on the meter) and the select lever is in the **P** position.

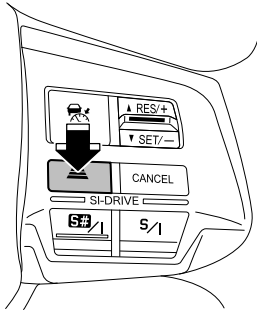

- (1) To turn the customization mode on, press the  (following distance setting) switch for approximately 2 seconds or more.
- (2) When the  (following distance setting) switch is pressed, the item of customization and the current setting are displayed on the meter display. Every time the switch is pressed, the item of customization will be changed.

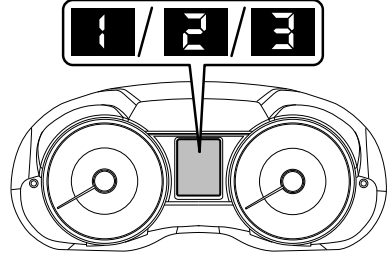

S00829



S00867

Display	Item	Setting	Default setting
	Warning volume	Max/Mid/Min	Mid
	Lead vehicle acquisition alert	Activate/Deactivate	Activate
	Lead Vehicle Start Alert	Activate/Deactivate	Activate

- (3) While pressing the RES/+ or SET/- switch, the setting is changed. (When the setting is changed, a beep sounds.)
- (4) The setting can be determined when the RES/+ or SET/- switch is released.

EX.: Warning volume setting

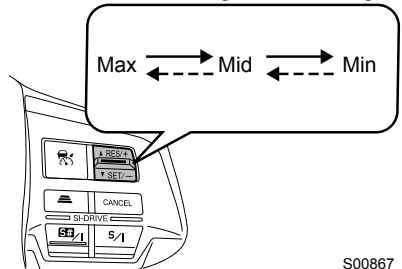

S00867

(5) To exit from the customizing mode, perform one of the following operations.

- Place the ignition switch to the ACC or LOCK (OFF) position.
- Turn the main cruise control on.
- Shift the select lever to any other position except for the **P** position.

● Warning volume setting

The warning volume can be set to Max/Mid/Min.

When the RES/+ or SET/- switch is pressed, the setting will change to the next and 3 short beeps will sound in the volume corresponding to the setting.

Setting	Display
Max	1 4.3
Mid	1 4.2
Min	1 4.1

S00869

● Lead vehicle acquisition alert setting

The lead vehicle acquisition alert function setting can be activated or deactivated.

When the RES/+ or SET/- switch is pressed, the setting will change to the next. When the setting is changed to be activated, a short beep will sound. When the setting is changed to be deactivated, no beeps will sound.

Setting	Display
Activate	2 ON
Deactivate	2 OF

S00870

● Lead Vehicle Start Alert setting

The Lead Vehicle Start Alert function setting can be activated or deactivated.

When the RES/+ or SET/- switch is pressed, the setting will change to the next. When the setting is changed to be activated, a two-tone beep will sound. When the setting is changed to be deactivated, this function is turned off and no beeps will sound.

Setting	Display
Activate	3 ON
Deactivate	3 OF

S00871



NOTE

Even when the engine is restarted after the ignition switch is placed in the LOCK (OFF) position, the setting will be restored to the previous status before the ignition switch is placed in the LOCK (OFF) position.

List of the pop-up screens on the multi function display

If an EyeSight warning or malfunction is detected, a pop-up screen will be displayed on the multi function display. Depending on the message, a buzzer will sound at the same time.

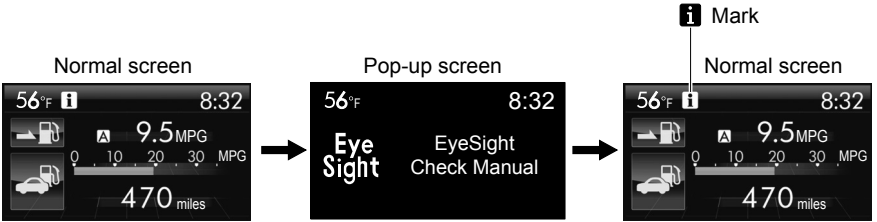

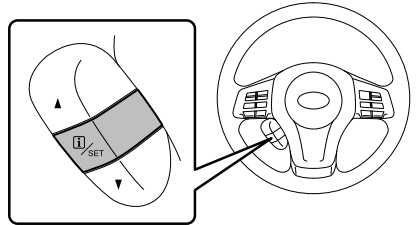

S00912

If a pop-up screen is displayed, refer to the pop-up screen list and take the appropriate action. Display screen 1 and display screen 2 will appear in order. While the **i** mark is illuminated, pull the **i** (information)/SET switch to indicate the pop-up screen again.





S00873

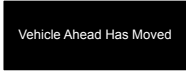
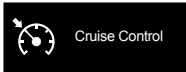

■ Screen list (warning indicator, etc.)

Item	Displayed screen	i mark	Action (Reference page)
The "brake more" warning	For Canada: MFD For USA: on the meter display	None	☆ Refer to page 42.
Pre-Collision Braking System	 S00874		☆ Refer to page 43.
Pre-Collision Throttle Management			☆ Refer to page 52.
Lane Departure Warning	For Canada: MFD For USA: on the meter display  S00875	None	☆ Refer to page 58.

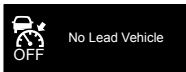
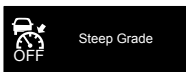
List of the pop-up screens on the multi function display



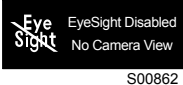









Item	Displayed screen	i mark	Action (Reference page)
Lane Sway Warning	For Canada: MFD For USA: on the meter display  S00876	None	☆ Refer to page 61.
Lead Vehicle Start Alert	 S00877	None	☆ Refer to page 64.
Conventional Cruise Control	 S00878	None	☆ Refer to page 68.
Automatic cancellation by the system	 S00879	None	☆ Refer to page 38.
	 S00880	None	☆ Refer to page 38.
	 S00881	None	☆ Refer to page 38.













■ Screen list (Malfunction, temporary stop, etc.)

Item	Displayed screen	i mark	Action (Reference page)
EyeSight System Malfunction*	 <p>EyeSight off Check Manual S00859</p>	Yes (yellow)	☆ Refer to page 76.
EyeSight system temporary stop	 <p>EyeSight Disabled No Camera View S00862</p>	None	☆ Refer to page 77.
	 <p>EyeSight Disabled Temp Range S00864</p>	None	☆ Refer to page 78.
	 <p>EyeSight Disabled Check Manual S00866</p>	None	☆ Refer to page 78.















*Depending on the location of malfunction,  will blink or illuminate.



Troubleshooting



	<p>Cruise control cannot be set.</p>
	<p>Did you remember to press the  (CRUISE) switch? If you have not pressed the  (CRUISE) switch, the  (Adaptive Cruise Control) indicator will not be shown.</p>
	<p>Is EyeSight operation temporarily stopped? When EyeSight is temporarily stopped, one of the EyeSight temporary stop indicators (“E1”, “E2” or “E3”) will be displayed on the data display. Set cruise control again after the reason for the temporary stop has been corrected.</p>
	<p>Is the [READY] indicator displayed? When Adaptive Cruise Control is being used Cruise control cannot be set when the [READY] indicator is not displayed. Set cruise control when the [READY] indicator is displayed.</p>
	<p>The [READY] indicator is not displayed.</p>
	<p>Have you selected Conventional Cruise Control? With Conventional Cruise Control,  (following distance setting) will not be displayed on the meter display.</p>
	<p>Are the requirements for setting cruise control met? In any of the following cases, the [READY] indicator will not be displayed.</p> <ul style="list-style-type: none"> • The brake pedal is depressed. • The vehicle speed is over 90 MPH (145 km/h). (When no vehicle in front has been detected, the speed is between approximately 25 MPH (40 km/h) and 90 MPH (145 km/h).) • The meter display indicates that the shift position indicator is in any position other than . (The select lever or paddle shift switches are manually operated.) • The driver’s seatbelt is unfastened. • Any door of the driver’s, front passenger’s and rear doors is opened. • The parking brake is applied (when the brake warning light is illuminated). • The vehicle is on a steep grade. • The steering wheel is turned significantly in either direction. • Vehicle Dynamics Control is off, or is turned off. • The X-mode is turned on. (The X-mode indicator illuminates.)



	<p>A vehicle (in front of your vehicle) is not detected, is detected later or detection is lost quickly.</p>
	<p>Is the vehicle in front stopped, moving slowly relative to your vehicle or moving extremely slowly? Detection of stopped vehicles, vehicle moving slowly relative to your vehicle, and vehicles moving extremely slowly may be difficult.</p>
	<p>Is the windshield dirty or fogged? If the windshield is dirty or fogged, it may not be possible to detect object or vehicles. Clean off the dirt or fog from the windshield, and then try using the system again.</p>
	<p>Is the vehicle in front far away? The maximum detection distance of EyeSight's stereo cameras is approximately 265 ft (80 m). Detection is not possible if the vehicle is farther away.</p>
	<p>Is the vehicle on a curve? The detection range is limited in the left and right directions to approximately a 25-degree arc from the vehicle centerline when the cameras are properly aimed.</p>
	<p>Is the vehicle on a road with repeated uphill and downhill grades (such as an overpass), or on a banked road? The detection range is limited in the up and down directions.</p>
	<p>Did the vehicle detected in front change? Detection may be delayed after the vehicle in front has changed.</p>
	<p>Have water, snow or other substances been kicked up by the vehicle in front as it drives? When water or snow have been kicked up, it may not be possible to detect the vehicle in front.</p>
	<p>Control is activated even though no vehicle in front is detected?</p>
	<p>Is there a vehicle in the neighboring lane? Depending on the road conditions, vehicles in neighboring lanes may be detected as well as a vehicle directly in front.</p>
	<p>Are you driving on or near a curve? When driving on a curve, braking control may be activated in response to guard rails, the angle of the steering wheel, or roadside structures.</p>
	<p>The Lead Vehicle Start Alert activates, even though there is no vehicle in front.</p>
	<p>Depending on surrounding objects, traffic environment and weather, the Lead Vehicle Start Alert may issue a warning in response to objects other than a vehicle that appear in front of your vehicle.</p>

Troubleshooting

	<p>EyeSight does not restart after a temporary stop.</p>
	<p>Is Vehicle Dynamics Control turned off? EyeSight cannot be activated when Vehicle Dynamics Control is off.</p>
	<p>Is the X-mode turned on? EyeSight cannot be activated when the X-mode is turned on.</p>
	<p>Are you driving in the rain with old wipers or is there an oily film on the windshield? Replace the wipers with new ones, or clean the oily film off the windshield.</p>
	<p>Is your vehicle subject to sunlight from the front (sunset or sunrise, etc.) or to bright headlights from oncoming vehicles at nighttime? In these cases, EyeSight may temporarily stop operating.</p>
	<p>The timing of the “brake more” warning is sometimes earlier and sometimes later than what seems to be normal operation.</p>
	<p>The “brake more” warning sounds when the system determines that more braking is necessary, based on conditions such as the distance from the vehicle in front and the difference in speed. As a result, timing may vary depending on how the brake of the vehicle in front is applied.</p>
	<p>Acceleration is sometimes slower and sometimes faster when the vehicle in front is no longer detected.</p>
	<p>Depending on the timing of when the detection of the vehicle in front is lost, EyeSight’s ability to react may be slower, causing the start of acceleration to feel delayed and braking time to feel longer than what seems to be normal operation.</p>
	<p>Which SI-DRIVE mode is selected? The acceleration varies due to the characteristics change of Adaptive Cruise Control depending on which mode is selected.</p>
	<p>Cruise control is canceled automatically.</p>
	<p>Did you perform one of the following operations?</p> <ul style="list-style-type: none"> • Manually depressing the brake pedal • Pressing the CANCEL switch for cruise control • Operating the paddle shift lever • Shifting the selector lever to the  position • Pressing the Vehicle Dynamics Control OFF switch (VDC OFF indicator illuminates.) • Pressing the X-mode switch (X mode indicator illuminates.)
	<p>Has the EyeSight system temporarily stopped?</p>

	<p>A noise occurs when automatic braking control activates.</p>
	<p>This is the sound of the automatic braking control operating.</p>

	<p>Braking control activates frequently when driving in heavy traffic.</p>
	<p>Unlike a human driving, the EyeSight system performs control based only on the actions of vehicles or objects in front. As a result, acceleration and deceleration may be more frequent. If it is difficult to maintain a consistent following distance, do not use Adaptive Cruise Control.</p>

	<p>A small jolt occurs when cruise control is used on a downhill grade.</p>
	<p>Downshift control occasionally occurs on downhill grades, and may produce a small jolt if it activates.</p>

MEMO



MSA5M1519A
B8192BE-B
Issued December 2013
Printed in USA 1/14
2015A



FUJI HEAVY INDUSTRIES LTD.
TOKYO, JAPAN

英語