

## 15.Rear Door Trim

### A: REMOVAL

**CAUTION:**

**Do not apply excessive force to clip. Otherwise the clip may be broken.**

1) Pull up inner remote cover toward you to remove upper hook. Pull down it to remove lower claw. Remove inner remote cover.

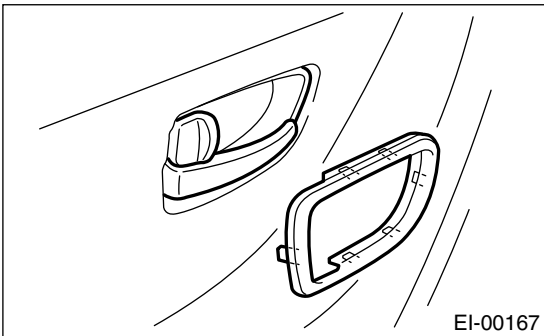

2) Remove two hook (A) of switch panel to remove power window sub switch and disconnect electrical connector.

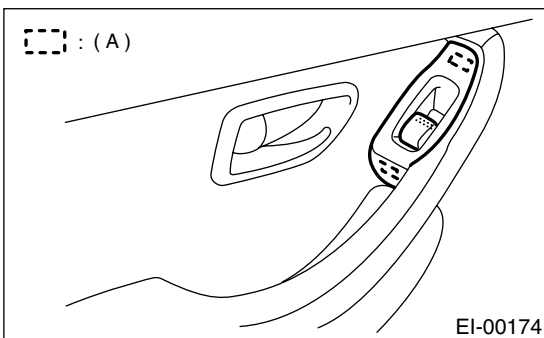

3) Remove two screws and clips.

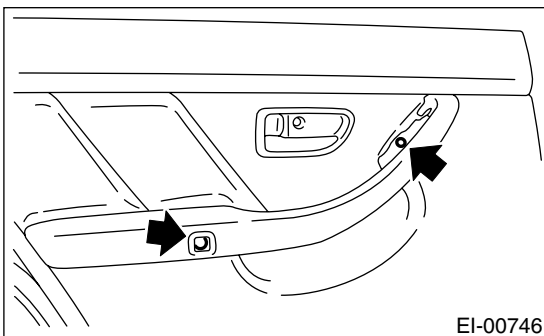

4) Remove seven clips (A) of trim panel using clip remover to remove trim panel.

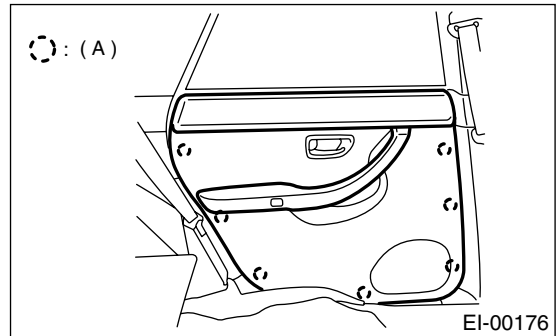

### B: INSTALLATION

Install in the reverse order of removal.