

2015

**Legacy/Outback EyeSight®  
Driver Assist Technology**



**Owner's Manual**



## Foreword

---

Congratulations on choosing a SUBARU vehicle equipped with EyeSight™. EyeSight incorporates the latest driver assistance features available from SUBARU, including such features as Adaptive Cruise Control, a Lead Vehicle Start Alert and a Lane Departure and Lane Sway Warning, all of which are designed to assist the driver in making decisions and increase driver comfort and convenience. Initially, the operation and use of the various EyeSight features may be unfamiliar to you. That is why we urge you to read this manual carefully before using EyeSight. We also recommend that you first take the time to test EyeSight in order to experience its features for yourself so that you can become familiar with their operation.

Please keep in mind that it is the responsibility of drivers to operate their vehicles safely at all times. Drivers should always remain alert and should never become complacent while operating their vehicles because of the presence of EyeSight. EyeSight is never a substitute for active driver involvement and it may not operate optimally under all driving conditions.

This booklet is a supplement to the Owner's Manual for your SUBARU vehicle and contains a detailed description of EyeSight. It should be read in conjunction with your Owner's Manual so that you will gain a thorough understanding of the proper operation of your vehicle.

The information, specifications and illustrations found in this booklet are those in effect at the time of printing. FUJI HEAVY INDUSTRIES LTD. reserves the right to change specifications and designs at any time without prior notice and without incurring any obligation to make the same or similar changes on vehicles previously sold.

Please keep this booklet together with your Owner's Manual and leave it in the vehicle at the time of resale. The next owner will need the information it contains.

**FUJI HEAVY INDUSTRIES LTD., TOKYO, JAPAN**

 **SUBARU** is a registered trademark of FUJI HEAVY INDUSTRIES LTD.

© Copyright 2014 FUJI HEAVY INDUSTRIES LTD.



# EyeSight

|   |    |
|---|----|
| About EyeSight                          | 2  |
| Pre-Collision Braking System            | 20 |
| Adaptive Cruise Control                 | 32 |
| Pre-Collision Throttle Management       | 54 |
| Lane Departure Warning                  | 60 |
| Lane Sway Warning                       | 63 |
| Lead Vehicle Start Alert                | 66 |
| Conventional Cruise Control             | 67 |
| List of buzzer sounds                   | 77 |
| EyeSight malfunction and temporary stop | 78 |
| Customizing functions                   | 81 |
| Message screen list                     | 83 |
| Troubleshooting                         | 85 |

# About EyeSight

## EyeSight

EyeSight is a driving support system that uses a range of functions to assist the driver in making decisions in order to provide for more safe and comfortable driving and to reduce driver fatigue. Making use of images created by stereo cameras specially designed by SUBARU, EyeSight detects the vehicle in front, obstacles, traffic lanes and other items.



### WARNING

**Drivers are responsible for driving safely. Always comply with all traffic rules and regulations regardless of the fact that your vehicle is equipped with EyeSight. Always maintain a safe following distance behind the vehicle in front of you, pay attention to your surroundings and the driving conditions, operate the brake pedal and take other action as necessary in order to maintain a safe following distance.**

**Never attempt to drive relying on EyeSight alone.**

**EyeSight is intended to assist the driver in making decisions in order to reduce the chance of accidents or damage and lessen the burden on the driver.**

**When a warning is activated, pay attention to what is in front of you and to your surroundings, operate the brake pedal and take other action as necessary.**

**This system is not designed to support driving in poor visibility or in extreme weather conditions, or to protect against careless driving when the driver is not paying complete attention to the road ahead. It also cannot prevent collisions from occurring in all driving conditions.**

**There are limits to the EyeSight recognition performance and control performance. Be sure to read the instructions for each function before using the system, and always use it properly. Improper use may lead to failure of control performance, which could cause an accident.**

Refer to the following pages for each function:

- For the Pre-Collision Braking System, refer to page 20.
- For Adaptive Cruise Control, refer to page 32.
- For Pre-Collision Throttle Management, refer to page 54.
- For Conventional Cruise Control, refer to page 67.

**The EyeSight system in your vehicle is designed for use in countries in which traffic operates on the right-hand side of the road. EyeSight for LHD vehicles such as yours is not designed for use in countries in which vehicles are driven on the left-hand side of the road.**

- The system may not operate correctly under the conditions listed below. When these conditions occur, turn off the Pre-Collision Braking System. Also, do not use Adaptive Cruise Control.
  - The tire pressure is not correct.\*1
  - The temporary spare tire is installed on any wheel.\*1

- Tires that are worn or have large variations in wear conditions are installed.\*1
- Tires other than those of the designated size are installed.\*1
- Flat tires have been fixed temporarily with a tire repair kit.
- The suspension has been modified (including a genuine SUBARU suspension that has been modified).
- Any object that disturbs the stereo cameras' view is installed on the vehicle.
- The headlights are dirty or they have snow and ice or dirt on them. (Objects are not correctly illuminated and are difficult to detect.)
- The optical axes are not aligned correctly. (Objects are not correctly illuminated and are difficult to detect.)
- The lights including headlights and fog lamps have been modified.
- Vehicle operation has become compromised due to an accident or malfunction.
- The brake system warning light is illuminated in red.
- A heavy cargo is loaded onto or inside the vehicle.
- The maximum number of occupants is exceeded.
- There is something wrong with the combination meter; such as when the lights do not illuminate, the beeps do not sound, the display is different from when it is normal, etc.\*2

\*1: The wheels and tires have functions that are critically important. Be sure to use the correct ones. For details, refer to the Owner's Manual for your vehicle.

\*2: For details about the combination meter, refer to the Owner's Manual for your vehicle.

 **CAUTION**

- The characteristics of the stereo cameras are similar to those of human eyes. For this reason, conditions that make it difficult for the driver to see in the forward direction have the same effect on the stereo cameras and make it difficult for the system to detect vehicles, obstacles and traffic lanes.
- Detection by the EyeSight system is limited to objects that are within the range of the stereo cameras' field of vision. Also, after an object enters the range of the cameras' field of vision, it may take some time for the system to detect it as a controllable target and warn the driver.

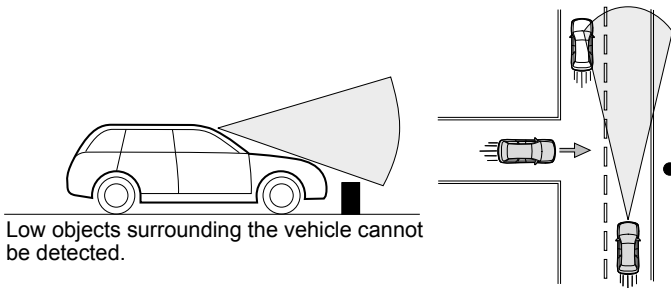

S01263

- Under the conditions listed below, it will become more difficult for the system to detect the vehicle in front, motorcycles, bicycles, pedestrians and obstacles on the road, and lane markers. Also, EyeSight may temporarily stop operating. However, the temporary stop will be canceled once these conditions have improved and the vehicle is driven for a short period of time.
  - Bad weather (for example heavy rain, a blizzard or thick fog). In particular, the system is more likely to temporarily stop operating when there is an oil film adhering to the windshield, a glass coating has been applied or old wipers are used.)
  - When affected by strong light from the front (sunlight or headlight beams of oncoming traffic, etc.)
  - When the front windshield washer is being used.
  - The windshield has become fogged, or snow, dirt, dust or frost has adhered to it, reducing the stereo cameras' field of view.
  - The vehicle is tilted at an extreme angle due to loaded cargo or other factors.
  - When visibility is poor due to sand, smoke or water vapor in the air, or when the vehicle in front or oncoming traffic causes water, snow, dirt or other substances to obscure the view
  - When the stereo cameras' field of view is obstructed (for example by a canoe on the roof of the vehicle)

- When passing through the entrance or exit of a tunnel
- When the rear aspect of the vehicle in front is low, small or irregular (for example a low bed trailer, etc.)
- When there is a fence, a wall or a shutter, etc. with a uniform pattern (a striped pattern, brick, etc.) or with no pattern in front
- When there is a wall or door made of glass or a mirror in front
- When driving at night or in a tunnel when there is a vehicle in front that does not have its taillights on
- When passing a banner or flag, low branches on a tree or thick/tall vegetation
- On steep uphill or downhill grades
- When the stereo cameras are obstructed by a hand, etc. (If even one of the cameras is obstructed, the system does not operate properly.)
- When it is completely dark and no objects are detected
- When the area around the vehicle has a uniform color (such as when completely covered in snow, etc.)
- When the stereo camera lenses are dirty due to fingerprints, etc.
- When accurate detection is not possible due to reflections in the front windshield
- When the stereo cameras have become misaligned due to a strong impact
- Under the conditions listed below, EyeSight may temporarily stop operating. If this occurs, EyeSight will resume operating when the conditions improve.
  - The temperature inside the vehicle is high, such as after the vehicle was left in bright sunshine, or the temperature inside the vehicle is low, such as after the vehicle was left in an extremely cold environment.
  - Immediately after the engine starts
- When there is a malfunction in the EyeSight system, turn off the Pre-Collision Braking System (⇒ refer to page 30) and the Lane Departure Warning (⇒ refer to page 62), and stop using the Adaptive Cruise Control. Contact a SUBARU dealer and have the system inspected.





**NOTE**

- EyeSight records and stores the following data when the Pre-Collision Braking System is operated. It does not record conversations or other audio data.
  - Stereo camera image data
  - Distance from the vehicle in front
  - Vehicle speed
  - Steering wheel turning angle
  - Lateral movement with regard to the direction of travel
  - Accelerator pedal operation status
  - Brake pedal operation status
  - Select lever position
  - Odometer reading
  - Data related to ABS, Vehicle Dynamics Control and Traction Control Function

SUBARU and third parties contracted by SUBARU may acquire and use the recorded data for the purpose of vehicle research and development. SUBARU and third parties contracted by SUBARU will not disclose or provide the acquired data to any other third party except under the following conditions.

- The vehicle owner has given his/her consent.
- The disclosure/provision is based on a court order or other legally enforceable request.
- Data that has been modified so that the user and vehicle cannot be identified is provided to a research institution for statistical processing or similar purposes.

## Handling of the Stereo Cameras

The stereo cameras are installed at the positions of the front map lights.

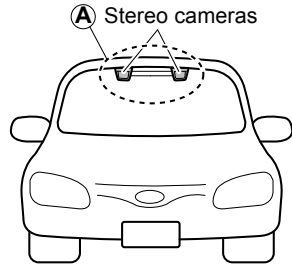

S01107

### CAUTION

- A function is included that will automatically detect that the fronts of the stereo cameras are dirty. However it is not 100% effective. Under certain conditions, this function may fail to detect that the fronts of the stereo cameras have become dirty. In addition, this function may not detect that there is snow or ice on the windshield close to the stereo cameras. In such conditions, be sure to keep the windshield clean at all times (indicated by ). Otherwise the system may not operate correctly. When this function detects that the fronts of the stereo cameras are dirty, no EyeSight functions are activated except for Conventional Cruise Control.
- The stereo camera is a precision component. Always observe the following precautions especially when handling lenses.
  - Never touch the stereo camera lenses, and do not attempt to wipe or clean the lenses. Doing so could cause lens damage or contamination and lead to improper system performance. If you ever touch a lens for any reason, be sure to contact a SUBARU dealer.

Continued on next page ⇒

⇒ Continued from previous page

- When cleaning the front windshield, cover the front of the camera casing with paper that does not collect dust, such as copy paper. Affix the paper to prevent glass cleaner from getting on the camera lenses. At this point, make sure that the tape's adhesive surface does not come in contact with the windshield or the lens. Be sure to remove the paper after cleaning.
- When having the inside of windshield cleaned at a service station, etc., be sure to request that the attendant covers the camera covers before washing the vehicle.

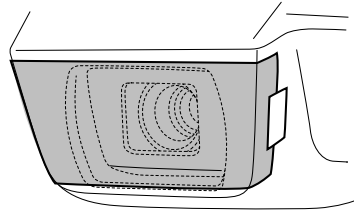

S01097

- Do not subject the stereo cameras to a strong impact.
- Do not remove or disassemble the stereo cameras.
- Do not change the positions where the stereo cameras are installed or modify any of the surrounding structures.
- Do not install an interior rearview mirror other than a genuine SUBARU rearview mirror (such as a wide-type mirror) and the sun visor. Also, use the rearview mirror so that it does not obstruct the stereo cameras. Failure to do so may affect the stereo cameras' field of vision and could prevent the EyeSight system from functioning properly.

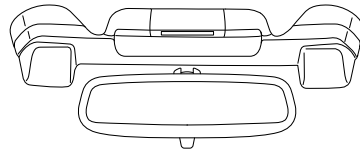
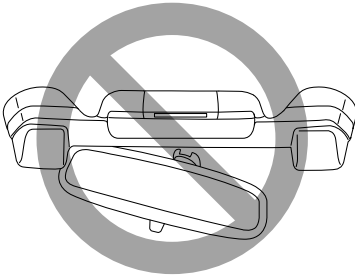

S00509

- Do not install any accessories other than the ones designated by SUBARU on the prohibited areas shown in the illustrations (grey zones). Even if some accessories are installed on the outside of the prohibited areas, abnormal operation of EyeSight may occur due to the reflection of the light or any objects. In this situation, move the accessories. For details, contact a SUBARU dealer.

<Side view>

<Front view>

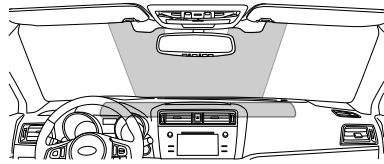
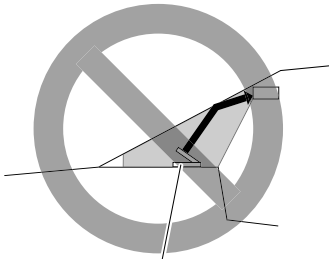

Monitor or other accessories

S01108

- Do not place any objects on top of the instrument panel. The stereo cameras may not be able to detect objects accurately and the EyeSight system may not function properly due to reflections in the front windshield. For details, contact a SUBARU dealer.
- If the top of the instrument panel is polished with chemicals or other substances, the stereo cameras may not be able to detect objects accurately and the EyeSight system may not operate properly due to reflections in the front windshield.
- Do not install any wiper blades other than genuine SUBARU wiper blades. Doing so may affect the stereo cameras' field of vision and could prevent the EyeSight system from functioning properly.
- Replace damaged wiper blades as soon as possible. The stereo cameras may not be able to detect objects accurately and the EyeSight system may not function properly due to liquid remaining on the windshield.

- Do not install any accessories on the front side such as on the hood or the grille. It may affect the camera view and the system may not operate correctly.
- Make sure that the cargo loaded on the roof does not obstruct or interfere in the stereo cameras' field of view. Obstructing the stereo cameras' view may impair the system operation. For details, contact a SUBARU dealer.

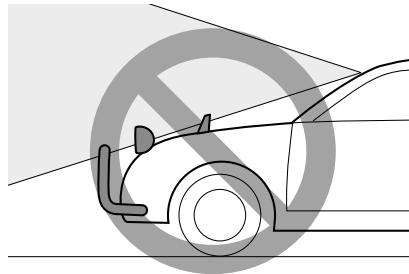

S01098

Continued on next page ⇒

⇒ Continued from previous page

- Keep the windshield (outside and inside) clean at all times. When the windshield has become fogged, or it has a dirt or an oil film on it, the stereo camera may not detect objects accurately and the EyeSight system may not operate correctly.
- Do not place any stickers or accessories on the windshield (outside or inside). If you have to do so (for example, legally required or electronic toll tag), avoid the area directly in front of the camera. Doing so may adversely affect the field of vision of the stereo camera and can cause improper operation of the system. For details, contact a SUBARU dealer.
- Do not use any glass coating agents or similar substances on the windshield. Doing so may prevent the system from operating correctly.
- Do not install a film on the front windshield. The system may not operate correctly.
- If there are scratches or cracks on the front windshield, contact a SUBARU dealer.
- To have the front windshield replaced or repaired, contact a SUBARU dealer. Do not install a front windshield other than a genuine SUBARU front windshield. The stereo cameras may not be able to detect objects accurately and the EyeSight system may not operate properly.

## EyeSight Functions

EyeSight includes the following functions.

### ■ Pre-Collision Braking System

This function uses a following distance warning feature to warn the driver to take evasive action when there is the possibility of a collision with a vehicle or obstacle in front of the driver's vehicle. If the driver still does not take evasive action, the brakes are quickly applied automatically just before the collision in order to reduce the collision damage or, if possible, prevent the collision.

⇒ Refer to page 20.

### ■ Adaptive Cruise Control

This function maintains the set vehicle speed and when there is a vehicle in front in the same traffic lane, it tracks the speed of the vehicle in front up to the maximum of the set vehicle speed.

⇒ Refer to page 32.

### ■ Pre-Collision Throttle Management

This function reduces accidental forward movement caused by the selector lever being placed in the wrong position or the accelerator pedal being accidentally depressed, or depressed too strongly.

⇒ Refer to page 54.

### ■ Lane Departure Warning

This function warns the driver when the vehicle is about to depart the traffic lane during driving.

⇒ Refer to page 60.

### ■ Lane Sway Warning

This system detects vehicle drifting caused by driver fatigue, failure to concentrate on the road, inattention, strong crosswinds or other factors, and warns the driver.

⇒ Refer to page 63.

### ■ Lead Vehicle Start Alert

This function notifies the driver when the vehicle in front has started moving but the driver's vehicle has not.

⇒ Refer to page 66.

## ■ Conventional Cruise Control

In this mode, the system maintains a constant vehicle speed. Tracking of the vehicle in front does not occur. This function can be used even when the stereo cameras have temporarily stopped operating. (⇒ Refer to page 79.) (This function is used by switching from Adaptive Cruise Control to Conventional Cruise Control.)

⇒ Refer to page 67.



### **NOTE**

EyeSight does not operate when the engine is not running.

# Instrument panel display layout

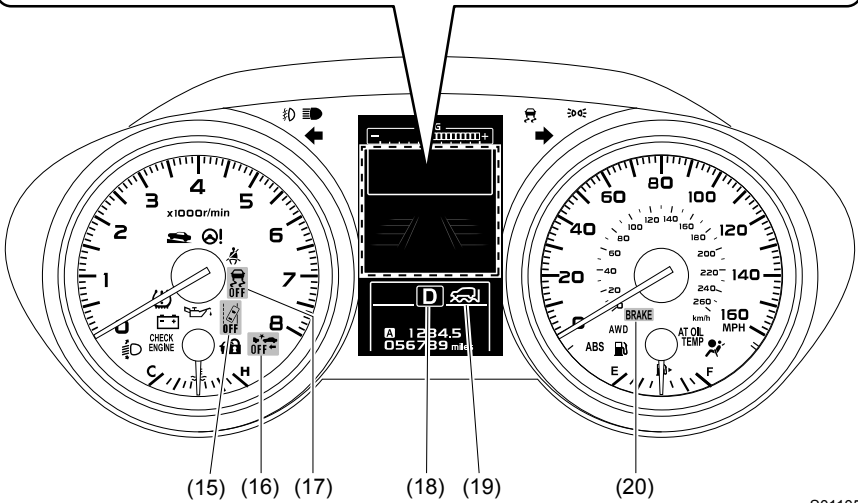
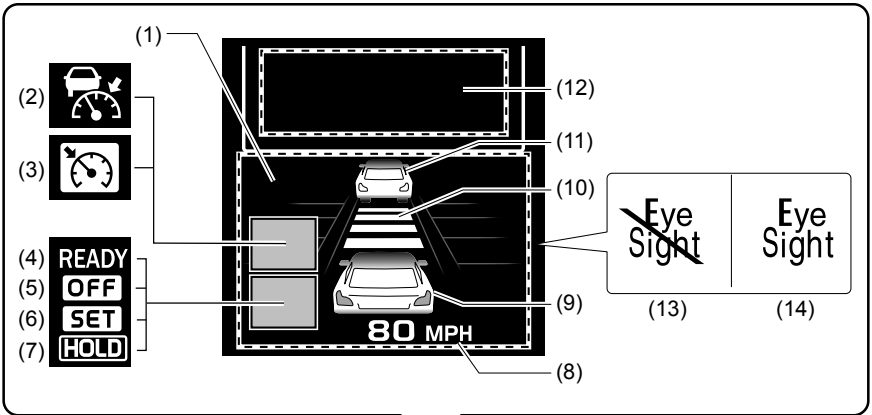

S01105

\* Display units can be changed in Screen Settings. For details, refer to the Owner's Manual for your vehicle.

- |   |   |
|---|---|
| (1) EyeSight display area                 | (11) Lead vehicle indicator                           |
| (2) Adaptive Cruise Control indicator     | (12) The pop-up screen area                           |
| (3) Conventional Cruise Control indicator | (13) EyeSight temporary stop indicator (White)        |
| (4) READY indicator                       | (14) EyeSight warning indicator (Yellow)              |
| (5) OFF indicator                         | (15) Lane Departure Warning OFF indicator light       |
| (6) SET indicator                         | (16) Pre-Collision Braking System OFF indicator light |
| (7) HOLD indicator                        | (17) VDC OFF indicator light                          |
| (8) Set vehicle speed display             | (18) Selector indicator/shift position indicator      |
| (9) Your vehicle indicator                | (19) X-mode indicator                                 |
| (10) Following distance setting indicator | (20) Brake system warning light                       |



## ■ CRUISE indicator

- This indicator illuminates when the main cruise control is on.



: Adaptive Cruise Control (Adaptive Cruise Control indicator)



: Conventional Cruise Control (Conventional Cruise Control indicator)

⇒ Refer to pages 38 and 67.

- When Adaptive Cruise Control is set and the vehicle detects a car in front, this indicator (white) turns green.

⇒ Refer to page 40.

## ■ SET indicator

**SET** illuminates when cruise control\* is set.

⇒ Refer to pages 39 and 70.

\* Adaptive Cruise Control and Conventional Cruise Control

## ■ READY indicator

**READY** illuminates when cruise control\* can be set.

⇒ Refer to pages 38 and 69.

\* Adaptive Cruise Control and Conventional Cruise Control

## ■ HOLD indicator

**HOLD** illuminates when the stay-stopped function is operated while Adaptive Cruise Control is on.

⇒ Refer to page 46.

## ■ OFF indicator

**OFF** illuminates when cruise control\* has been automatically canceled.

⇒ Refer to pages 49 and 74.

\* Adaptive Cruise Control and Conventional Cruise Control



## ■ Lead vehicle indicator

- When Adaptive Cruise Control is set or when the vehicle is stopped, this indicator illuminates when a vehicle in front has been detected.

⇒ Refer to page 40.

- This indicator illuminates in the following cases.
  - The Lead Vehicle Start Alert is active.
  - The Pre-Collision Braking System is active.
  - The “brake more” warning is active.
  - Pre-Collision Throttle Management is active.

## ■ Following distance setting indicator

Indicates the following distance setting that was set with the  /  (Following distance setting) switch.

⇒ Refer to page 45.

## ■ Set vehicle speed display

Displays the set vehicle speed.

⇒ Refer to pages 38 and 68.

## ■ Your vehicle indicator

When the brake pedal is depressed or the brake control function is active, the brake light on the indicator illuminates in red.

## ■ Selector indicator/shift position indicator

- This indicator illuminates and shows which position the selector lever or the gear is in.

## ■ EyeSight warning indicator (yellow)

- This indicator illuminates or flashes when a malfunction occurs in the EyeSight system.
- When it is illuminated or flashing, none of the EyeSight functions can be used (including Adaptive Cruise Control and the Pre-Collision Braking System, etc.).

⇒ Refer to page 78.

## ■ EyeSight temporary stop indicator (white)

- This indicator illuminates when the EyeSight system is temporarily stopped.
- When the ignition switch is placed in the ON position, it will illuminate if the  (CRUISE) switch is set to ON within approximately 7 seconds of the engine starting. It turns off when approximately 7 seconds have elapsed since the engine started.
- When it is illuminated, none of the EyeSight functions can be used except for Conventional Cruise Control.

⇒ Refer to page 79.

## ■ Lane Departure Warning OFF indicator light

- This indicator illuminates when the Lane Departure Warning and Lane Sway Warning are off.
- It also illuminates when the ignition switch is turned to the ON position, and then approximately 7 seconds after the engine starts, the Lane Departure Warning will be turned on. The default setting for the Lane Departure Warning when the vehicle is restarted is "ON".

⇒ Refer to page 62.

## ■ Pre-Collision Braking System OFF indicator light

- Illuminates when the Pre-Collision Braking System and Pre-Collision Throttle Management are off.
- It also illuminates when the ignition switch is turned to the ON position, and then turns off approximately 7 seconds after the engine starts.

⇒ Refer to page 30.







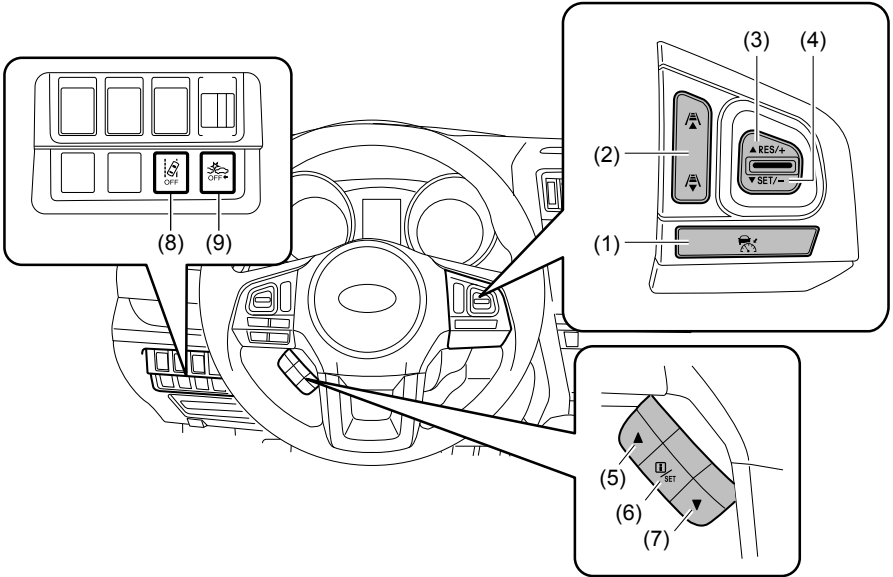

## ■ VDC OFF indicator light

- It illuminates when the engine starts and turns off within approximately 2 seconds.
- It illuminates when the VDC OFF switch is pressed and VDC is off. Refer to the Owner's Manual for your vehicle.



## Switch layout



S01106

- |     |   |     |   |
|-----|---|-----|---|
| (1) |  (CRUISE) switch   | (6) |  (Info)/SET switch                           |
| (2) |  /  (Following distance setting) switch | (7) |  switch                                      |
| (3) | RES/+ switch  | (8) |  (Lane Departure Warning OFF) switch        |
| (4) | SET/- switch  | (9) |  (Pre-Collision Braking System OFF) switch |
| (5) |  switch  |     |   |

## ■ (CRUISE) switch

- Switches cruise control\* on/off.
- When this switch is pressed “” or “” appears on the EyeSight display area in the multi information display. This indicates that the main cruise control is turned on.

⇒ Refer to pages 38 and 68.

- Can be used to cancel the cruise control.

⇒ Refer to pages 48 and 73.

\* Adaptive Cruise Control and Conventional Cruise Control

## ■ RES/SET switch

### ● SET/-

- Can be used to set cruise control\*.
- Can be used to reduce the set vehicle speed (when cruise control\* is currently set).

⇒ Refer to pages 39 and 43 (for Adaptive Cruise Control).

⇒ Refer to pages 70 and 72 (for Conventional Cruise Control).

### ● RES/+

- After cruise control\* is canceled, this switch can be used to resume the cruise control function at the vehicle speed that was previously set.
- Can be used to increase set vehicle speed (when cruise control\* is currently set).

⇒ Refer to pages 42 and 51 (for Adaptive Cruise Control).

⇒ Refer to pages 71 and 76 (for Conventional Cruise Control).

\* Adaptive Cruise Control and Conventional Cruise Control

## ■ / (Following distance setting) switch

- Can be used to switch the set following distance in 4 stages: (only when Adaptive Cruise Control is on).

⇒ Refer to page 45.

- When the  (CRUISE) switch is on, press and hold this switch for approximately 2 seconds or longer to select Adaptive Cruise Control or Conventional Cruise Control.

## ■ switch/ switch

These are used in the following situations.

- When switching the screen displayed on the multi information display.
- When changing the Warning Volume settings, etc.

⇒ Refer to page 81.

## ■ (Info)/SET switch

This is used in the following situations.

- When displaying the message that appeared in the pop-up screen area again.  
⇒ Refer to page 83.
- When changing the Warning Volume settings, etc.  
⇒ Refer to page 81.

## ■ (Pre-Collision Braking System OFF) switch

Press and hold this switch for approximately 2 seconds or longer to turn off the Pre-Collision Braking System and Pre-Collision Throttle Management.

When these functions are off, the Pre-Collision Braking System OFF indicator light on the instrument panel illuminates.

Press and hold the switch again to turn on the Pre-Collision Braking System and Pre-Collision Throttle Management. This turns off the Pre-Collision Braking System OFF indicator light.

⇒ Refer to page 30.

## ■ (Lane Departure Warning OFF) switch

Press and hold this switch for approximately 2 seconds or longer to turn off the Lane Departure Warning and Lane Sway Warning functions.

When these functions are off, the Lane Departure Warning OFF indicator light on the instrument panel illuminates.

Press and hold the switch again to turn on the Lane Departure Warning and Lane Sway Warning functions. This turns off the Lane Departure Warning OFF indicator light.

⇒ Refer to page 62.

# Pre-Collision Braking System

When there is the risk of a rear-end collision with an obstacle in front, the EyeSight system helps to minimize or prevent a collision by warning the driver. If the driver still does not take evasive action to avoid a collision, the brakes can be automatically applied just before the collision in order to reduce impact damage, or if possible, prevent the collision. If the driver takes evasive action to avoid a collision, Pre-Collision Brake Assist will operate in order to help the driver to prevent the collision.

This system can be effective not only with direct rear-end collisions, but also with offset rear-end collisions. This function can be activated when the select lever is in the **D**, **M** or **N** positions.



## WARNING

- Never use the Pre-Collision Braking System and Pre-Collision Brake Assist to stop your car or avoid a collision under ordinary conditions. These functions cannot prevent collisions under all conditions. If the driver relies only on the Pre-Collision Braking System for Brake operation, collisions may occur.
- When a warning is activated, pay attention to the front of the vehicle and its surroundings, and operate the brake pedal and/or take other actions if necessary.
- The EyeSight Pre-Collision Braking System is primarily designed to prevent rear-end collisions with other vehicles when possible and to minimize damage and injuries in the event of a collision. In addition to other vehicles, things such as motorbikes, bicycles and pedestrians can also be treated as obstacles. However, there may be cases when detection is not possible depending on a variety of conditions<sup>2</sup>. For example, when a vehicle is viewed from the side, oncoming vehicle, vehicles approaching in reverse, small animals or children, or walls or doors are not likely to be detected.
- The Pre-Collision Braking System will operate at the point when it determines that a collision cannot be avoided and is designed to apply strong braking force just before a collision. The result of this varies depending on a variety of conditions<sup>2</sup>. Because of this, performance of this function will not always be the same.
- When the Pre-Collision Braking System is activated, it will continue to operate even if the accelerator pedal is partially depressed. However, it will be canceled if the accelerator pedal is deeply depressed.
- If the driver depresses the brake pedal or turns the steering wheel, the system may determine that this constitutes evasive action by the driver, and the automatic braking control may not activate in order to allow the driver full control.
- When the difference in speed with the obstacle in front is the following figure<sup>1</sup> or more, it may not be possible to avoid a collision. Even if the speed difference is the following figure<sup>1</sup> or less, in cases such as when another vehicle cuts in front of you, or in other cases depending on visibility, the condition of road surface and other factors<sup>2</sup>, the function may be unable to stop the vehicle or may not activate. Pre-Collision Brake Assist also may not activate depending on the conditions<sup>2</sup> listed below.

\*1: For vehicles: approximately 30 MPH (50 km/h),

For pedestrians: approximately 21 MPH (35 km/h)

\*2: Conditions

- Distance to obstacle in front of you, speed difference, proximity conditions, lateral displacement (the amount of offset)
- Vehicle conditions (amount of load, number of occupants, etc.)
- Road conditions (grade, slipperiness, shape, bumps, etc.)
- When visibility ahead is poor (rain, snow, fog or smoke, etc.)

- When the detected object is something other than a vehicle, motorcycle, bicycle or pedestrian
  - A domestic animal or other animal (a dog or deer, etc.)
  - A guardrail, telephone pole, tree, fence or wall, etc.
- Even if the obstacle is a motorcycle, bicycle or pedestrian, depending on the brightness of the surroundings as well as the relative movement, and aspect or angle of the object, there may be cases when the system cannot detect it.
- When the system determines that operation by the driver (based on accelerator pedal operation, braking, steering wheel angle, etc.) is intended as evasive action
- Vehicle maintenance status (brake systems, tire wear, tire pressure, whether a temporary spare tire is being used, etc.)
- When towing a trailer or another vehicle, etc.
- When the brakes are cold due to outside temperature being low or just after starting the engine.
- When the brakes are overheated on downhill grades (braking effectiveness is reduced)
- When driving in rain or after washing the vehicle (the brakes are wet and braking effectiveness is reduced)
- Recognition conditions of the stereo cameras  
In particular, the function may be unable to stop the vehicle or may not activate in the following cases.
  - Bad weather (for example heavy rain, a blizzard or thick fog)
  - When visibility is poor due to sand, smoke or water vapor in the air or when the vehicle in front or oncoming traffic causes water, snow, dirt, dust or other substances to obscure the view through the windshield
  - When driving at night or in a tunnel without the headlights on
  - When driving at night or in a tunnel when there is a vehicle in front that does not have its taillights on
  - When approaching a motorcycle, bicycle or pedestrian at night
  - When ambient light is poor in the evening or early morning
  - When a vehicle, motorcycle, bicycle or pedestrian is outside the area illuminated by the headlights
  - When affected by strong light from the front (for example, sunlight at dawn, sunset or headlight beams, etc.)
  - When there is snow, frost, dirt or dust on the windshield or it is clouded
  - When fluid has not been fully wiped off the windshield during or after washer use
  - When the target cannot be correctly recognized because the stereo cameras' view is obstructed by water droplets from rain or the window washer, or by the wiper blades.
  - When the stereo cameras' field of view is obstructed (for example by a canoe on the roof of the vehicle)

Continued on next page ⇒



⇒ Continued from previous page

- When the rear aspect of the vehicle in front is low, small or irregular (the system may recognize another part of the vehicle as its rear and will determine operation from that)

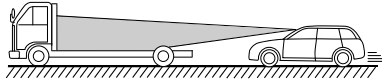

S00654

- When there is an empty truck or trailer with no rear and/or side panels on the cargo bed
  - With vehicles that have cargo protruding from their back ends
  - With non-standard shaped vehicles (vehicle transporters or vehicles with a sidecar fitted, etc.)
  - When the height of the vehicle is low, etc.
- When there is a wall, etc. in front of a stopped vehicle
  - When there is another object near the vehicle
  - When a vehicle, etc. has its side facing you.
  - With vehicles that are backing up or with oncoming vehicles, etc.
  - When the size and height of an obstacle is smaller than the limitations of the stereo cameras' recognition capability
    - With small animals or children, etc.
    - With pedestrians who are sitting or lying down

- When the detected object is a fence or wall, etc. with a uniform pattern (a striped pattern or brick pattern, etc.)
- When there is a wall or door made of glass or a mirror in front
- When the vehicle in front suddenly swerves, accelerates, or decelerates.
- When a vehicle, motorcycle, bicycle or pedestrian suddenly cuts in from the side or suddenly runs in front of you.

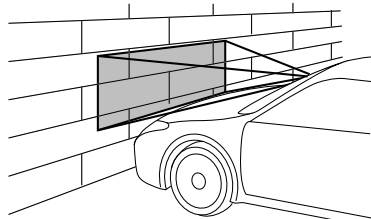

S00653

- When you suddenly change lanes and your vehicle is immediately behind an obstacle
- When there is a vehicle, motorcycle, bicycle or pedestrian in a location close to your vehicle's bumper
- When the speed difference between your vehicle and an obstacle is 4 MPH (5 km/h) or less (As braking is performed once the obstacle is in close proximity to your vehicle, depending on the shape and size of the obstacle, there may be some cases when the obstacle is outside the range of the cameras' field of vision.)
- When driving on sharp curves, steep uphill grades or steep downhill grades
- When driving on a bumpy or unpaved road

- When there are changes in brightness, such as at a tunnel entrance or exit
  - Do not test Pre-Collision Braking System on its own. It may operate improperly and cause an accident.
  - The system may not operate correctly under the conditions listed below. When these conditions occur, turn off the Pre-Collision Braking System.
    - The tire pressure is not correct.<sup>\*1</sup>
    - The temporary spare tire is installed on any wheel.<sup>\*1</sup>
    - Tires that are worn or have large variations in wear conditions are installed.<sup>1</sup>
    - Tires other than those of the designated size are installed.<sup>\*1</sup>
    - Flat tires have been fixed temporarily with a tire repair kit.
    - The suspension has been modified (including a genuine SUBARU suspension that has been modified).
    - Any object that disturbs the stereo cameras' view is installed on the vehicle.
    - The headlights are dirty or they have snow and ice or dirt on them. (Objects are not correctly illuminated and are difficult to detect.)
    - The optical axes are not aligned correctly. (Objects are not correctly illuminated and are difficult to detect.)
    - The lights including headlights and fog lamps have been modified.
    - Vehicle operation has become compromised due to an accident or malfunction.
    - The brake system warning light is illuminated in red.
    - A heavy cargo is loaded onto or inside the vehicle.
    - The maximum number of occupants is exceeded.
    - There is something wrong with the combination meter; such as when the lights do not illuminate, the beeps do not sound, the display is different from when it is normal, etc.<sup>\*2</sup>
- \*1: The wheels and tires have functions that are critically important. Be sure to use the correct ones. For details, refer to the Owner's Manual for your vehicle.
- \*2: For details about the combination meter, refer to the Owner's Manual for your vehicle.

**CAUTION**

- In the following situations, turn off the Pre-Collision Braking System. Otherwise the Pre-Collision Braking System may activate unexpectedly.
  - When the vehicle is being towed
  - When loading the vehicle onto a carrier
  - When a chassis dynamometer, free-rollers or similar equipment is used
  - When a mechanic lifts up the vehicle, starts the engine and spins the wheels freely
  - When passing hanging banners, flags or branches, or when thick/tall vegetation is contacting the vehicle
  - When using a drive-through car wash

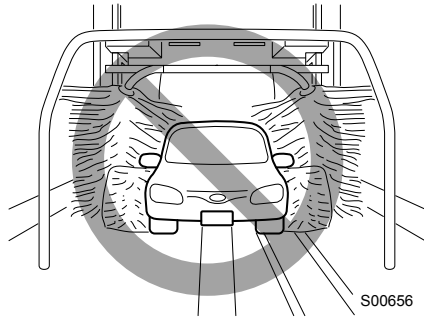

- The Pre-Collision Braking System may activate in the following situations. Therefore concentrate on safe driving.
  - When passing through an automatic gate (opening and shutting)
  - When driving close to the vehicle in front
  - When driving in a location where the grade of the road changes rapidly

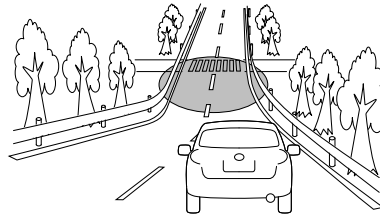
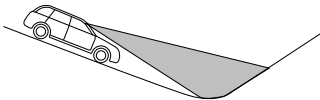

- When visibility is poor due to sand, smoke or water vapor in the air, or when the vehicle in front or oncoming traffic causes water, snow, dirt or other substances to obscure the view
- When passing through clouds of steam or smoke, etc.

- When the exhaust gas emitted by the vehicle in front is clearly visible in cold weather, etc.

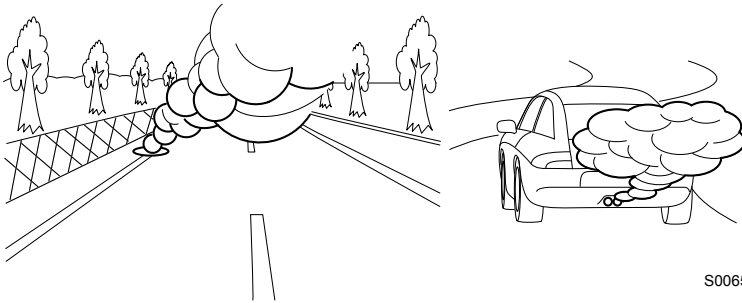

S00652

- When there is an obstacle on a curve or intersection
- When narrowly passing a vehicle or an object
- When stopping very close to a wall or a vehicle in front
- If there is cargo or installed accessories, etc. that are protruding over the edge of the front bumper, the vehicle's length will increase and the system may not be able to prevent a collision.

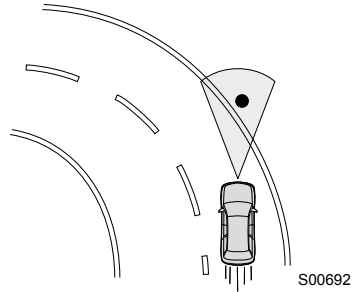

S00692

- If the driver operates the brake pedal during automatic braking, the pedal may feel stiff; however, this is normal. By depressing the brake pedal further you can apply more braking force.

**NOTE**

Some unusual noises may be audible during automatic braking. This is caused by the braking control and is normal.

## ■ Detection of pedestrians

The EyeSight system can also detect pedestrians. The EyeSight system detects pedestrians from their size, shape and movement. The system detects a pedestrian when the contour of the head and shoulders are clear.



S00693

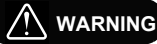

The EyeSight system's Pre-Collision Braking function also treats pedestrians as obstacles. However, depending on the conditions, there may be cases when the system cannot detect a pedestrian. In the following conditions, the possibility that the system may not be able to detect a pedestrian as an object is particularly high.

- When pedestrians are walking in a group
- When a pedestrian is next to a wall or other obstacle
- When a pedestrian is using an umbrella
- When a pedestrian is wearing clothes that are a similar color to the surrounding environment
- When a pedestrian is carrying bulky luggage
- When a pedestrian is bent over, crouching down or lying down
- When a pedestrian is in a dark location
- When a pedestrian suddenly crosses in front of you from the side or suddenly runs in front of you

## Pre-Collision Braking System operation

When there is an obstacle in the forward direction during driving, the system activates in the following sequence in order to warn the driver, activate braking control, and activate the brake lights.

### Following Distance Warning:

When the system determines that there is a risk of collision, a buzzer sounds repeated short beeps and the indicators on the multi information display illuminate to warn the driver.

The Following Distance Warning operates when Adaptive Cruise Control is not set.

When the driver depresses the brake pedal to decelerate and achieves a suitable following distance, the warning is canceled.

### First Braking and Warning:

When the system determines that there is a high risk of collision with an obstacle in front, a buzzer sounds repeated short beeps and the indicators on the multi information display illuminate to warn the driver, and braking control is activated and the engine output, in some situations, is also controlled. If the system determines that the amount of evasive action (braking, steering, etc.) taken by the driver has reduced the risk of collision, braking activation is canceled.

### Secondary Braking and Warning:

If the system then determines that the risk of collision is extremely high, the buzzer changes to a continuous beeping sound and stronger braking control is activated. If, despite any evasive action taken by the driver, the system subsequently determines that a collision is unavoidable, braking control and the engine output control are continued.

Even after the vehicle has stopped, depress the brake pedal.

### <Apply Brake message>

Until the brake pedal is depressed, a message appears and stays in the pop-up screen area of the multi information display for approximately 2 minutes. A single continuous beep sounds while the message is displayed.

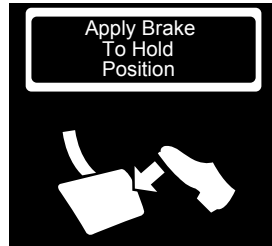

S01124

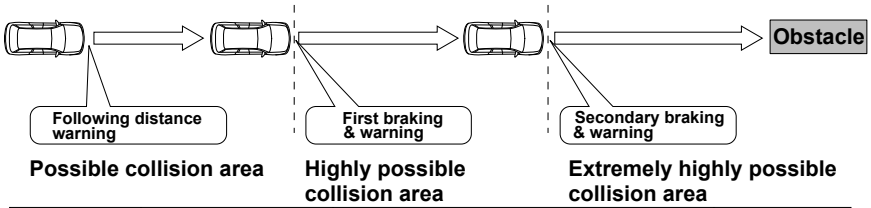

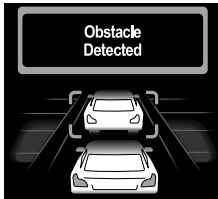
| Operating system           | Strength of Automatic Braking | Indication on the multi information display                                       | Warning buzzer type  |
|----------------------------|-------------------------------|---|----------------------|
| Following distance warning | No brake control              |  | Repeated short beeps |
| First braking              | Moderate                      |   | Repeated short beeps |
| Secondary braking          | Strong                        |   | Continuous beep      |

S01141



**NOTE**

- After the vehicle has come to a stop through secondary braking, release brake control in the following manner.
  - Depress the brake pedal.
  - Depress the accelerator pedal (except when the select lever is in the **[N]** position).
  - When the selector lever is in the **[P]** position
- After stopping with secondary braking, in the following cases, operate electronic parking brake and release brake control. (For details about how to release the electronic parking brake, refer to the Owner's Manual for your vehicle.)
  - When approximately 2 minutes have elapsed since stopping and not depressing the brake pedal
  - When any door (except the rear gate/trunk) was opened
  - When EyeSight is temporarily stopped
  - When there is a malfunction in the EyeSight system

- Neither first braking or secondary braking will operate in the following cases.
  - When your vehicle speed is approximately 1 MPH (1 km/h) or less (When the selector lever is in the **[N]** position and your vehicle speed is approximately 2 MPH (4 km/h) or less) or 100 MPH (160 km/h) or more
  - When VDC is active
- If the system detects the brake lights of the vehicle in front, your vehicle will start decelerating earlier than if it does not.
- There are some cases where the first braking is applied for a longer period of time. One of the reasons for this is due to a large speed difference with an obstacle in front. In those cases, stronger or weaker braking control may be activated.

## Pre-Collision Braking Assist operation

When the Pre-Collision Braking System is activated (when the system determines that there is a high risk of collision with an obstacle in front), if the driver depresses the brake pedal, the system determines that this is emergency braking and activates braking assist automatically.

### CAUTION

If the driver depresses the brake pedal manually while following distance warning is activated, the Pre-Collision Braking Assist will not work. (The vehicle decelerates with the normal braking force operated by the driver.)

### NOTE

- Pre-Collision Braking Assist function does not operate when the vehicle speed is approximately 7 MPH (10 km/h) or less or 100 MPH (160 km/h) or more.
- For information about the braking assist function, refer to the Owner's Manual for your vehicle.



## Turning off the Pre-Collision Braking System

Pressing and holding the Pre-Collision Braking System OFF switch for approximately 2 seconds (or longer) turns off the Pre-Collision Braking System (including Pre-Collision Brake Assist). When 1 short beep sound emits, this control is turned off and the Pre-Collision Braking System OFF indicator light on the instrument panel illuminates.

To turn the control back on, press and hold the Pre-Collision Braking System OFF switch for approximately 2 seconds or longer again. When this control is turned on, the Pre-Collision Braking System OFF indicator light turns off.

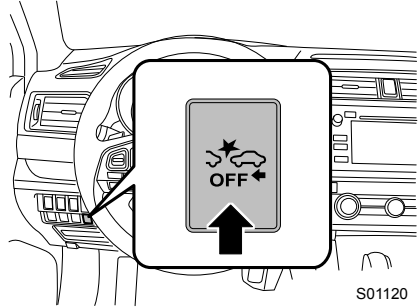

S01120



### NOTE

- When the Pre-Collision Braking System is turned off, the Pre-Collision Throttle Management Control function is also turned off.
- Even when the Pre-Collision Braking System is turned off, if the ignition switch is turned off and the engine is then restarted, the Pre-Collision Braking System will be turned on. The system default setting when the vehicle is restarted is "ON".

## Pre-Collision Braking System OFF indicator light

This indicator light illuminates when the ignition switch is turned to the ON position, and then flashes for approximately 7 seconds after the engine starts. It turns off when the Pre-Collision Braking System is turned off. It also illuminates under the following conditions.

- When the EyeSight system has a malfunction  
⇒ Refer to page 78.
- When the EyeSight system has stopped temporarily  
⇒ Refer to page 79.

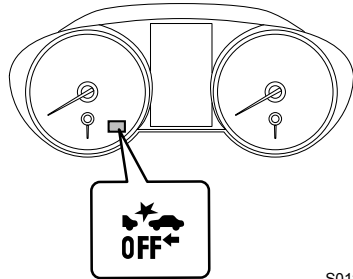

S01121



**NOTE**

When the Pre-Collision Braking System OFF indicator light is turned on, the Pre-Collision Braking System (including the Pre-Collision Braking Assist function) does not operate.

# Adaptive Cruise Control

Adaptive Cruise Control is a driving support system intended to allow more comfortable driving on expressways, freeways and interstate highways. The vehicle in front in the same traffic lane is detected by means of the stereo cameras, and your vehicle tracks the vehicle in front (up to the maximum speed of the set vehicle speed) while automatically maintaining a following distance that corresponds to the speed of the vehicle in front. Through operation of the electronic parking brake, the system uses the vehicle's conventional braking system to stop your vehicle when the vehicle in front is stopped. The vehicle is capable of being controlled at a speed between approximately 0 and 90 MPH (145 km/h). Please remember that you should not exceed posted speed limits.



## WARNING

- This system does not provide the driver with an automatic driving function that handles all traffic conditions.
  - Do not rely excessively on Adaptive Cruise Control. This system is not intended to assist in driving when the driver is not paying full attention to what is ahead of him/her due to distractions or a lack of concentration while driving, or under conditions of poor visibility. It is not intended to prevent rear-end collisions.  
Strive for safe driving at all times. Always maintain a safe following distance behind the vehicle in front of you, pay attention to your surroundings and the driving conditions, and operate the brake pedal and take other action as necessary.
  - Set the set vehicle speed within a range that is appropriate to the road conditions and surrounding environment.
  - Before using the system, perform a daily inspection and verify that there are no malfunctions of the tires or brakes.  
⇒ Refer to the separate "Warranty and Maintenance Booklet".
  - The system may not operate correctly under the conditions listed below. When these conditions occur, do not use Adaptive Cruise Control.
    - The tire pressure is not correct.<sup>\*1</sup>
    - The temporary spare tire is installed on any wheel.<sup>\*1</sup>
    - Tires that are worn or have large variations in wear conditions are installed.<sup>\*1</sup>
    - Tires other than those of the designated size are installed.<sup>\*1</sup>
    - Flat tires have been fixed temporarily with a tire repair kit.
    - The suspension has been modified (including a genuine SUBARU suspension that has been modified).
    - Any object that disturbs the stereo cameras' view is installed on the vehicle.
    - The headlights are dirty or they have snow and ice or dirt on them. (Objects are not correctly illuminated and are difficult to detect.)
    - The optical axes are not aligned correctly. (Objects are not correctly illuminated and are difficult to detect.)
    - The lights including headlights and fog lamps have been modified.
    - Vehicle operation has become compromised due to an accident or malfunction.
    - The brake system warning light is illuminated in red.
    - A heavy cargo is loaded onto or inside the vehicle.
    - The maximum number of occupants is exceeded.
    - There is something wrong with the combination meter; such as when the lights do not illuminate, the beeps do not sound, the display is different from when it is normal, etc.<sup>\*2</sup>
- <sup>\*1</sup>: The wheels and tires have functions that are critically important. Be sure to use the correct ones. For details, refer to the Owner's Manual for your vehicle.
- <sup>\*2</sup>: For details about the combination meter, refer to the Owner's Manual for your vehicle.

- Adaptive Cruise Control is designed for use on expressways, freeways, toll roads, interstate highways and similar limited access roads. It is not intended to be used in city traffic. In the following conditions, do not use Adaptive Cruise Control. Doing so may result in an accident.
  - Ordinary roads (roads other than those mentioned above)  
Depending on the driving environment (complexity of roads and other factors), the system may not be able to perform as the traffic conditions require, and that may result in an accident.
  - Roads with sharp curves or winding roads
  - Frozen roads, snow-covered roads or other slippery road surfaces  
The tires may spin, causing loss of control of the vehicle.
  - Traffic conditions when frequent acceleration and deceleration make it difficult to maintain the following distance  
It may not be possible for the system to perform as the traffic conditions require.
  - Steep downhill grades  
The set vehicle speed may be exceeded.
  - On a steep continuous downhill grade  
The brakes may overheat.
  - Roads and overpasses with repeated steep uphill and downhill grades  
Detection of the vehicle in front may be lost, or the road surface may be detected instead of the vehicle in front, making correct control impossible.
  - When entering a sharp curve into an interchange or junction, or a service area, parking area, toll booth or other facilities  
Detection of the vehicle in front may not be possible.
  - When there are changes in brightness, such as at a tunnel entrance or exit
  - When visibility is poor due to sand, smoke or water vapor blowing in the wind, or when the vehicle in front or oncoming traffic causes water, snow, dirt or dust to obscure the view  
Detection of the vehicle in front may be lost, or water or other substances may be incorrectly detected instead, making correct control impossible.

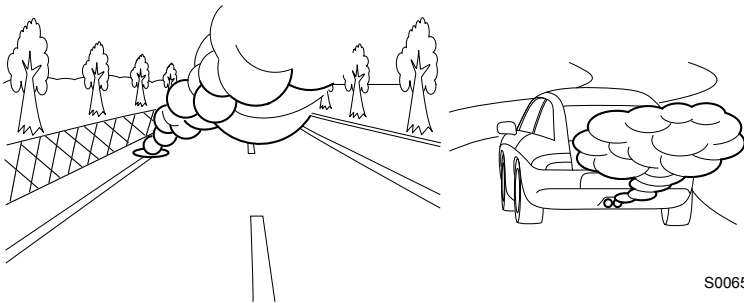

S00652

- When there is snow, frost, dirt or dust on the windshield or it is clouded

Continued on next page ⇒

⇒ Continued from previous page

- When water droplets from rain or the window washer, or dirt has not been fully wiped off the windshield  
It may not be possible to detect the vehicle in front, making correct control impossible.
- When the stereo cameras' field of view is obstructed (for example by a canoe on the roof of the vehicle)
- The stereo cameras may have difficulty detecting the following objects or conditions. Operate the brake pedal and take other actions as necessary.
  - Vehicles at significantly different speeds (vehicles driving slowly, stopped or oncoming vehicles, etc.)
  - Vehicles cutting into your lane
  - Motorcycles, bicycles, pedestrians and animals, etc.
  - When light is poor in the evening or early morning
  - When driving at night or in a tunnel without the headlights on
  - When driving at night or in a tunnel when there is a vehicle in front that does not have its taillights on
  - When affected by strong light from the front (sunlight or headlight high beams, etc.)
  - Vehicles in front that have a rear aspect that is low, small or irregular (the system may recognize another part of the vehicle and will determine operation from that)
    - An empty truck or trailer that has no cargo in the cargo bed being affected by wind
    - Vehicles that have cargo protruding from their back ends
    - Non-standard shaped vehicles (vehicle transporters or vehicles with a sidecar fitted, etc.)
    - Vehicles that are low
  - Objects that are located close to the bumper of your vehicle
- When you do not want to use Adaptive Cruise Control, be sure to turn the  (CRUISE) switch off. If the switch is left on, cruise control may be accidentally engaged, possibly resulting in an accident.
- Before using Adaptive Cruise Control, be sure to fully verify the safety of the vehicle occupants and the area around the vehicle. Never operate the cruise control from outside the vehicle.

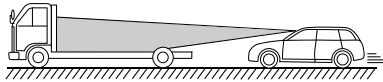

S00654

### Detection of the vehicle in front by the EyeSight stereo cameras

- Under the following road conditions or conditions of your vehicle, detection of the vehicle in front may not be possible. Vehicles in neighboring traffic lanes or roadside objects may also be incorrectly detected. Under conditions such as these, do not use Adaptive Cruise Control. If cruise control is currently in use, operate the brake pedal and take other action as necessary.

- When tracking begins from a short following distance, such as when the vehicle in front is a vehicle that cut into your lane

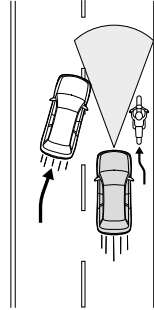

S00639

- When driving on curved roads, at the start and end of a curve and on roads with continuous curves (These conditions make it difficult for the system to detect vehicles because they are outside the detectable area.)

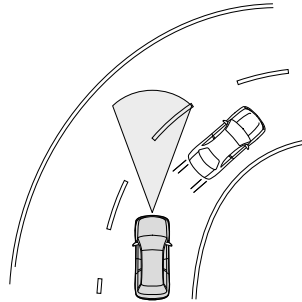

S00640

- When driving on an on-ramp or off-ramp to a freeway, highway, or other restricted access road (EyeSight Adaptive Cruise Control is not designed for use in this kind of driving environment.)
- When driving in an urban, or suburban environment (Adaptive Cruise Control is not appropriate for use in these driving areas. Adaptive Cruise Control should only be used on limited-access highways.)

Continued on next page ⇒

⇒ Continued from previous page

- When the vehicle in front is not directly ahead of your vehicle and is shifted to one side

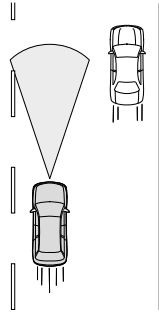

S00641

- When there is an obstacle at the side of the road
- When the relative speed difference compared to the vehicle in front is large
- When a vehicle cuts into your lane in front of you
- When the distance between vehicles is extremely short
- When your vehicle is drifting within the lane
- When driving on a bumpy or unpaved road surface
- When driving on a road with extremely narrow lanes, such as when traffic restrictions are in effect or in areas where construction work is taking place

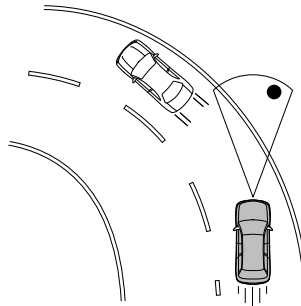

S00642

- When normal driving has become compromised due to an accident or malfunction
- When extremely heavy cargo is loaded in the cargo area, rear seat or trunk of your vehicle
- There are limits to the capabilities of Adaptive Cruise Control. Even when the vehicle in front is detected, the system may not be able to decelerate in time in cases such as when the difference in speeds is large or when the vehicle in front decelerates suddenly. Operate the brake pedal and decelerate as necessary.
- If the buzzer sounds frequently, do not use Adaptive Cruise Control.
- Even when the following distance is short, the “brake more” warning may not activate in the following cases.
  - When the relative speed difference compared to the vehicle in front is small (the two vehicles are travelling at almost the same speed)
  - When the vehicle in front is traveling faster than your vehicle (the following distance is gradually increasing)
  - When another vehicle cuts into your lane very close to your vehicle
  - When the vehicle in front decelerated suddenly
  - When there are repeated uphill and downhill grades



- After Adaptive Cruise Control has started, it maintains control continuously according to the behavior of the vehicle in front. When your vehicle comes to a stop if the vehicle in front has stopped, the stay-stopped function is engaged. However, if the EyeSight stereo cameras lost detection of the vehicle in front, the system may not stop your vehicle. Operate the brake pedal and maintain the correct following distance as necessary. Be aware that the EyeSight system has difficulty detecting objects or vehicles that have a relative speed in comparison to your vehicle. Therefore, if the EyeSight system loses detection just as you are approaching a line of stopped cars, for example - you will have to brake manually.
- There is no possibility that the vehicle will automatically begin moving from a stay-stopped condition without operation from the driver.
- If the conditions for automatically canceling cruise control (⇒ refer to page 49) are met while the vehicle is stay-stopped, Adaptive Cruise Control is canceled and for safety reasons, the electronic parking brake is automatically applied.
- Braking may not be sufficient depending on the following conditions. Operate the brake pedal and decelerate as necessary.
  - Vehicle conditions (amount of load, number of occupants, etc.)
  - Road conditions (grade, slipperiness, shape, bumps, etc.)
  - Vehicle maintenance status (brake systems, tire wear, air pressure, temporary spare tire is being used, etc.)
  - When the brakes are cold. (For example, just after the engine is started or when the outside temperature is low.)
  - For a short period of time when driving after the engine is started until the engine has warmed-up
  - When the brakes are overheated on downhill grades (braking effectiveness may be reduced)
  - When driving in rain or after washing the vehicle (the brakes may become wet and braking effectiveness may be reduced)
  - When towing a trailer or another vehicle, etc.





## How to use Adaptive Cruise Control

Adaptive Cruise Control is available when the engine is turned on.

### ■ Setting Adaptive Cruise Control

(1) Setting Adaptive Cruise Control to standby status

Press the  (CRUISE) switch. At this time, " " (Adaptive Cruise Control), your vehicle indicator and the "following distance setting" are displayed on the EyeSight display area in the multi information display.

The set vehicle speed display will read "-- MPH".

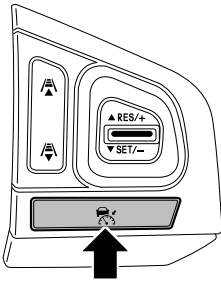

S01109

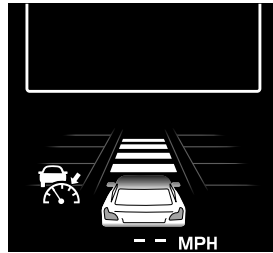

S01110

If the switch is pressed once more, the EyeSight display will turn off. It will also automatically turn off when the engine is stopped.

To set ready status:

Adaptive Cruise Control can be set when all of the following conditions are met and **READY** is displayed on the EyeSight display area.

- All doors (except the rear gate/trunk) are closed.
  - The driver's seatbelt is fastened.
  - The electronic parking brake is not engaged (The brake system warning light is turned off.).
  - The selector lever is in the **D** position and the paddle shift is not operated.
  - The brake pedal is not depressed.
  - EyeSight operation is not temporarily stopped.
- ⇒ Refer to page 79.
- The road is not a steep slope.
  - The steering wheel has not been turned significantly in either direction.
  - X-mode is not turned on.
  - The vehicle speed is between approximately 0 MPH (0 km/h) and 90 MPH (145 km/h).

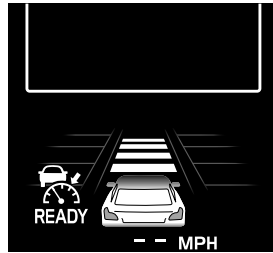

S01111

## (2) Setting Adaptive Cruise Control

Press the RES/SET switch to the "SET/-".

Adaptive Cruise Control is now set, and cruise control will start.

If no vehicle in front has been detected, the vehicle drives at the constant set target speed.

When Adaptive Cruise Control is set, the set speed and **SET** are displayed on the EyeSight display area.

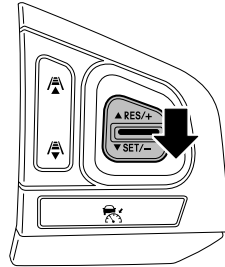

S01112

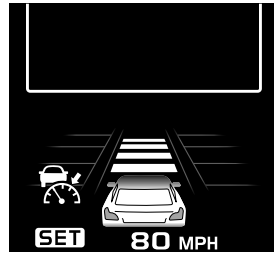

S01114

**NOTE**

- The target vehicle speed can be set between 25 MPH (40 km/h) and 90 MPH (145 km/h).
- If the vehicle speed is approximately 25 MPH (40 km/h) or less when the vehicle speed is set, the set vehicle speed is set to 25 MPH (40 km/h).

When a vehicle in front is detected, a buzzer sounds 1 short beep and the lead vehicle indicator will illuminate.  (white) will turn green.

The vehicle tracks the lead vehicle in front and maintains the selected following distance. At this time, the speed upper limit is the set vehicle speed. If the vehicle in front is no longer detected, a buzzer sounds 1 short beep and the lead vehicle indicator turns off.

 (green) will turn white.

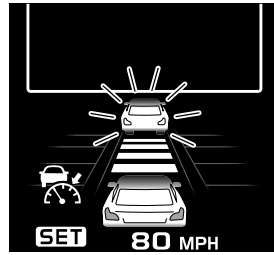

S01113



### NOTE

The buzzer sound (lead vehicle acquisition sound) that occurs when a vehicle in front is detected or no longer detected while Adaptive Cruise Control is set can be turned off by customization.

⇒ Refer to page 81.

### Operation of Adaptive Cruise Control

- When no vehicle in front is detected

The vehicle drives constantly at the set target vehicle speed between approximately 25 MPH (40 km/h) and 90 MPH (145 km/h).

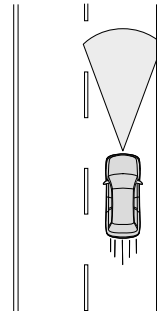

S00643

- When a vehicle in front is detected

The vehicle tracks the lead vehicle in front, and will maintain the chosen following distance (there are three settings), up to the set target vehicle speed - between 25 MPH (40 km/h) and 90 MPH (145 km/h).

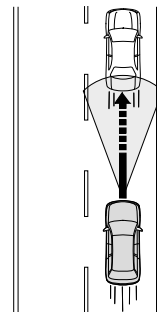

S00644

- If your vehicle no longer detects the vehicle in front

The vehicle gradually accelerates back to the set target vehicle speed and will drive at that constant speed.

If a vehicle in front is detected while accelerating to the set target vehicle speed, vehicle tracking will be started again.

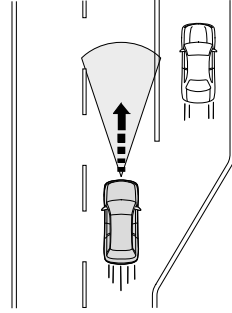

S00646

**CAUTION**

If the driver operates the brake pedal during automatic braking, the pedal may feel stiff; however, this is not a malfunction. By depressing the brake pedal further you can apply more braking force. When the brake pedal is released it will return to its original condition.

**NOTE**

- When the brakes are applied by Adaptive Cruise Control, the vehicle's brake lights will illuminate.
- Even if there is no lead vehicle present, on a downhill grade, the Adaptive Cruise Control's automatic brake may operate in order to maintain the set target vehicle speed.
- Some noises may be audible during automatic braking. This is caused by the braking control and does not indicate a malfunction.
- To temporarily accelerate quickly, use the accelerator pedal. After accelerating, the vehicle will gradually return to the set target vehicle speed shown in the gauge cluster.
- There are cases where the vehicle in front has turned off the road while your vehicle is still controlled by the automatic braking operation that has activated due to the deceleration of the vehicle in front of yours. In those cases, the brake will be automatically released gradually. Depress the accelerator pedal if necessary.
- The lead-vehicle tracking function has the following characteristics:
  - If the lead vehicle's brake lamp is detected, deceleration is started more quickly than without detection.
  - Responsiveness to the acceleration operation to the set vehicle speed is better when changing to the fast lane than when changing to the cruising lane.

## ■ Increasing the set vehicle target speed

### ● Using the RES/SET switch

Push the RES/SET switch in the following way while you are driving with Adaptive Cruise Control on:

- Push the RES/+ switch towards the position (1) briefly: the set vehicle speed will increase in increments of 1 MPH (1 km/h) every time the button is pushed.
- Push the RES/+ switch towards the position (1) for longer: the set vehicle speed will increase in increments of 1 MPH (1 km/h) while the button is being pushed.
- Push the RES/+ switch towards the position (2) briefly: the set vehicle speed will increase in increments of 5 MPH (5 km/h) every time the button is pushed.
- Push the RES/+ switch towards the position (2) for longer: the set vehicle speed will increase in increments of 5 MPH (5 km/h) while the button is being pushed.

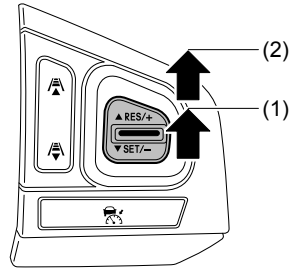

S01115

The set vehicle target speed is shown on the EyeSight display. Using this method, you can 'fine tune' the vehicle's set target speed.

### ● Using the accelerator pedal

Depressing the accelerator pedal will increase vehicle speed. Once the preferred speed has been attained, push the RES/SET switch to SET/-. When the switch is pressed, the new vehicle target speed will be set. The new set vehicle speed will be displayed in the EyeSight display area.

#### CAUTION

- When Adaptive Cruise Control is operating, the actual vehicle speed is controlled according to the lead vehicle. Therefore, if the RES/SET switch is pressed to the "RES/+" and set to a speed higher than the speed of the lead vehicle, the vehicle will not accelerate - it will maintain a safe following distance as the first priority. However, because doing so changed the set vehicle target speed, when the lead vehicle is no longer detected (for example, if you change to a freeway lane with no vehicles in front), the vehicle will accelerate to that new set target speed. Change the set vehicle target speed while briefly checking the value shown in the set speed display on the EyeSight display.
- When the accelerator pedal is depressed with Adaptive Cruise Control on, automatic braking control and warnings by Adaptive Cruise Control will not occur. However, if there is a high risk of collision with an obstacle in front of the vehicle at this time, the warning and braking control of the Pre-Collision Braking System may activate.

## ■ Decreasing the set vehicle target speed

### ● Using the RES/SET switch

Push the RES/SET switch in the following way while you are driving with Adaptive Cruise Control on:

- Push the SET/- switch towards the position (1) briefly: the set vehicle speed will decrease in increments of 1 MPH (1 km/h) every time the button is pushed.
- Push the SET/- switch towards the position (1) for longer: the set vehicle speed will decrease in increments of 1 MPH (1 km/h) while the button is being pushed.
- Push the SET/- switch towards the position (2) briefly: the set vehicle speed will decrease in increments of 5 MPH (5 km/h) every time the button is pushed.
- Push the SET/- switch towards the position (2) for longer: the set vehicle speed will decrease in increments of 5 MPH (5 km/h) while the button is being pushed.

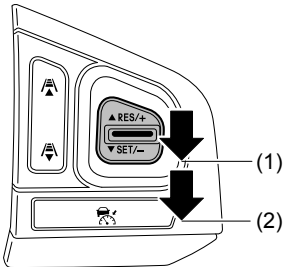

S01116

The set vehicle target speed is shown on the EyeSight display.

### ● Using the brake pedal

- (1) Depress the brake pedal to decrease the vehicle speed. (Adaptive Cruise Control will be canceled and **SET** will be turned off.)
- (2) When the desired speed is reached, press the RES/SET switch to the "SET/-". The speed at the time of pressing the switch will be set as the new vehicle speed, and it appears in the EyeSight display area.

## ■ Accelerating temporarily

Depress the accelerator pedal to accelerate temporarily.

When the accelerator pedal is released, the vehicle returns to the set vehicle speed.

## ■ Decelerating temporarily

Depress the brake pedal to decelerate temporarily. When the brake pedal is depressed, Adaptive Cruise Control will be canceled. The **SET** will be turned off while the set vehicle target speed remains displayed on the EyeSight display area.

Release the brake pedal and press the RES/SET switch to “RES/+” to reset the set vehicle target speed.

**SET** will be turned off.

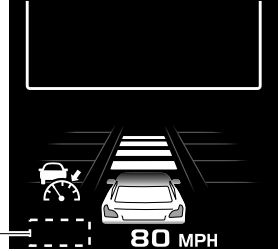

S01117

### CAUTION

Ordinarily, while Adaptive Cruise Control is functioning, acceleration and deceleration are performed automatically according to the speed of the lead vehicle (if one is detected). However, when your vehicle approaches a lead vehicle, for example if it is necessary to accelerate for a lane change or other reason, and if the vehicle in front suddenly decelerates, or if another vehicle cuts into your path, operate the accelerator pedal or brake pedal and accelerate or decelerate as appropriate for the existing conditions.

## ■ Changing the following distance from the vehicle in front

The following distance from the vehicle in front setting can be changed in 4 stages.

▲ : When the switch ( ▲ side) is pressed, the following distance will be longer.

▼ : When the switch ( ▼ side) is pressed, the following distance will be shorter.

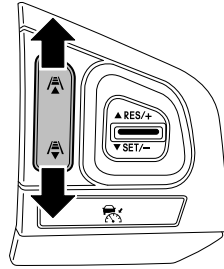

S01118



### NOTE

The following distance changes according to the vehicle speed and is further the faster that the vehicle is traveling at.

#### <Approximate guide to following distances>

| Following distance indicator | When you vehicle speed is 25 MPH (40 km/h) | When you vehicle speed is 60 MPH (100 km/h) |
|------------------------------|--|---|
|                              | Approx. 95 ft (30 m)                       | Approx. 190 ft (60 m)                       |
|                              | Approx. 80 ft (25 m)                       | Approx. 160 ft (50 m)                       |
|                              | Approx. 65 ft (20 m)                       | Approx. 130 ft (40 m)                       |
|                              | Approx. 50 ft (15 m)                       | Approx. 100 ft (30 m)                       |



## ■ Stay-stopped function

If the vehicle in front comes to a stop while you are utilizing Adaptive Cruise Control, your vehicle will also come to a stop and will stay stopped.

When your vehicle comes to stop after the vehicle in front has stopped, Adaptive Cruise Control is paused and the stay-stopped function is engaged. **[SET]** on the EyeSight display area is turned off and **[HOLD]** is displayed. At the same time,  is turned back to white.

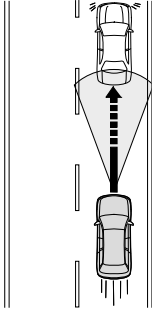

S00647

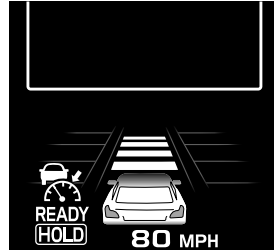

S01140

## ● Resuming Adaptive Cruise Control in stay-stopped status

### ▼ Setting using the RES/SET switch

Press "SET/-" (⇒ Refer to page 39 "(2) Setting Adaptive Cruise Control".)

Press "RES/+" (⇒ Refer to page 51 "Returning to a vehicle speed that was previously set".)



### NOTE

When Adaptive Cruise Control is resumed from stay-stopped status and the vehicle in front accelerates, your vehicle will also accelerate and continue to track the vehicle in front at the previously set following distance. However, if the lead vehicle does not start moving or pauses, stay-stopped status will be automatically restored after approximately 3 seconds.

### ▼ Setting with the accelerator pedal

Depressing the accelerator pedal while stay-stopped is engaged cancels stay-stopped status. At this time, Adaptive Cruise Control is resumed. The vehicle will attempt to travel at the previously set vehicle target speed unless a lead vehicle is detected. If a lead vehicle is detected, Adaptive Cruise Control will maintain the previous following distance setting.



#### NOTE

If the accelerator pedal is only slightly depressed, the stay-stopped function may not be canceled, and the Adaptive Cruise Control may not be resumed.

### ● Canceling the stay-stopped function

If any of the following operations is performed, the stay-stopped function will be canceled and the Adaptive Cruise Control will be canceled at the same time.

- The brake pedal is depressed.
- The  (CRUISE) switch is pressed.
- The electronic parking brake switch is pressed to apply the Electronic Parking Brake.



#### WARNING

- While the stay-stopped function is engaged, do not exit the vehicle.
- The stay-stopped function is not a replacement for engaging the parking brake.

When parking, always apply brakes manually to come to a full stop, then set the electronic parking brake.



#### CAUTION

The stay-stopped function of cruise control will be canceled under the following conditions:

- The vehicle is in stay-stopped mode for approximately 2 minutes or more. (A buzzer will sound 5 intermittent beeps and 1 long beep.)
- Any condition in which automatic cancellation is met. (A buzzer sounds 1 long beep.)

⇒ Refer to page 49.

After the stay-stopped function has been canceled, the Electronic Parking Brake will be automatically applied and the brake system warning light will illuminate. However, if any canceling condition for the Electronic Parking Brake (i.e. the interlock system with the accelerator pedal, switch operation of the electronic parking brake, etc.) is fulfilled, the Electronic Parking Brake will not work. (For details, refer to the Owner's Manual for your vehicle.)

If the accelerator pedal is only slightly depressed while the stay-stopped function is activated, the stay-stopped function of cruise control may be canceled, and the Electronic Parking Brake may not work.

## ● Setting Adaptive Cruise Control while the Electronic Parking Brake is applied

If the Electronic Parking Brake is applied, then before setting cruise control, release the Electronic Parking Brake by depressing the accelerator pedal or by other specified means. For details of how to release the electronic parking brake, refer to the Owner's Manual for your vehicle.

## ■ Canceling Adaptive Cruise Control

### ● Canceling by driver operation

Either of the following operations will cancel Adaptive Cruise Control.

- Depress the brake pedal.

**SET** will be turned off while the set vehicle target speed remains displayed on the EyeSight display area.

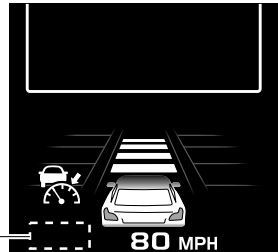

**SET** will be turned off.



S01117

- Press the  (CRUISE) switch.

**SET** will be turned off while the set vehicle target speed remains displayed on the EyeSight display area.

When the  (CRUISE) switch is pressed again,  will be turned off and Adaptive Cruise Control will be turned off.

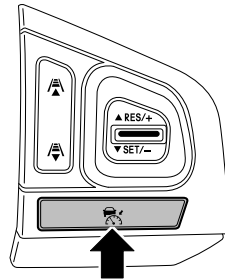

S01109

## ● Automatic cancellation by the system

In the following cases, a buzzer will sound a single long beep and Adaptive Cruise Control is automatically canceled. (OFF is displayed on the EyeSight display area.) If the stay-stopped function is engaged, the electronic parking brake will be automatically engaged.

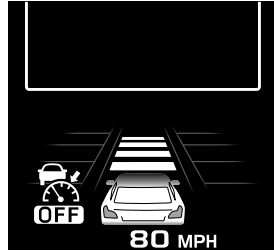

S01265

### • Conditions for automatic cancellation

- The grade of the road is very steep.
- ABS, Vehicle Dynamics Control or Traction Control Function is activated.
- The vehicle speed has exceeded approximately 100 MPH (160 km/h) while cruise control is set.
- The steering wheel was turned significantly in either direction.
- The transmission select lever is moved to a position other than **D**.
  - Cruise control can be resumed after the transmission select lever is returned to the **D** position.
- A paddle shift switch is operated while driving when the transmission select lever is in the **D** position.
  - Cruise control can be resumed again after the shift indicator returns to **D**.
- Any door (except the rear gate/trunk) is opened.
- The driver's seatbelt is unfastened.
- The electronic parking brake is engaged manually. (When the brake system warning light is illuminated or flashing.)
- The X-mode is turned on (the X-mode indicator light  illuminates).
  - Cruise control can be resumed after the X-mode is turned off.
- EyeSight operation has temporarily stopped.

⇒ Refer to page 79.

- EyeSight is malfunctioning.

⇒ Refer to page 78.

- The Pre-Collision secondary braking has activated.



**WARNING**

Do not use Adaptive Cruise Control on slippery roads. Doing so may result in an accident.



**CAUTION**

When shifting the selector lever to the **[N]** position, Adaptive Cruise Control will be automatically canceled. Do not shift the lever to the **[N]** position unless it is an emergency. Otherwise the engine brake may not operate, which could cause an accident.



**NOTE**

- If EyeSight operation has temporarily stopped, the Pre-Collision Braking System OFF indicator light and Lane Departure Warning OFF indicator light illuminate, and the EyeSight temporary stop indicator is displayed on the multi information display.

⇒ Refer to page 79.

- If EyeSight is malfunctioning, the EyeSight warning indicator is displayed on the multi information display, and the Pre-Collision Braking System OFF indicator light and Lane Departure Warning OFF indicator light will also illuminate. If this occurs, stop the vehicle in a safe location and then turn off the engine and restart it. If the indicators remain illuminated after restarting the engine, Adaptive Cruise Control cannot be used. This will not interfere with ordinary driving; however the system should be inspected by a SUBARU dealer as soon as possible.

⇒ Refer to page 78.

- When the operation of Adaptive Cruise Control has been automatically canceled, perform the set cruise control operation again after the condition that caused the cancellation has been corrected. If the cruise control function cannot be set even after the condition has been corrected, EyeSight may be malfunctioning. This will not interfere with ordinary driving; however contact a SUBARU dealer and have the system inspected.

## ■ Returning to a vehicle speed that was previously set

The vehicle speed which was previously set is stored in memory.\* To return to set that vehicle speed, press the RES/SET switch to the RES/+. (**SET**) on the EyeSight display area illuminates again to indicate that the system has returned to the set status again.)

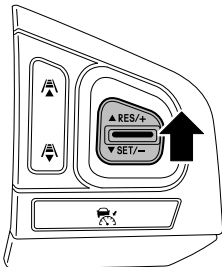

S01133



S01114

### NOTE

\*The vehicle speed stored in memory is erased in the following circumstances:

- The cruise control is turned off by pressing the  (CRUISE) switch.
- Vehicle Dynamics Control or Traction Control Function are activated.
- The cruise control mode was switched from Adaptive Cruise Control to Conventional Cruise Control.

## Other functions

### ■ “Brake more” warning

The “brake more” warning is activated while Adaptive Cruise Control is tracking a lead vehicle. This function warns the driver when it determines that the current level of deceleration by automatic braking control is insufficient.

- When the ‘brake more’ function operates, “Obstacle Detected” will be shown in the pop-up screen area of the multi information display, a lead vehicle indicator will flash, and a buzzer will sound several short beeps.
- When this function activates, depress the brake pedal to decelerate and maintain a correct following distance.

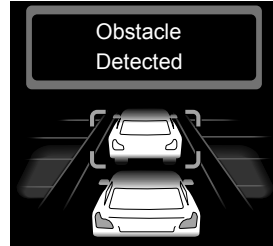



S01119



#### WARNING

- If the buzzer sounds frequently, do not use Adaptive Cruise Control.
- The “brake more” warning will not activate in the following situations.
  - The accelerator pedal is depressed.
  - The brake pedal is depressed.
- Even when the following distance is short, the “brake more” warning may not activate in the following situations.
  - The difference in speed with the vehicle in front is small. (The two vehicles are travelling at almost the same speed.)
  - The vehicle in front is traveling faster than your vehicle. (The following distance is gradually increasing.)
  - Another vehicle cuts into your lane very close to your vehicle.
  - The vehicle in front decelerates suddenly.
  - When there are repeated uphill and downhill grades
- The “brake more” warning may not activate in time in the case of a vehicle that is stopped at the end of a line at a toll gate, at a stop light or intersection or in traffic congestion, or a vehicle that is moving much slower than your vehicle. EyeSight requires a speed differential in order to recognize a potential obstacle and react to it.

**NOTE**

- Vehicles in front in the same traffic lane are detected by the stereo cameras within a distance of approximately 360 ft (110 m) in the forward direction. However the detection distance may be reduced depending on the traffic environment, driving conditions, and conditions of the vehicle in front.
- When driving on a curve, the vehicle may not accelerate, or may decelerate, even if the set speed is higher than the current vehicle speed.
- If  does not illuminate when the  (CRUISE) switch is pressed, there may be a malfunction in the system. Contact a SUBARU dealer and have the system inspected.



# Pre-Collision Throttle Management

When an obstacle is detected in front of the vehicle, and the vehicle is stopped or traveling very slowly, if the system determines that the accelerator pedal has been depressed by more than the necessary amount (due to driver error), it greatly restricts engine output and ensures that vehicle forward movement is slower than normal in order to give the driver additional time to brake or react.

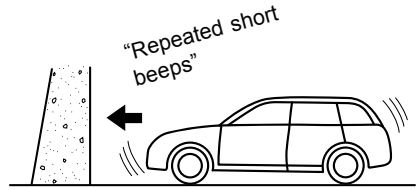

S01125

During system operation, a buzzer will sound several short beeps, and "Obstacle Detected" will be shown on the pop-up display area of the multi information display. The lead vehicle indicator will also flash.

This function only activates when the transmission select lever is in the **D** or **M** position.

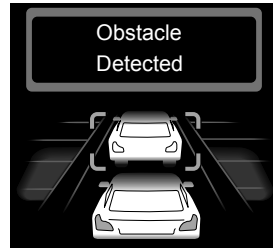

S01119



## WARNING

**Do not rely excessively on Pre-Collision Throttle Management. Pre-Collision Throttle Management is not designed to help you avoid collisions in many situations. Always check the selector lever and pedal positions as well as the surrounding environment before starting and operating the vehicle. Relying only on Pre-Collision Throttle Management could result in an accident.**

- Pre-Collision Throttle Management is not designed to maintain the vehicle in a stopped condition.
- Pre-Collision Throttle Management will not reduce acceleration under all conditions. It is also not designed to prevent collisions.
- Pre-Collision Throttle Management will operate when an obstacle is detected in front. However, this function will not reduce acceleration in cases where no obstacle is recognized (for example when approaching a cliff, etc.)
- Do not intentionally depress the accelerator pedal excessively when there are obstacles nearby. If the driver relies only on Pre-Collision Throttle Management to control acceleration, collisions may occur.

- If your vehicle is trapped on a railroad crossing and you are trying to escape by driving through the crossing gate, the stereo cameras may recognize the crossing gate as an obstacle and Pre-Collision Throttle Management system may activate. In this case, remain calm and either continue to depress the accelerator pedal or turn off the Pre-Collision Throttle Management system.

⇒ Refer to page 59.

- Pre-Collision Throttle Management may not activate depending on the following conditions:

- The distance between your vehicle and the obstacle, speed difference, and lateral displacement (amount of offset)

- Recognition status of the stereo cameras

In particular, the function may not activate in the following cases:

- Bad weather (for example heavy rain, a blizzard or thick fog)
- When visibility is poor due to sand or smoke in the air
- When light is poor in the evening, early morning, or at night
- In a dark area (indoor parking area, etc.)
- When there is an obstacle outside the area illuminated by the headlights
- When affected by strong light from the front (for example sunlight at sunrise or sunset headlight beams, etc.)
- When there is snow, frost, dirt or dust on the windshield, or it is clouded
- When fluid has not been fully wiped off the windshield during or after use of the window washer
- When obstacles cannot be correctly recognized due to water droplets from rain or the washer, or the wiper blades obstructing the stereo cameras' field of view
- When the stereo cameras' field of view is obstructed (for example by a canoe on the roof of the vehicle)
- With low obstacles (low wall, crash barrier, low vehicle, etc.)
- When the size and height of an obstacle is smaller than the limitations of the stereo cameras' recognition capability
  - With small animals or children.
  - With pedestrians who are sitting or lying down
- When the rear portion nearest your vehicle is too small or too close (such as a trailer or oncoming vehicle) the system may not recognize the part of that vehicle which is closest to you.

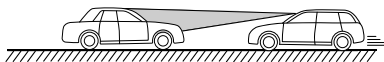
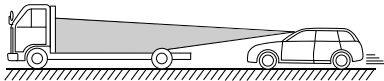

S00771

Continued on next page ⇒

⇒ Continued from previous page

- When there is a fence or wall, etc., with a uniform pattern (striped pattern, brick, etc.) or with no pattern in front
- When there is a wall or door made of glass or a mirror in front
- When an obstacle (another vehicle, motorcycle, bicycle, pedestrian, animal or child, etc.) cuts in from the side or jumps out suddenly
- When starting, if you change lanes and your vehicle is immediately behind the obstacle
- On sharp curves, steep uphill grades or steep downhill grades
- When the system determines that steering operation by the driver is intended as evasive action
- For your safety, do not test Pre-Collision Throttle Management on its own. It may operate improperly and cause an accident.

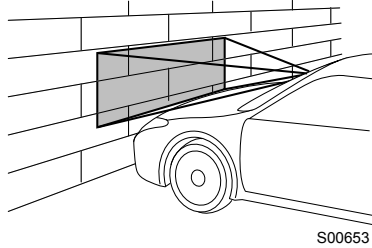

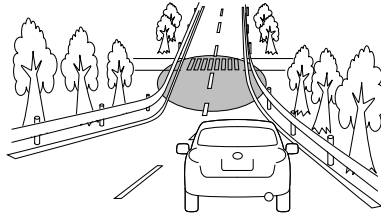
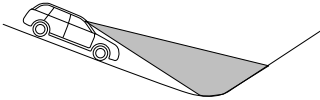

**CAUTION**

- In the following situations, turn off Pre-Collision Throttle Management. Otherwise Pre-Collision Throttle Management may activate unexpectedly.
  - When the vehicle is being towed
  - When loading the vehicle onto a carrier
  - When a chassis dynamometer, free-rollers or similar equipment is used
  - When a mechanic lifts up the vehicle, starts the engine and allows the wheels to spin freely
  - When passing hanging banners, flags or branches, or when thick/tall vegetation is contacting the vehicle
- The Pre-Collision Throttle Management may activate in the following situations. Therefore concentrate on safe driving.
  - When your vehicle is close to the vehicle in front
  - When passing through an automatic gate
  - When your vehicle is in a location where the grade of the road changes rapidly

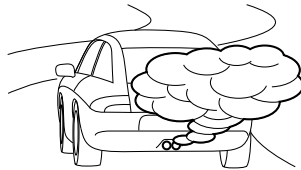
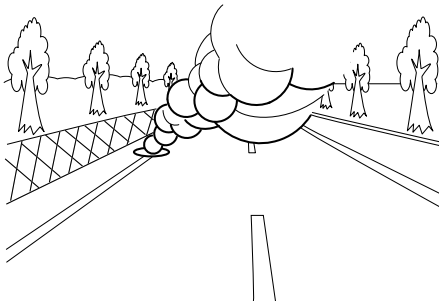

S01264

- When passing through clouds of steam or smoke



S00652

Continued on next page ⇒

⇒ Continued from previous page

- When there is an obstacle on a curve or intersection
- When narrowly passing a vehicle or object
- When stopping very close to a wall or a vehicle in front

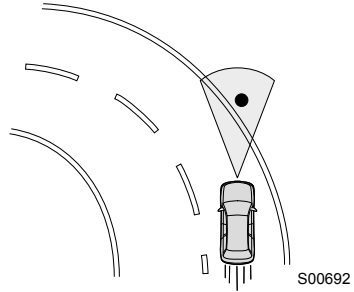

### NOTE

- When the accelerator pedal is depressed for approximately three seconds, Pre-Collision Throttle Management will be released gradually.
- When the Pre-Collision Braking System is turned off, Pre-Collision Throttle Management is also turned off.

⇒ Refer to page 30.

## Turning off Pre-Collision Throttle Management

Pressing and holding the Pre-Collision Braking System OFF switch for approximately 2 seconds or longer will turn off the Pre-Collision Throttle Management System. When 1 short beep sound emits, this function is turned off and the Pre-Collision Braking System OFF indicator light on the instrument panel illuminates.

To turn the system back on, press and hold the Pre-Collision Braking System OFF switch again for approximately 2 seconds or longer. When this function is turned on, the Pre-Collision Braking System OFF indicator light turns off.

⇒ Refer to page 30.

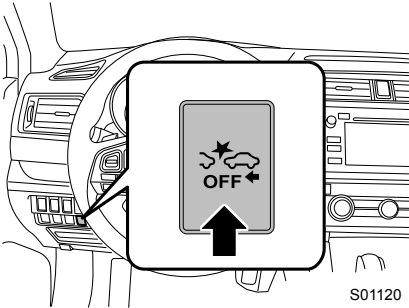

S01120

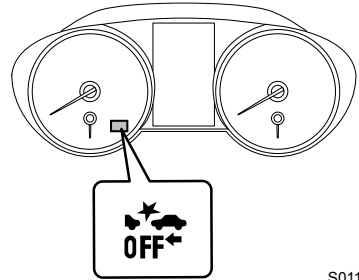

S01121



### NOTE

- When Pre-Collision Throttle Management is turned off, the Pre-Collision Braking System also turns off.
- Even when Pre-Collision Throttle Management is turned off, if the ignition switch is turned off and the engine is restarted, Pre-Collision Throttle Management will be turned on. The default setting for Pre-Collision Throttle Management when the vehicle is restarted is "ON".

# Lane Departure Warning

When vehicle speed is approximately 30 MPH (50 km/h) or more, this function warns the driver if the system detects that the vehicle is likely to depart the traffic lane.

When Lane Departure Warning activates, a buzzer sounds 6 short beeps, and the area around the lane indicator on the departing side flashes in yellow.

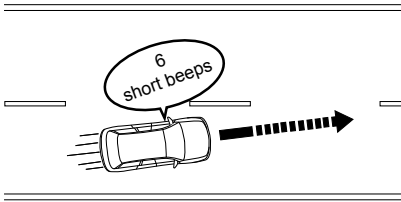

S01267

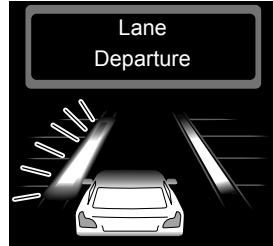

S01126

\* The illustration depicts a vehicle departing the left lane.



**WARNING**

Lane Departure Warning will not operate in all conditions. It also will not automatically return the vehicle to the original lane. If the driver relies only on the Lane Departure Warning to keep the vehicle in the lane, lane departure may occur, resulting in an accident.

The Lane Departure Warning activates when it detects lane markings. However, it is not a function which can detect the edge of a road (shoulders or side ditches, etc.) and warn the driver.

 **CAUTION**

In the following situations, the Lane Departure Warning will or may not activate:

- Vehicle speed is approximately 30 MPH (50 km/h) or less.
- When the steering wheel is turned significantly to either side
- When the vehicle is driving around a curve whose radius is 0.18 miles (300 m) or smaller.
- When the brake pedal is depressed or immediately after it is depressed
- When the accelerator pedal is almost fully depressed and the vehicle is accelerating or immediately after accelerating
- When the following distance behind a vehicle in front is short
- While the turn signal is operating and for approximately 4 seconds after the turn signal lever has returned to its original position
- For approximately 4 seconds after the hazard lamp has switched off
- When the vehicle has not returned to the inside of the lane after the Lane Departure Warning has activated
- The lane is narrow.
- When it is difficult for the camera to detect lane markings
  - There are no lane markings or they are very worn.
  - The lane markings are yellow.
  - It is difficult to detect lane markings as they are similar in color to the road surface.
  - The lane markings are narrow.

**NOTE**

- The following situations may cause incorrect lane detection and a faulty Lane Departure Warning to occur.
    - Tire tracks on a wet road or snow-covered road
    - Boundaries between snow and asphalt, marks from road repair, etc.
    - Shadows of guardrails
    - Lane markings are drawn in double
    - There are some lane markings left from roadwork or markings from the previous road.
  - When the Lane Departure Warning OFF indicator light is illuminated, the Lane Departure Warning is inactive.
- ⇒ Refer to page 62.



## Turning off Lane Departure Warning

Press and hold the Lane Departure Warning OFF switch for approximately 2 seconds or longer to turn off the Lane Departure Warning. When 1 short beep sound emits, this function is turned off and the Lane Departure Warning OFF indicator light on the instrument panel will illuminate.

To turn the function back on, press and hold the Lane Departure Warning OFF switch again for approximately 2 seconds or longer. When the function is turned on, the Lane Departure Warning OFF indicator light turns off.

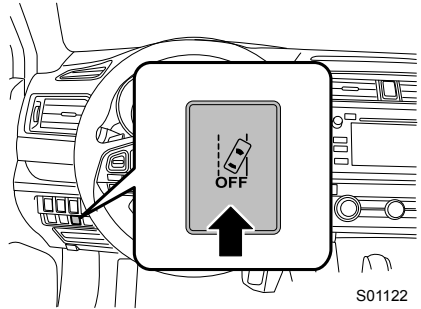

### NOTE

- When the Lane Departure Warning is turned off, the Lane Sway Warning is also turned off.
- Even when the Lane Departure Warning is turned off, if the ignition switch is turned off and then the engine is restarted, the Lane Departure Warning will be turned on. The default setting for the Lane Departure Warning when the vehicle is restarted is "ON".

## ■ Lane Departure Warning OFF indicator light

This indicator illuminates when the ignition switch is turned to the ON position, and then approximately 7 seconds after the engine starts, it turns off depending on the current status (ON or OFF). It turns off when the Lane Departure Warning is turned off.

It also illuminates under the following conditions.

- When the EyeSight system has a malfunction  
⇒ Refer to page 78.
- When the EyeSight system has stopped temporarily  
⇒ Refer to page 79.

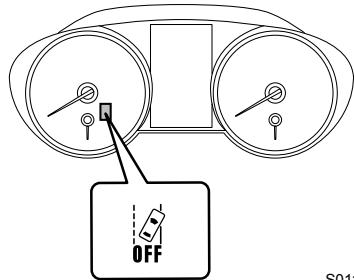

S01123

# Lane Sway Warning

This function detects wandering or drifting within a lane, and warns the driver. When Lane Sway Warning activates, a buzzer sounds 6 short beeps and the left and right lane indicators flash alternately in yellow.

This function activates only when the vehicle speed is approximately 38 MPH (60 km/h) or more.

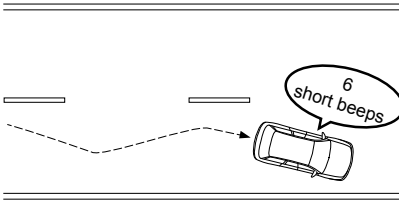

S00650



S01127

## WARNING

Lane Sway Warning will not operate in all conditions. It also will not automatically correct wandering. If the driver relies only on the Lane Sway Warning to prevent the vehicle from wandering, an accident may occur.

## CAUTION

Under the following conditions, the Lane Sway Warning may not operate.

- When driving on a winding road
- When vehicle speed changes greatly
- Immediately after a lane change
- When it is difficult for the EyeSight stereo cameras to detect lane markings
  - There are no lane markings or they are the very worn.
  - It is difficult to detect lane markings as they are similar in color to the road surface.
  - The lane markings are narrow.



**NOTE**

- Wandering detection is based on several minutes of driving data. Wandering will not be detected immediately when it occurs. In addition, the warning may continue for some time even after wandering stops.
- The Lane Sway Warning System is just a function that warns the driver. When the driver is tired, not concentrating on the road or not paying adequate attention to driving, be sure to take rest breaks as often as needed.
- When the Lane Departure Warning OFF indicator light is illuminated, the Lane Sway Warning will not operate.

⇒ Refer to page 62.

## Turning off Lane Sway Warning

Press and hold the Lane Departure Warning OFF switch for approximately 2 seconds or longer to turn off the Lane Sway Warning. When 1 short beep sound emits, this function is turned off and the Lane Departure Warning OFF indicator light on the instrument panel illuminates.

To turn the function back on, press and hold the Lane Departure Warning OFF switch again for approximately 2 seconds or longer. When the function is turned on, the Lane Departure Warning OFF indicator light turns off.

⇒ Refer to page 62.

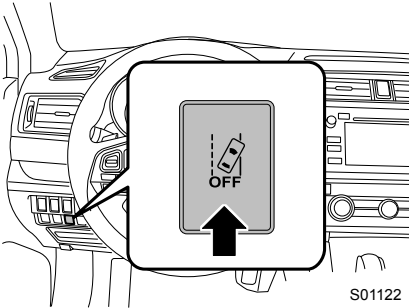

S01122

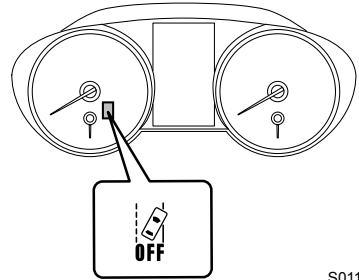

S01123



### NOTE

- When the Lane Sway Warning is turned off, the Lane Departure Warning is also turned off.
- Even when the Lane Sway Warning is turned off, if the ignition switch is turned off and then the engine is restarted, the Lane Sway Warning will be turned on. The default setting for the Lane Sway Warning when the vehicle is restarted is "ON".

# Lead Vehicle Start Alert

This function notifies the driver by means of a buzzer and the lead vehicle indicator on the multi information display when the driver's vehicle remains stopped after the vehicle in front has started to move forward. When the vehicle in front remains stopped continuously (within a following distance of approximately 32 ft (10 m) and the driver's vehicle remains stopped for several seconds or longer), the system continues to detect the vehicle in front and this alarm activates if the vehicle in front advances approximately 10 ft (3 m) or more while the driver's vehicle remains stationary.

This function only activates when the select lever is in the **D**, **M** or **N** position.

When the Lead Vehicle Start Alert activates, a buzzer sounds a two-tone beep and the lead vehicle indicator moves.

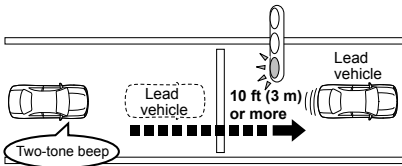

S01266

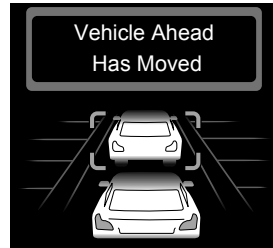

S01128



## NOTE

- The Lead Vehicle Start Alert setting can be turned on or off.  
⇒ Refer to page 81.
- Under the following conditions, the Lead Vehicle Start Alert may activate even when the vehicle in front has not started to move, or may not activate even after the vehicle in front has started to move:
  - A motorcycle or similar object has cut in between your vehicle and the stopped vehicle in front.
  - Weather or road conditions prevent detection of the vehicle in front.
  - The EyeSight stereo cameras lose detection of the vehicle in front.

# Conventional Cruise Control

## About Conventional Cruise Control

Conventional Cruise Control is a driving support system intended to allow more comfortable driving on expressways, freeways and interstate highways. It can be used to travel at a constant speed by maintaining the vehicle speed that was set by the driver. Please remember that you should not exceed posted speed limits.





### WARNING

- When Conventional Cruise Control is functioning, the system does not perform tracking control to maintain following distance, as when using Adaptive Cruise Control.  
Strive for safe driving and operate the brake pedal to decelerate the vehicle as necessary in order to ensure a safe following distance from the vehicle in front.
- Under the following conditions, do not use the Conventional Cruise Control. Doing so may result in an accident.
  - Roads with heavy traffic or roads with sharp curves  
You may fail to drive at a speed that is appropriate for the road conditions, possibly resulting in an accident.
  - Frozen roads, snow-covered roads or slippery road surfaces  
The tires may spin, causing loss of control of the vehicle.
  - Steep downhill grades  
The set vehicle speed may be exceeded.
  - On a steep continuous downhill grade  
The brakes may overheat.





### CAUTION

When using Cruise Control, be sure to check the EyeSight display area to confirm which Cruise Control mode is selected: Adaptive Cruise Control or Conventional Cruise Control.

- If Adaptive Cruise Control is selected, “” (Adaptive Cruise Control indicator) illuminates.
- If Conventional Cruise Control is selected, “” (Conventional Cruise Control indicator) illuminates.



### NOTE

- When the  (CRUISE) switch is first turned on, the Adaptive Cruise Control is set.
- To change the Cruise Control mode, press and hold the  /  (following distance setting) switch for approximately 2 seconds or longer. (This is effective only when the main Cruise Control is on and neither Adaptive Cruise Control nor Conventional Cruise Control are set.)
- Conventional Cruise Control can be used even when EyeSight is temporarily turned off.



## How to use the Conventional Cruise Control

Conventional Cruise Control can be set when the following conditions are met.

- The selector lever is in the **D** position and the paddle shift is not operated.
- The brake pedal is released.
- The vehicle speed is between approximately 25 MPH (40 km/h) and 90 MPH (145 km/h).

### ■ Setting Conventional Cruise Control

(1) Setting the Conventional Cruise Control to standby status.

Press the  (CRUISE) switch. At this time,  (Adaptive Cruise Control) and the “following distance setting” are displayed on the EyeSight display area of the multi information display. The set vehicle speed display will read “- - MPH”.

When the  (CRUISE) switch is pressed, the initial cruise control mode is always Adaptive Cruise Control.

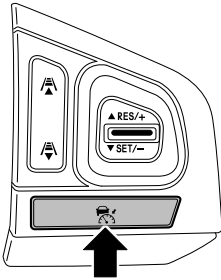

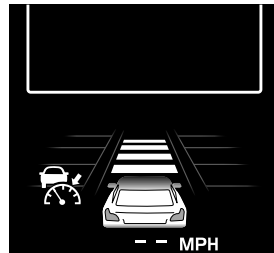

S01109



S01110

If the switch is pressed once more, the EyeSight display will turn off. It will also automatically turn off when the engine is stopped.

## (2) Switch to Conventional Cruise Control.

Press and hold the  /  (following distance setting) switch for approximately 2 seconds or longer to switch from Adaptive Cruise Control to Conventional Cruise Control. A buzzer sounds 1 short beep.

At this time, the following distance setting indicator on the EyeSight display area of the multi information display turns off and  (Conventional Cruise Control) is displayed.

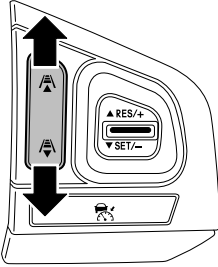

S01118

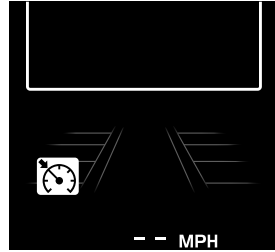

S01129

To set the ready status:

Conventional Cruise Control can be set when all of the following conditions are met and **READY** is displayed on the EyeSight display area.

- All doors (except the rear gate/trunk) are closed.
  - The driver's seatbelt is fastened.
  - The electronic parking brake is not engaged (The brake system warning light is turned off.).
  - The selector lever is in the  position, and the paddle shift is not operated.
  - The brake pedal is not depressed.
  - EyeSight operation is not temporarily stopped.
- ⇒ Refer to page 79.
- The road is not on a steep slope.
  - The steering wheel has not been turned significantly in either direction.
  - The X-mode is not turned on.
  - The vehicle speed is over approximately 25 MPH (40 km/h).

## (3) Control the accelerator pedal to reach the desired speed.



(4) When the vehicle speed is between approximately 25 MPH (40 km/h) and 90 MPH (145 km/h), press the RES/SET switch to the “SET/-”.

The vehicle speed at the time the switch is pressed becomes the set vehicle speed, and constant-speed driving is engaged.

**SET** and the set vehicle speed are displayed on the EyeSight display area.

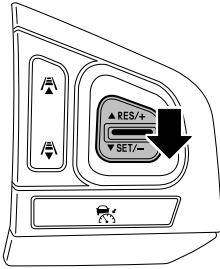

S01112

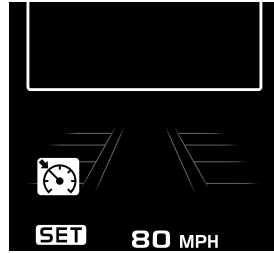

S01130



**WARNING**

The “brake more” warning will not activate while Conventional Cruise Control is functioning.





**CAUTION**

During Conventional Cruise Control use, accelerator and brake control to track the vehicle in front is not performed. Operate the accelerator and brake pedals as necessary.



**NOTE**

- On a downhill grade, automatic braking may operate in order to maintain the set vehicle speed.
- To return to Adaptive Cruise Control use, cancel the Conventional Cruise Control then press and hold the  /  (following distance setting) switch for approximately 2 seconds or longer.

## ■ Increasing the set vehicle speed

The following two methods can be used to increase the set vehicle speed.

### ● Using the RES/SET switch

Push the RES/SET switch in the following way while you are driving with Conventional Cruise Control on:

- Push the RES/+ switch towards the position (1) briefly: the set vehicle speed will increase in increments of 1 MPH (1 km/h) every time the button is pushed.
- Push the RES/+ switch towards the position (1) for longer: the set vehicle speed will increase in increments of 1 MPH (1 km/h) while the button is being pushed.
- Push the RES/+ switch towards the position (2) briefly: the set vehicle speed will increase in increments of 5 MPH (5 km/h) every time the button is pushed.
- Push the RES/+ switch towards the position (2) for longer: the set vehicle speed will increase in increments of 5 MPH (5 km/h) while the button is being pushed.

The set vehicle speed is shown on the EyeSight display area.

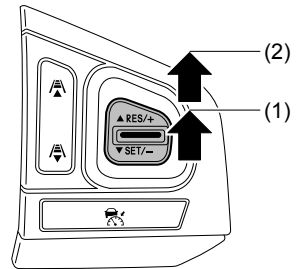

S01115

### ● Using the accelerator pedal

Operate the accelerator pedal to increase the vehicle speed.

When the desired speed is reached, press the RES/SET switch to the "SET/-". When the switch is released, the new vehicle speed is set.

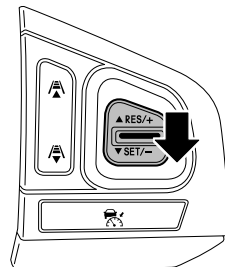

S01112

## ■ Decreasing the set vehicle speed

### ● Using the RES/SET switch

Push the RES/SET switch in the following way while you are driving with Conventional Cruise Control on:

- Push the SET/- switch towards the position (1) briefly: the set vehicle speed will decrease in increments of 1 MPH (1 km/h) every time the button is pushed.
- Push the SET/- switch towards the position (1) for longer: the set vehicle speed will decrease in increments of 1 MPH (1 km/h) while the button is being pushed.
- Push the SET/- switch towards the position (2) briefly: the set vehicle speed will decrease in increments of 5 MPH (5 km/h) every time the button is pushed.
- Push the SET/- switch towards the position (2) for longer: the set vehicle speed will decrease in increments of 5 MPH (5 km/h) while the button is being pushed.

The set vehicle speed is shown on the EyeSight display area.

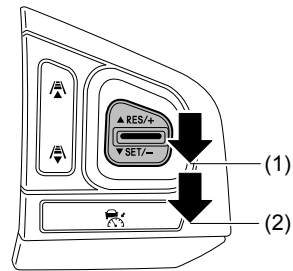

S01116

### ● Using the brake pedal

- (1) Depress the brake pedal to decrease the vehicle speed. (Conventional Cruise Control will be canceled and **SET** will be turned off.)
- (2) When the desired speed is reached, press the RES/SET switch to the "SET/-". The speed at the time of pressing the switch will be set as the new vehicle speed, and it appears in the EyeSight display area.

## ■ Accelerating temporarily

Depress the accelerator pedal to accelerate temporarily.

When the accelerator pedal is released, the vehicle returns to the set vehicle speed.

## ■ Decelerating temporarily

Depress the brake pedal to decelerate temporarily. When the brake pedal is depressed, Conventional Cruise Control will be canceled. While the set vehicle target speed remains displayed on the EyeSight display area, **SET** will be turned off.

Release the brake pedal and press the RES/SET switch for “RES/+” to reset the set vehicle target speed.

**SET** will be turned off.

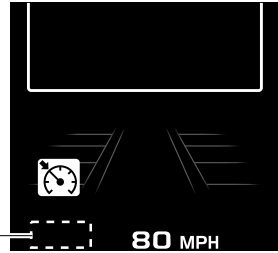

S01131

## ■ Canceling Conventional Cruise Control

### ● Manual Cancellation by the driver



Any of the following operations will cancel Conventional Cruise Control.

- Depress the brake pedal.

**SET** will be turned off while the set vehicle target speed remains displayed on the EyeSight display area.

- Press the  (CRUISE) switch.

**SET** will be turned off while the set vehicle target speed remains displayed on the EyeSight display area.

When the  (CRUISE) switch is pressed again, the  will be turned off and Conventional Cruise Control will be turned off.

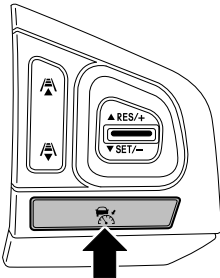

S01109

**SET** will be turned off.

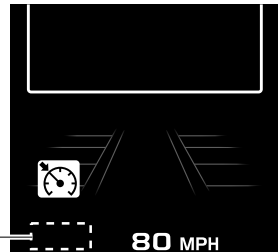

S01131

## ● Automatic cancellation by the system

In the following cases, a buzzer sounds a single long beep and the Cruise control function is automatically canceled (**OFF** is displayed on the Eye Sight display area.). After the conditions listed below have been eliminated, perform the cruise control set operation again to reactivate cruise control.

- The select lever was moved to a position other than **D**.  
The cruise control function can be used again after the lever is returned to the **D** position.
- A paddle shift switch was operated during driving with the lever in the **D** position.  
The cruise control function can be used again after the shift indicator returns to **D**.
- Vehicle speed drops to approximately 20 MPH (30 km/h) or less (due to a steep uphill grade or some other reason).

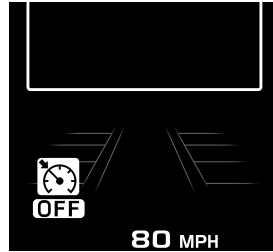

S01132

- The X-mode is turned on (the X-mode indicator light  illuminates).
  - Cruise control can be resumed after the X-mode is turned off.
- Vehicle speed rises to approximately 100 MPH (160 km/h) or more (due to a steep downhill grade or some other reason).
- The ABS, Vehicle Dynamics Control or Traction Control functions activate.
- Any door (except the rear gate/trunk) was opened.
- The driver's seatbelt is unfastened.
- The Electronic Parking Brake is engaged (When the brake system warning light is illuminated or flashing).
- EyeSight is malfunctioning. (Refer to page 78, "EyeSight malfunction and temporary stop".)
- The steering wheel is turned significantly in either direction.
- The grade of the road is steep.
- The Pre-Collision secondary braking has activated.



### WARNING

Do not use Conventional Cruise Control on slippery roads. Doing so may result in an accident.

 **CAUTION**

When shifting the selector lever to the **[N]** position, Adaptive Cruise Control will be automatically canceled. Do not shift the lever to the **[N]** position unless it is an emergency. Otherwise the engine brake may not operate, which could cause an accident.

 **NOTE**

- If EyeSight is malfunctioning, the EyeSight warning indicator is displayed on the multi information display and the Pre-Collision Braking System OFF indicator light and Lane Departure Warning OFF indicator light illuminate. If this occurs, stop the vehicle in a safe location and then stop the engine and restart it. If the indicators remain illuminated after restarting the engine, Conventional Cruise Control cannot be used. This will not interfere with ordinary driving; however the system should be inspected by a SUBARU dealer as soon as possible.

⇒ Refer to page 78.

- When operation of Conventional Cruise Control has been automatically canceled, perform the set operation again after the condition that caused the cancellation has been eliminated. If cruise control cannot be set even after the condition has been corrected, EyeSight may be malfunctioning. This will not interfere with ordinary driving; however the system should be inspected by a SUBARU dealer as soon as possible.

## ■ Resuming a vehicle speed that was previously stored

A vehicle speed that has been previously set is stored in memory\*. To recall and set that vehicle speed, press the RES/SET switch to the "RES/+". (The EyeSight display area shows the set condition again.)

Resume is possible when a vehicle speed was previously set, and the current vehicle speed is approximately 20 MPH (30 km/h) or more.

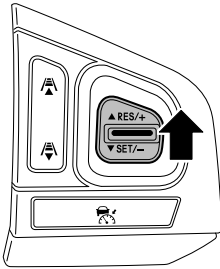

S01133

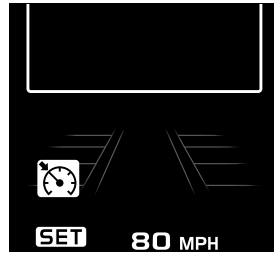

S01130



### NOTE

- \* The vehicle speed stored in memory is erased at the following times:
  - The cruise control is turned off by pressing the  (CRUISE) switch.
  - Either vehicle Dynamics Control or Traction Control Function has been activated.
  - The cruise control mode was switched from Conventional Cruise Control to Adaptive Cruise Control.
- The vehicle will drive at a constant speed that was set between approximately 25 MPH (40 km/h) and 90 MPH (145 km/h).
- If there is no vehicle speed in the memory (a previously set vehicle speed), the vehicle speed cannot be resumed by depressing the RES/+ switch.

# List of buzzer sounds

| Buzzer sound                         | Status  | Reference page              |
|--------------------------------------|---|-----------------------------|
| Single continuous beep               | Pre-Collision Braking System:<br>Secondary Braking is active.   | ⇒ Refer to page 27.         |
| Single long beep                     | Adaptive Cruise Control or Conventional Cruise Control is canceled.   | ⇒ Refer to pages 49 and 74. |
|                                      | The Electronic Parking Brake was automatically applied during stay-stopped condition by Adaptive Cruise Control.  |                             |
| Repeated short beeps                 | Pre-Collision Braking System:<br>First Braking is active.   | ⇒ Refer to page 27.         |
|                                      | Pre-Collision Braking System:<br>The following distance warning is active.  | ⇒ Refer to page 52.         |
|                                      | The "brake more" warning from Adaptive Cruise Control is active.  |                             |
|                                      | Pre-Collision Throttle Management is active.  | ⇒ Refer to page 54.         |
| 6 short beeps                        | The Lane Departure Warning is active.   | ⇒ Refer to page 60.         |
|                                      | The Lane Sway Warning is active.  | ⇒ Refer to page 63.         |
| 5 intermittent beeps and 1 long beep | The stay-stopped function of Adaptive Cruise Control continued for 2 minutes and the Electronic Parking Brake is automatically applied.                       | ⇒ Refer to page 47.         |
| 1 short beep                         | Either of the following occurred while Adaptive Cruise Control was set.<br>- A vehicle in front is detected*.<br>- A vehicle in front is no longer detected*. | ⇒ Refer to page 40.         |
|                                      | The cruise control mode (Adaptive Cruise Control ↔ Conventional Cruise Control) is changed.   | ⇒ Refer to page 69.         |
|                                      | EyeSight is malfunctioning.   | ⇒ Refer to pages 78 and 79. |
|                                      | EyeSight operation is temporarily stopped.  |                             |
|                                      | Pre-Collision Braking System and Pre-Collision Throttle Management are turned on/off.   | ⇒ Refer to pages 30 and 59. |
|                                      | The Lane Departure Warning and the Lane Sway Warning are turned on/off.   | ⇒ Refer to pages 62 and 65. |
| Two-tone beep                        | Lead Vehicle Start Alert is active*.  | ⇒ Refer to page 66.         |

\*The buzzer that indicates when a lead vehicle is detected or when it is no longer detected (Lead Vehicle Acquisition Sound), as well as the Lead Vehicle Start Alert can be turned on or off.

⇒ Refer to page 81.



# EyeSight malfunction and temporary stop

If a malfunction is detected in the EyeSight system, the indicators in the instrument panel and the multi information display inform the driver of the malfunction. Check the displayed contents and take the appropriate action.

## ■ Malfunction (including position/angle misalignment of stereo cameras)

The buzzer sounds 1 short beep and the EyeSight warning indicator  (yellow) flashes or illuminates. At the same time, the Pre-Collision Braking System OFF indicator light and the Lane Departure Warning OFF indicator light will illuminate. A message will also be displayed on the multi information display.

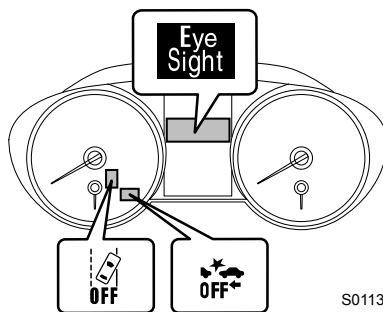

S01134

| Displayed screen   | Cause  | Action   |
|--|--|--|
|  <p>S00699</p> | An EyeSight malfunction or position/angle misalignment of stereo cameras has occurred. | Inspection and adjustment is necessary.<br>Contact your SUBARU dealer. |

### CAUTION

If both the EyeSight warning indicator and the CHECK ENGINE warning light/malfunction indicator light illuminate at the same time while driving, have your vehicle checked/repared by a SUBARU dealer as soon as possible. EyeSight cannot be used if there is an abnormality with the engine, etc.

### NOTE

- If the EyeSight warning indicator illuminated or flashed, stop the vehicle in a safe location, and after stopping the engine once by turning off the engine switch, restart the engine.
- If the indicator continues illuminating or flashing even after the engine has been restarted, the EyeSight system has a malfunction. In this case, all EyeSight functions will be stopped. Normal driving will still be possible. However, contact a SUBARU dealer for an inspection.

## ■ Temporary stop



The buzzer will sound one short beep, and the EyeSight temporary stop indicator  (white), Pre-Collision Braking System OFF indicator light and Lane Departure Warning OFF indicator light will illuminate at the same time.

A message will also be displayed on the multi information display.

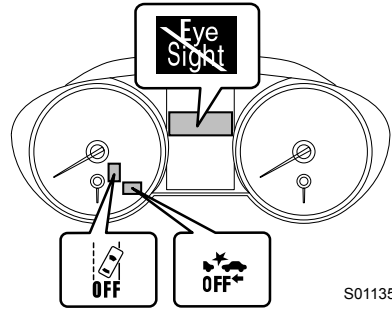
When the cause has been eliminated, temporary stop will be canceled and the EyeSight system will automatically restart.

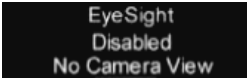

S01135

| Displayed screen  | Cause   | Action   |
|---|---|--|
|  <p>S00700</p>   | <p>It is difficult for the stereo cameras to detect objects in front</p> <ul style="list-style-type: none"> <li>• The front windshield is dirty or fogged up</li> <li>• Poor weather conditions</li> <li>• Strong light from the front</li> </ul> | <ul style="list-style-type: none"> <li>• Clean the front windshield.</li> <li>• In bad weather or if there is strong light from the front, the EyeSight system will restart once you have driven your vehicle for a period of time and the conditions affecting the system have improved. If the system does not restart, even after the conditions have improved and a period of time has elapsed, contact your SUBARU dealer for an inspection.</li> </ul> |
|  <p>S00701</p> | <p>In low or high temperatures</p>  | <p>The system will restart once the temperature is within the operational range of the EyeSight system. If the system does not restart, even when the temperature inside the vehicle is normal, contact your SUBARU dealer for an inspection.</p>  |

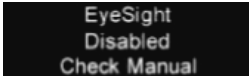
| Displayed screen  | Cause   | Action  |
|---|---|---|
|  <p>EyeSight<br/>Disabled<br/>Check Manual<br/>S00694</p> | <ul style="list-style-type: none"> <li>• When the EyeSight system is starting</li> <li>• When the system has determined that the vehicle is extremely inclined</li> <li>• When the pre-collision secondary braking has operated 3 times after the engine was started</li> <li>• When the engine is stopped</li> </ul> | <p>The system will restart once the cause has been eliminated. At this time, it may take some time for the system to restart. If the system does not restart, even after the conditions have improved and a period of time has elapsed, contact your SUBARU dealer for an inspection.</p> |



**NOTE**

When the EyeSight temporary stop indicator has illuminated, no EyeSight functions can be used except for Conventional Cruise Control.

# Customizing functions

The following settings can be changed on the multi information display.

|          | Item                                 | Setting     | Default setting |
|----------|--------------------------------------|-------------|-----------------|
| EyeSight | Warning Volume                       | Max/Mid/Min | Mid             |
|          | Lead Vehicle Acquisition Sound       | ON/OFF      | ON              |
|          | Lead Vehicle Moving Monitor Function | ON/OFF      | ON              |
|          | Vehicle Icon                         | ON/OFF      | ON              |



## NOTE

The following settings can be restored to the factory (default) settings.  
⇒ Refer to the Owner's Manual for your vehicle.

## ■ How to customize

Operations can be performed when the selector lever is in the **P** position and the ignition switch is in the ON position while the vehicle is parked.

- (1) Pull the ▲ / ▼ switch toward you to display the “Change settings” screen.  
Keep pulling the **i** (Info)/SET switch to change to the settings screen.

- (2) Pull the ▲ / ▼ switch toward you, select “EyeSight”, and pull the **i** (Info)/SET switch to confirm.

The system will then switch to the EyeSight settings screen.

Operate the following switches according to what is displayed on the screen.

- Select: ▲ (Return) switch / ▼ (Send) switch
- Confirm: **i** (Info)/SET switch

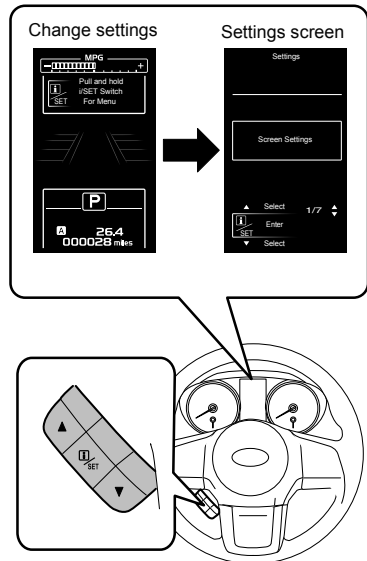

S01136

● **Warning Volume setting**

The volume can be set to Max/Mid/Min.

When on the Warning Volume settings screen, if the volume is selected with the ▲ / ▼ switch, 3 short beeps will sound.

● **Lead Vehicle Acquisition Sound setting**

The Lead Vehicle Acquisition Sound setting can be activated (ON) or deactivated (OFF).

● **Lead Vehicle Moving Monitor Function**

The Lead Vehicle Start Alert function setting can be activated (ON) or deactivated (OFF).

● **Vehicle Icon setting**

Your vehicle indicator setting can be activated (ON) or deactivated (OFF).



**NOTE**

When "Return" is selected, the system will return to the screen directly above the current one.

● **Cancelling the custom functions**

In the following cases, the custom functions will be canceled and the "Change settings" screen will be displayed.

- When you keep pulling the **i** (Info)/SET switch toward you
- When the engine switch is turned off
- When the switch is not operated for approximately 30 seconds

# Message screen list

If an EyeSight warning or malfunction is detected, a message will be displayed on the multi information display. Depending on the message, a buzzer will sound at the same time.

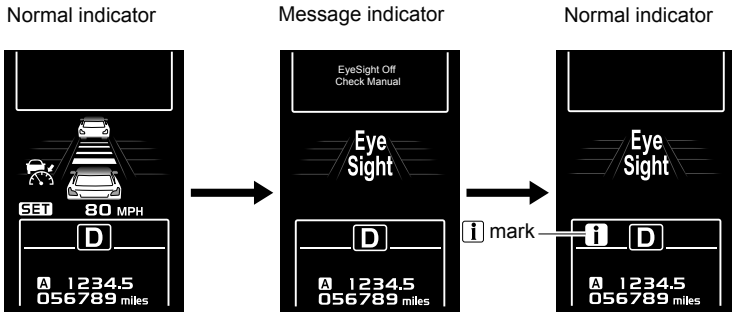

S01137

If a message is displayed, refer to the message list and take the appropriate action. While the **i** mark is illuminated, pull the **i** (Info)/SET switch to indicate the message again.

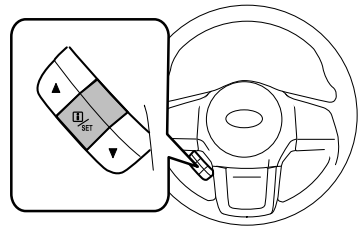



S01138

## ■ Message screen list (precautions and notices)

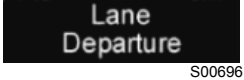
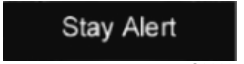
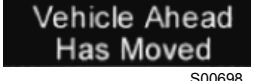
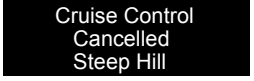



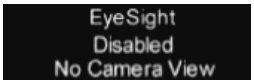

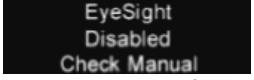



| Item                              | Displayed screen                              | <b>i</b> mark | Action              |
|-----------------------------------|---|---------------|---------------------|
| Pre-Collision Braking System      |   | None          | ⇒ Refer to page 27. |
| The “brake more” warning          | <b>Obstacle Detected</b>                      | None          | ⇒ Refer to page 52. |
| Pre-Collision Throttle Management | S00695  | None          | ⇒ Refer to page 54. |
| Apply Brake                       | <b>Apply Brake To Hold Position</b><br>S01139 | None          | ⇒ Refer to page 27. |

| Item   | Displayed screen  | <b>i</b> mark | Action                      |
|--|---|---------------|-----------------------------|
| Lane Departure Warning   | <br>S00696 | None          | ⇒ Refer to page 60.         |
| Lane Sway Warning  | <br>S00697 | None          | ⇒ Refer to page 63.         |
| Lead Vehicle Start Alert   | <br>S00698 | None          | ⇒ Refer to page 66.         |
| Adaptive Cruise Control/Conventional Cruise Control automatic cancellation | <br>S01139 | None          | ⇒ Refer to pages 49 and 74. |









■ Message screen list (malfunction, temporary stop)



| Item                           | Displayed screen  | <b>i</b> mark | Action              |
|--------------------------------|---|---------------|---------------------|
| EyeSight System Malfunction    | <br>S00699  | Yes (yellow)  | ⇒ Refer to page 78. |
| EyeSight system temporary stop | <br>S00700 | Yes (white)   | ⇒ Refer to page 79. |
|                                | <br>S00701 | Yes (white)   | ⇒ Refer to page 79. |
|                                | <br>S00694 | Yes (white)   | ⇒ Refer to page 80. |



# Troubleshooting















|  |   |
|--|---|
|  | <p>Adaptive Cruise control cannot be set.</p>   |
|  | <p>Did you remember to press the  (CRUISE) switch?<br/>If you have not pressed the  (CRUISE) switch,  (Adaptive Cruise Control) will not be shown.</p>   |
|  | <p>Is EyeSight operation temporarily stopped?<br/>When EyeSight is temporarily stopped,  is displayed on the multi information display.<br/>Set cruise control again after the reason for the temporary stop has been corrected.</p>   |
|  | <p>Is <b>READY</b> displayed?<br/>Cruise control cannot be set when <b>READY</b> is not displayed. Set cruise control when <b>READY</b> is displayed.</p>   |
|  | <p><b>READY</b> is not displayed.</p>   |
|  | <p>Are the requirements for setting cruise control met?<br/>In any of the following cases, <b>READY</b> will not be displayed.</p> <ul style="list-style-type: none"> <li>• The brake pedal is depressed.</li> <li>• The vehicle speed is over 90 MPH (145 km/h).</li> <li>• The combination meter indicates a position other than <b>D</b>. (The select lever or paddle shift switches are manually operated.)</li> <li>• The driver's seatbelt is unfastened.</li> <li>• Any door is opened (except the rear gate/trunk).</li> <li>• The electronic parking brake is applied (The brake system warning light is illuminated or flashing.)</li> <li>• The vehicle is on a steep grade.</li> <li>• The X-mode is turned on. (The X-mode indicator illuminates.)</li> <li>• The steering wheel is turned significantly in either direction.</li> </ul> <p>*For details of how to release the Electronic Parking Brake, refer to the Owner's Manual for your vehicle.</p> |









|  |  |
|--|--|
|  | <p>A vehicle (in front of your vehicle) is not detected, is detected later or detection is lost quickly.</p>   |
|  | <p>Is the vehicle in front stopped, moving slowly relative to your vehicle or moving extremely slowly?<br/>Detection of stopped vehicles, vehicle moving slowly relative to your vehicle, and vehicles moving extremely slowly may be difficult.</p> |
|  | <p>Is the windshield dirty or fogged?<br/>If the windshield is dirty or fogged, it may not be possible to detect object or vehicles. Clean off the dirt or fog from the windshield, and then try using the system again.</p>                         |
|  | <p>Is the vehicle in front far away?<br/>The maximum detection distance of EyeSight's stereo cameras is approximately 360 ft (110 m). Detection is not possible if the vehicle is farther away.</p>  |
|  | <p>Is the vehicle on a curve?<br/>The detection range is limited in the left and right directions when the cameras are properly aimed.</p>   |
|  | <p>Is the vehicle on a road with repeated uphill and downhill grades (such as an overpass), or on a banked road?<br/>The detection range is limited in the up and down directions.</p>   |
|  | <p>Did the vehicle detected in front change?<br/>Detection may be delayed after the vehicle in front has changed.</p>  |
|  | <p>Have water, snow or other substances been kicked up by the vehicle in front as it drives?<br/>When water or snow have been kicked up, it may not be possible to detect the vehicle in front.</p>  |

|  |   |
|--|---|
|   | <p>Control is activated even though no vehicle in front is detected?</p>  |
|  | <p>Is there a vehicle in the neighboring lane?<br/>Depending on the road conditions, vehicles in neighboring lanes may be detected as well as a vehicle directly in front.</p>                |
|  | <p>Are you driving on or near a curve?<br/>When driving on a curve, braking control may be activated in response to guard rails, the angle of the steering wheel, or roadside structures.</p> |

|  |  |
|--|--|
|  | <p>The Lead Vehicle Start Alert activates, even though there is no vehicle in front.</p>   |
|  | <p>Depending on surrounding objects, traffic environment and weather, the Lead Vehicle Start Alert may issue a warning in response to objects other than a vehicle that appear in front of your vehicle.</p> |

|   |   |
|---|---|
|     | <p>EyeSight does not restart after a temporary stop.</p>  |
|    | <p>Is the X-mode turned on?<br/>EyeSight cannot be activated when the X-mode is turned on.</p>  |
|    | <p>Are you driving in the rain with old wipers or is there an oily film on the windshield?<br/>Replace the wipers with new ones, or clean the oily film off the windshield.<br/>Are you driving in poor weather conditions with heavy rain, snow, fog, or dust? In these cases, EyeSight may temporarily stop operating while visibility is very low.</p>   |
|    | <p>Is your vehicle subject to sunlight from the front (sunset or sunrise, etc.) or to bright headlights from oncoming vehicles at nighttime?<br/>In these cases, EyeSight may temporarily stop operating.</p>   |
|     | <p>The timing of the “brake more” warning is sometimes earlier and sometimes later than what seems to be normal operation.</p>  |
|    | <p>The “brake more” warning sounds when the system determines that more braking is necessary, based on conditions such as the distance from the vehicle in front and the difference in speed compared to it. As a result, timing may vary depending on how the brakes are applied in relation to the vehicle in front, and your relative speed to that vehicle.</p>   |
|     | <p>When the vehicle in front has turned off the road away or the distance from the vehicle in front has increased, acceleration is sometimes slower or faster.</p>  |
|    | <p>Depending on the timing of when the detection of the vehicle in front is lost, EyeSight’s ability to react may be slower, causing the start of acceleration to feel delayed and braking time to feel longer than what seems to be normal operation.</p>  |
|   | <p>Cruise control is canceled automatically.</p>  |
|  | <p>Did you perform one of the following operations?</p> <ul style="list-style-type: none"> <li>• Manually depressing the brake pedal</li> <li>• Pressing the  (CRUISE) switch             <ul style="list-style-type: none"> <li>- If the  (CRUISE) switch is pressed while the cruise control is set, the cruise control will be canceled.</li> </ul> </li> <li>• Staying on a steep slope</li> <li>• Turning the steering wheel sharply</li> <li>• Operating the paddle shift lever</li> <li>• Shifting the selector lever to the  position</li> <li>• Pressing the X-mode switch (The X-mode indicator illuminates.)</li> </ul> |
|  | <p>Has the EyeSight system temporarily stopped?</p>   |

|  |   |
|--|---|
|  | <p>A noise occurs when automatic braking control activates.</p>   |
|  | <p>This is the sound of the automatic braking control operating - there are some mechanical components to the system, and they do occasionally make audible sounds during automatic braking control. It is not necessarily a malfunction.</p>   |
|  | <p>Braking control activates frequently when driving in heavy traffic.</p>  |
|  | <p>Unlike a human driving, the EyeSight system performs control based only on the actions of vehicles or objects in front. As a result, acceleration and deceleration may be more frequent while the system adjusts to vehicles or objects the camera system is detecting. If it is difficult to maintain a consistent following distance under certain conditions (like in bad weather or urban environments, etc.), do not use Adaptive Cruise Control.</p> |
|  | <p>The Electronic Parking Brake is applied automatically while the stay-stopped function is operating.</p>  |
|  | <p>The electronic parking brake will be applied in the following cases.</p> <ul style="list-style-type: none"> <li>• The stay-stopped function is continuously applied for approximately 2 minutes.</li> <li>• Automatic cancel conditions (⇒ refer to page 49.) have been met.</li> </ul>  |

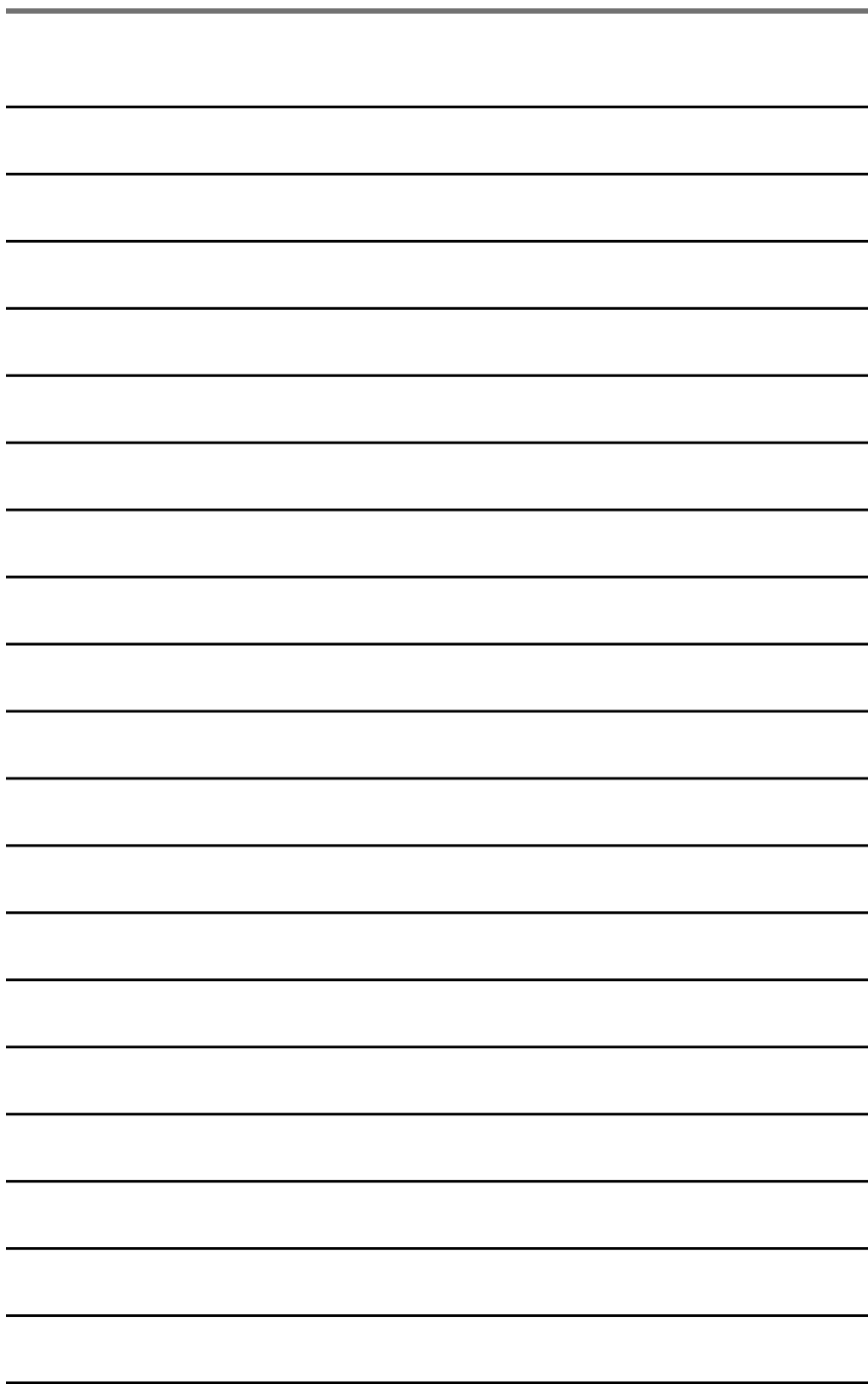

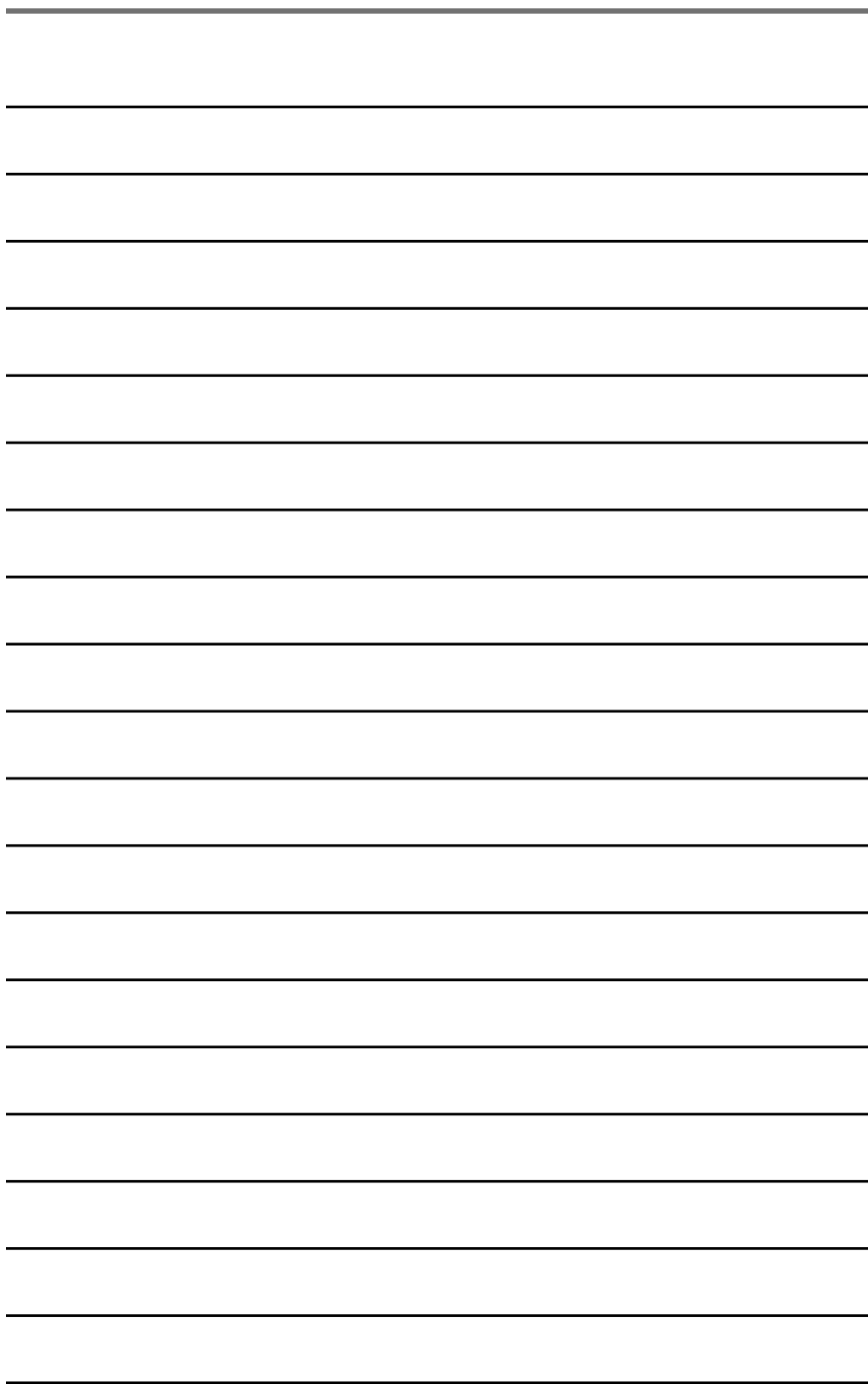

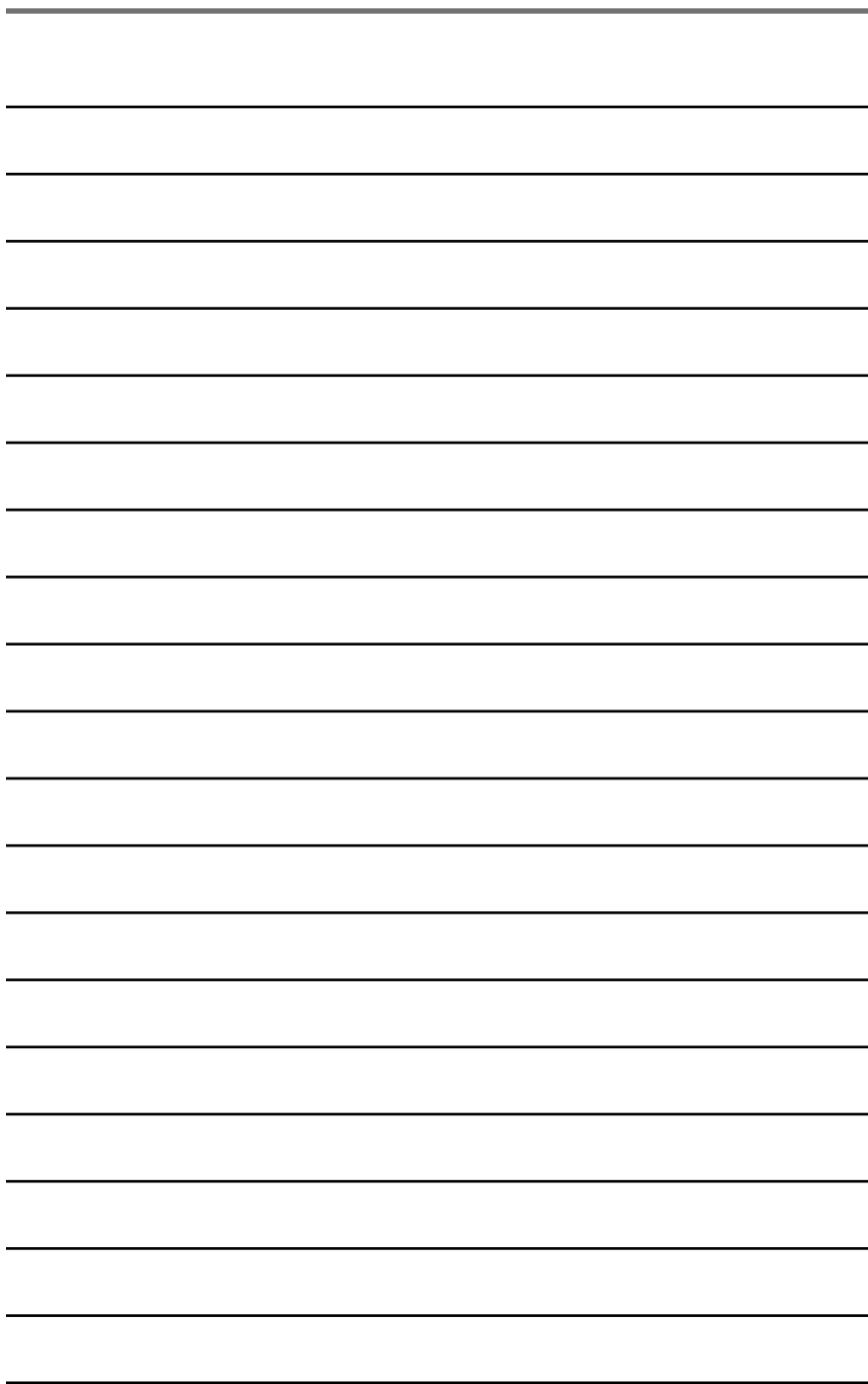

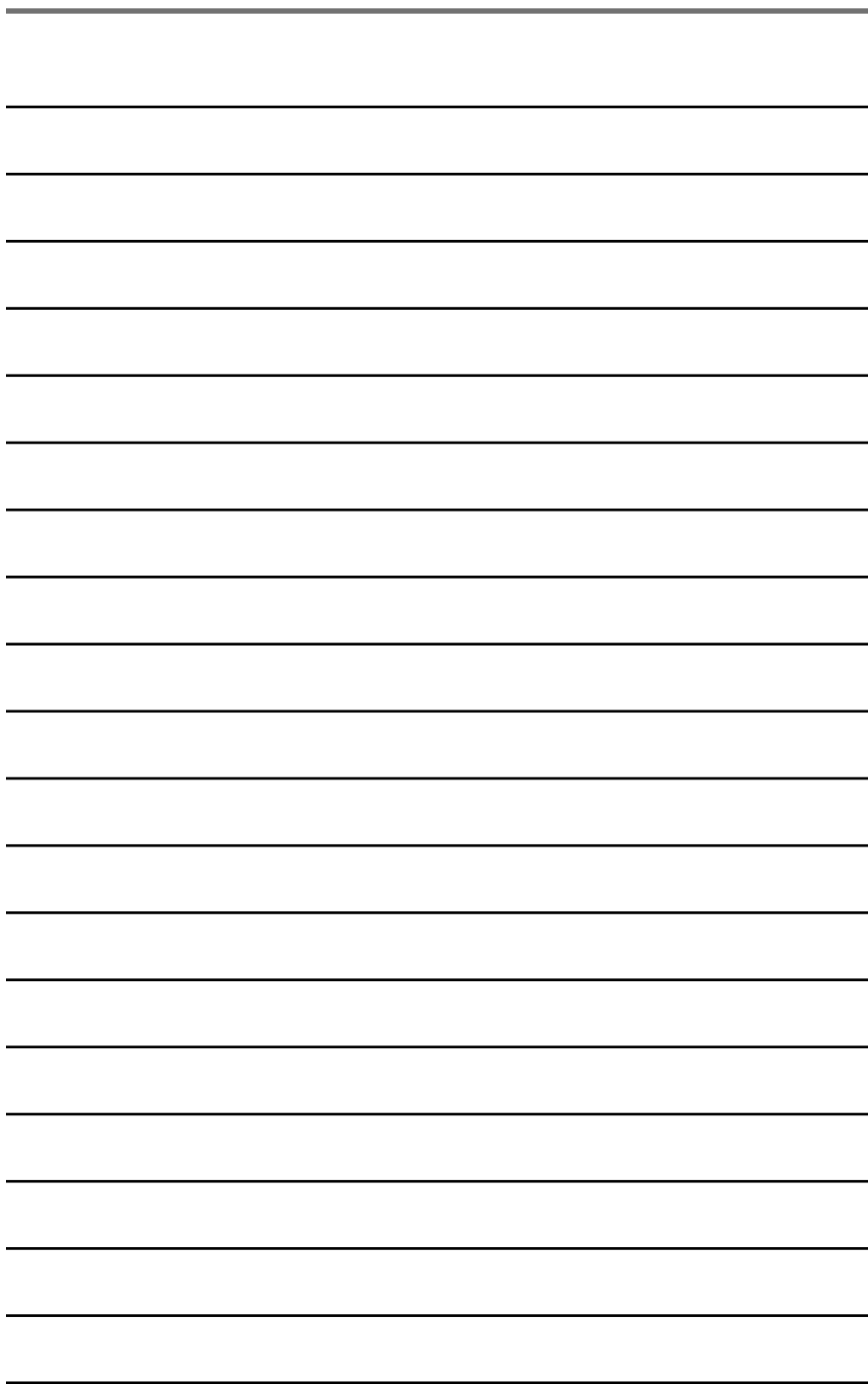

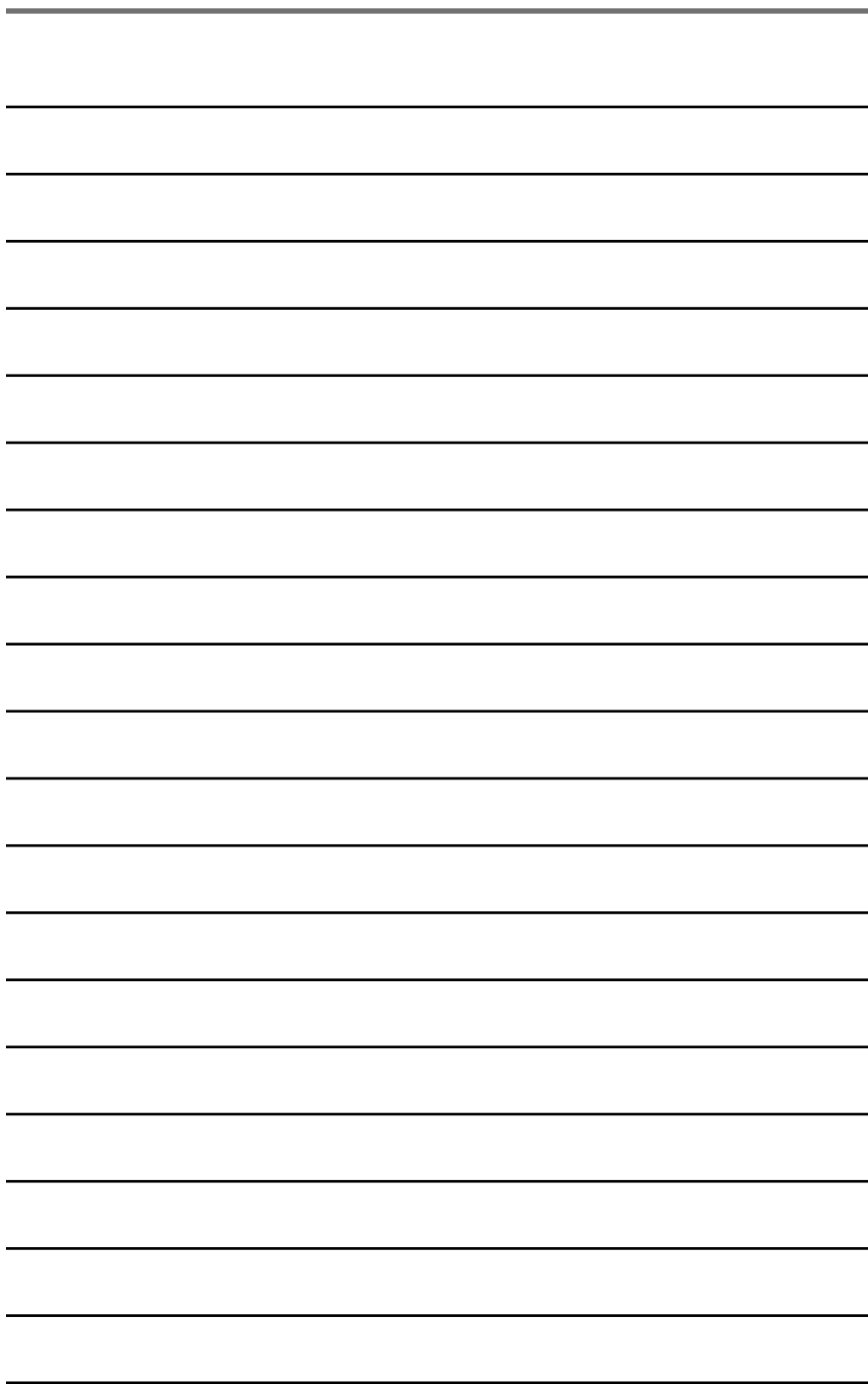



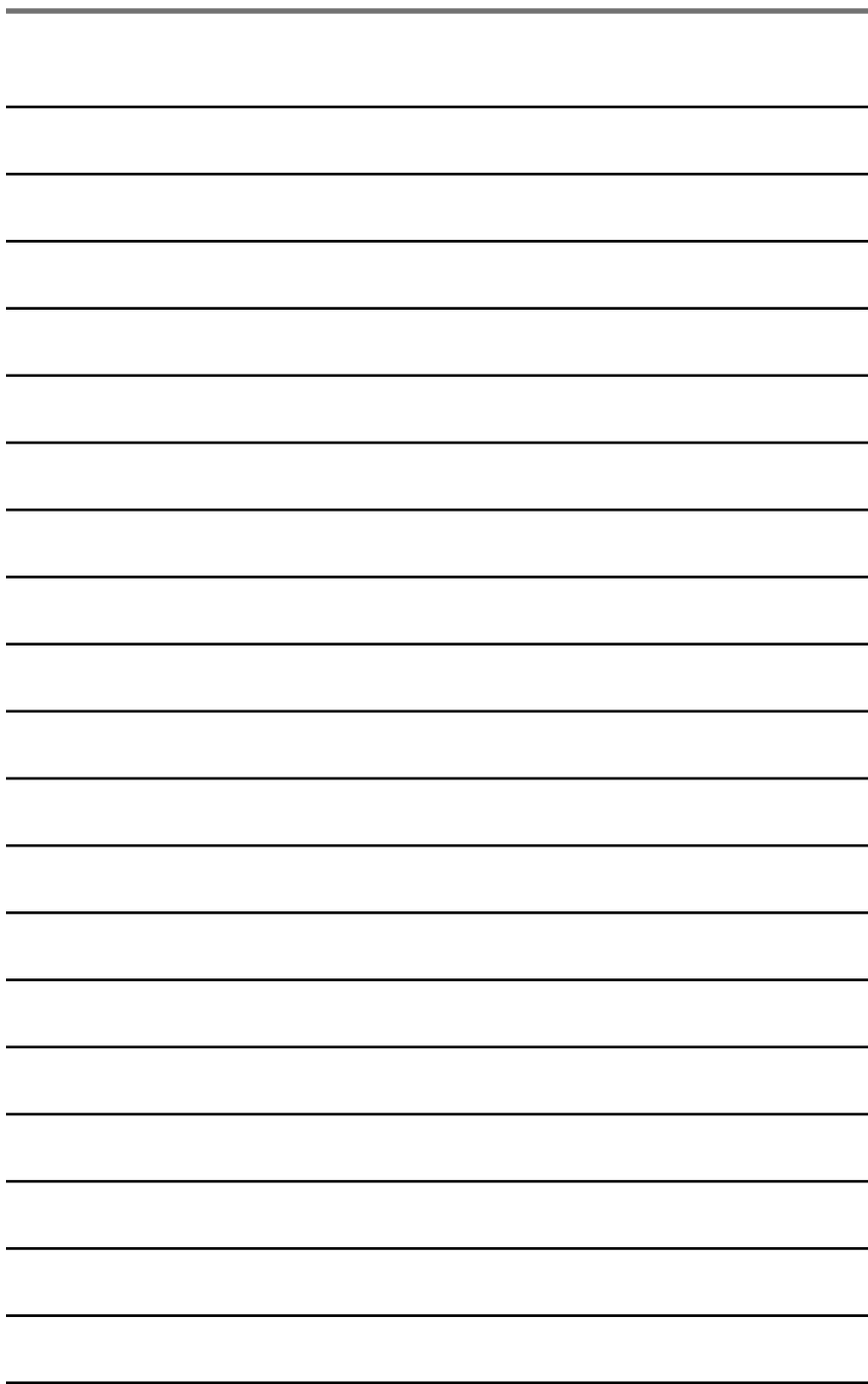



MSA5M1518A  
B2512BE-B  
Issued July 2014  
Printed in USA 07/14  
2015B



FUJI HEAVY INDUSTRIES LTD.  
TOKYO, JAPAN

英語