

# LEGACY

## 2015 Quick Reference Guide



**SUBARU**

*Confidence in Motion*



**For detailed operating and safety information, please refer to your Owner's Manual.**

## BASIC OPERATION

### Lock/ Unlock doors

#### Remote keyless entry system

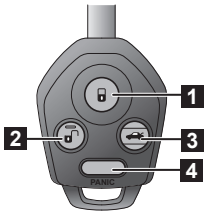

Remote transmitter key (if equipped)

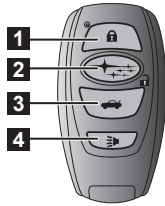

Access key (if equipped)

- 1 All doors will be locked.
- 2 The driver's door will be unlocked. (To unlock all doors, briefly press the button a second time within 5 seconds.)
- 3 Press and hold to open the trunk.
- 4 The horn will sound and the hazard warning flashes will flash.

#### Keyless access function (if equipped)

All doors will be locked/unlocked by the following procedures carrying the access key on your person. (The driver should always carry the access key.)

##### Side door (front door handles only):

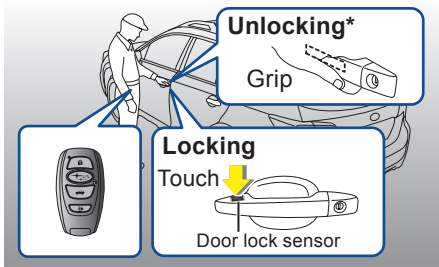

\*Grip the driver's door handle to unlock the driver's door. Grip the front passenger's door handle to unlock all doors.

##### Opening Trunk:

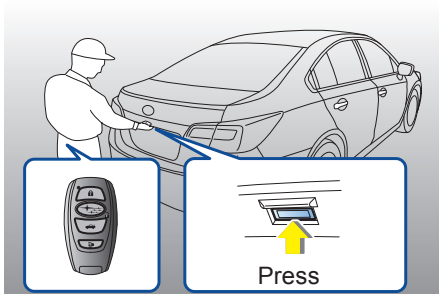

## Adjustable components

### Front seat

Power seat (Driver's seat-if equipped):

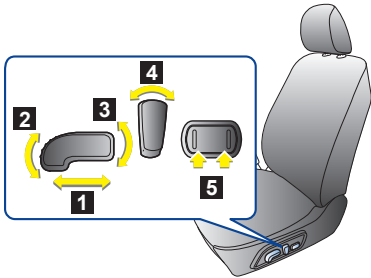

- 1 Forward and backward adjustment
- 2 Seat cushion angle adjustment
- 3 Seat height adjustment
- 4 Seatback angle (reclining) adjustment
- 5 Lumber support adjustment

Manual seat (if equipped):

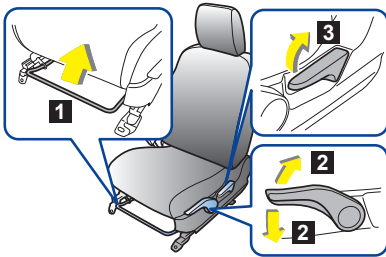

- 1 Forward and backward adjustment
- 2 Seat cushion height adjustment (Driver's seat only)
- 3 Seatback reclining adjustment

### Tilt/ telescopic steering wheel

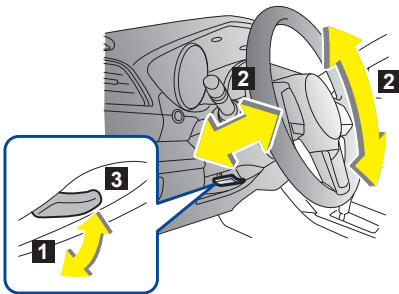

- 1 Adjust the seat position and pull the tilt/telescopic lock lever down.
- 2 Move the steering wheel to the desired level.
- 3 Pull the lever up to lock the steering wheel in place.

Make sure that the steering wheel is securely locked by moving it up and down, and forward and backward.

### Remote control mirror switch

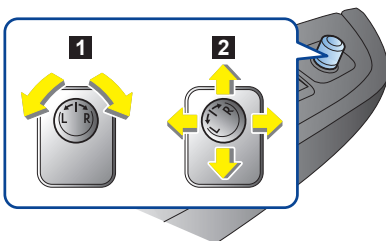

Ignition switch must be in **ACC** or **ON** position.

- 1 Select side to adjust
- 2 To adjust the mirror, move the switch in the direction of your desired position.

## Start/ Stop engine

### Push-button ignition switch (if equipped)

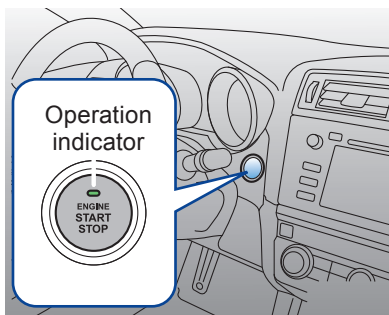

#### Starting engine:

1. Carry the access key, and sit in the driver's seat.
2. Apply the parking brake.
3. Shift the select lever in the **P** position (CVT models) or shift lever in neutral (MT models).
4. Depress the brake pedal (CVT models) or brake pedal and clutch pedal (MT models) until the indicator on the push-button ignition switch turns green.
5. While depressing the brake pedal (CVT models) or clutch pedal (MT models), press the push-button ignition switch.

#### To stop engine:

1. Stop the vehicle completely.
2. Move the select lever to the **P** position (CVT models) or shift lever in neutral (MT models).
3. Press the push-button ignition switch.

Every time the button is pressed without depressing the brake pedal, the power is switched in the sequence of **OFF**→**ACC**→**ON**→**OFF**.

**OFF** (Turned off)



**ACC** (Orange)



**ON** (Orange)



### Electronic parking brake switch

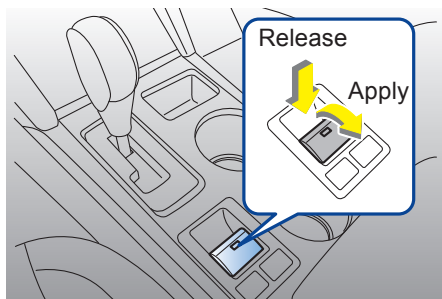

\*The design may be slightly different from the illustration depending on the models.

### Ignition switch (if equipped)



The key can be turned from **ACC** to **LOCK** only when the key is pushed in while turning it (all models) and the select lever is in the **P** position (CVT models).

## Operate Select lever/ Shift lever

### Continuously variable transmission (if equipped)

Select lever button

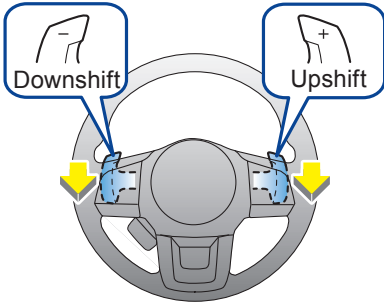
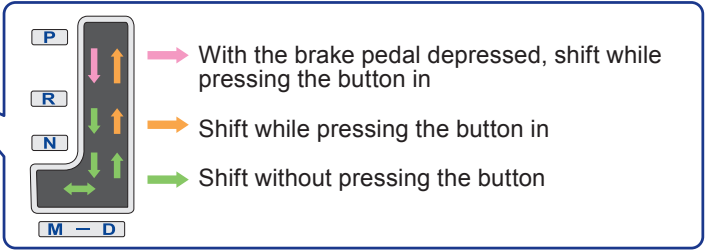
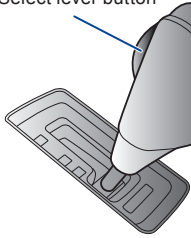

#### **M = Manual mode:**

With the vehicle either moving or stationary, move the select lever from the **D** position to the **M** position to select the manual mode.

#### **Shift paddle:**

Gearshifts can be performed using the shift paddle behind the steering wheel.

### Manual transmission (if equipped)

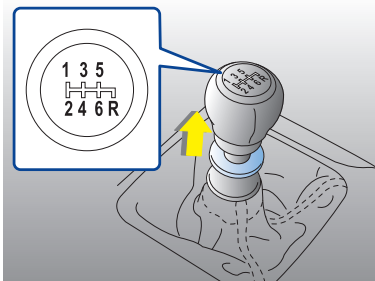

You must raise the slider and hold it in that position before you can move the shift lever to the **R** position. To change gears, fully depress the clutch pedal, move the shift lever, and gradually let up on the clutch pedal.

# DRIVER'S AREA

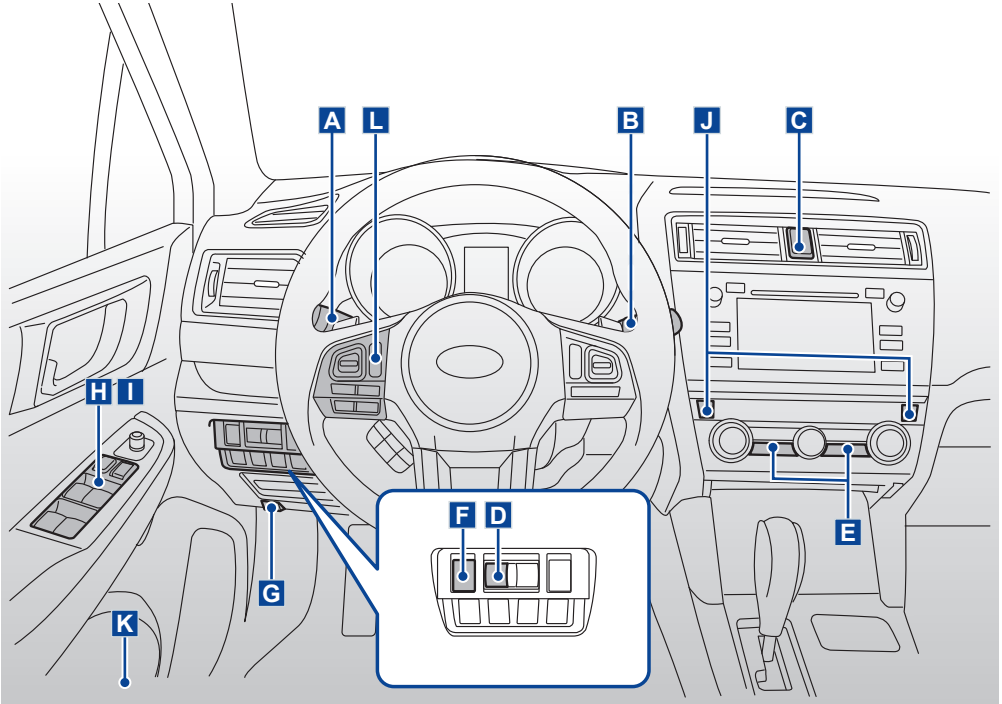

## A Headlight switch/ Turn signal lever/ Front fog light switch (if equipped)

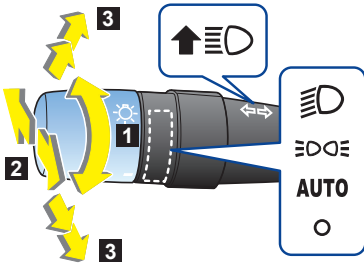

- 1** Headlights
- 2** Headlight flasher, High/Low beam change
- 3** Turn signal

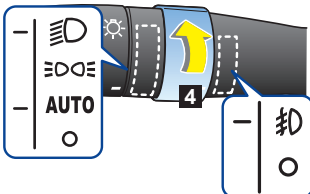

### 4 Front fog lights (if equipped)

To turn on the front fog lights, rotate dial to ☷ .

Front fog lights operate only when headlight switch is in:

- ☷ position.
- **AUTO** position and the headlights are on.

## B Wiper and washer switch

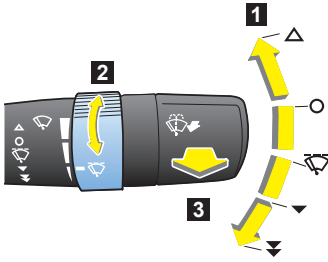

### 1 Windshield wiper

To operate the wiper, rotate knob to;

- △ : Mist (for a single wipe)
- : Off
- ⏏ : Intermittent
- ▼ : Low speed
- ▼▼ : High speed

### 2 Wiper intermittent time control

### 3 Windshield washer

## C Hazard warning flasher switch

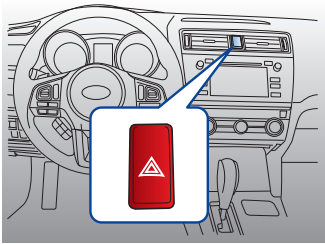

To turn on, press the button.  
Use in emergency conditions.

## D Illumination brightness control dial

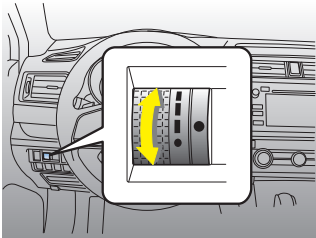

Turn the dial to adjust the illumination brightness of the instrument panel.

When the control dial is turned fully upward to

- position, the illumination brightness becomes the maximum and the automatic dimming function does not work at all.

\*The design may be slightly different from the illustration depending on the models.

## E Defroster button/ Rear window defogger button

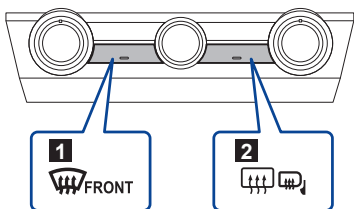

\*The illustration of the print is Type A.

**1 Defroster button:**  
Press the button to defrost the windshield.

**2 Rear window defogger button:**  
Press the button to turn on rear window defogger, outside mirror defogger or windshield wiper deicer (if equipped). The function will automatically shut off after approximately 15 minutes.

## F Trunk lid opener switch

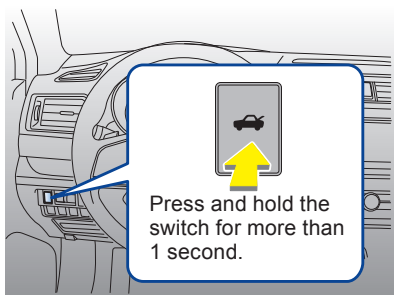

## G Hood release knob

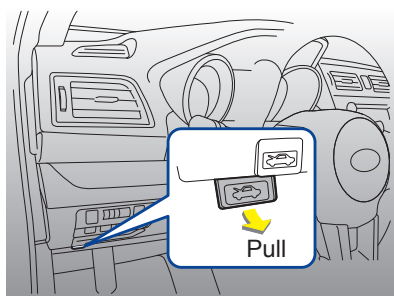

## H Power window switches

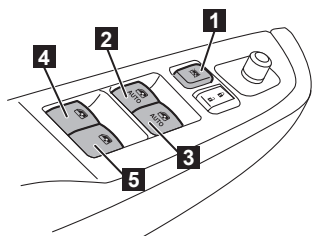

- 1 Lock switch**
- 2 For driver's window**
- 3 For front passenger's window**
- 4 For rear left passenger's window**
- 5 For rear right passenger's window**



## I Power door locking switch

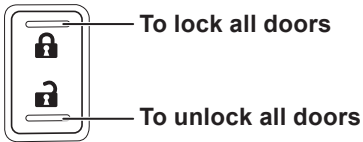

## J Seat heater

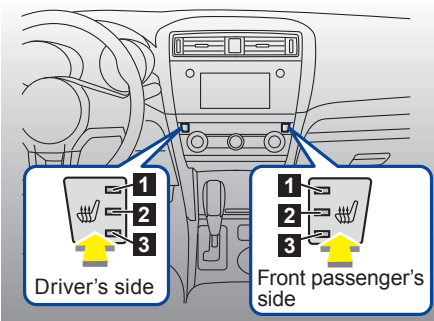

### Front seat heater switch

- 1 HIGH mode indicator
- 2 MID mode indicator (front seat only)
- 3 LOW mode indicator

## K Fuel filler lid release lever

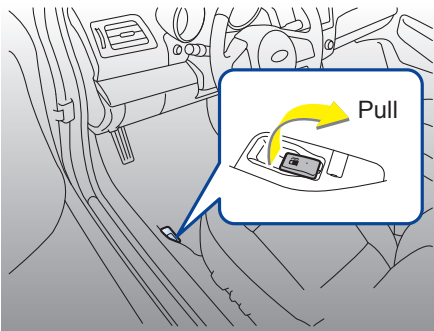

This indicates that the fuel filler door (lid) is located on the right side of the vehicle.

## L Audio control buttons

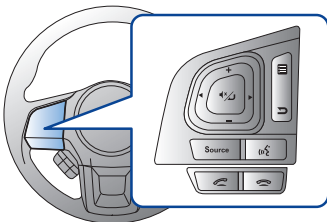

These buttons allow the driver to control audio functions without taking his/ her hands off the steering wheel.

## Hill Holder switch

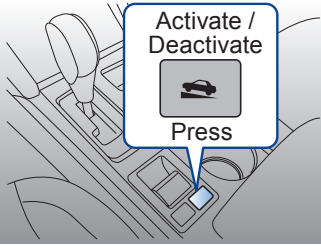

\*The design may be slightly different from the illustration depending on the models.

### Deactivate the Hill Holder function when:

- Towing a trailer
- Carrying a heavy load
- Parking brake is not used frequently when stopping on an uphill slope.

## Moonroof switch (if equipped)

### Tilting

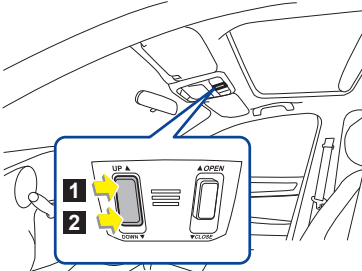

- 1 Raise
- 2 Lower

### Sliding

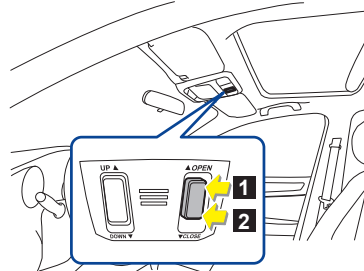

- 1 Open
- 2 Close

## Child safety locks

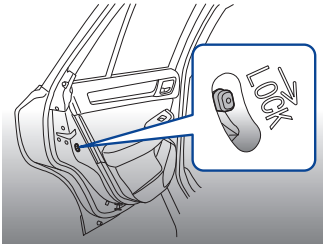

Located on the edge of each rear door.

When the lever is in the **LOCK** position, the rear door cannot be opened from the inside.

## Front seat shoulder belt anchor height

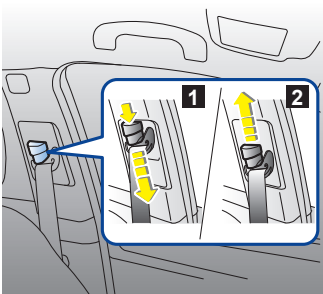

- 1 **To lower:**  
Push the upper part of the anchor and slide it down.
- 2 **To raise:**  
Slide the anchor up.

# VEHICLE PERFORMANCE FUNCTIONS

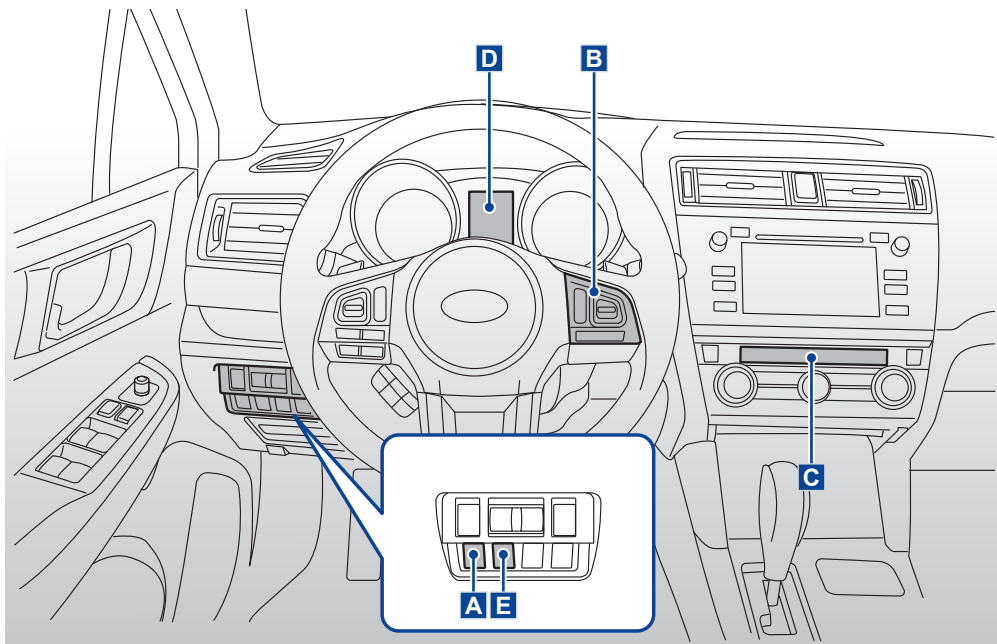

## A Vehicle Dynamics Control OFF switch

Indicator lights on the combination meter



Vehicle Dynamics Control mode



Vehicle Dynamics Control OFF mode

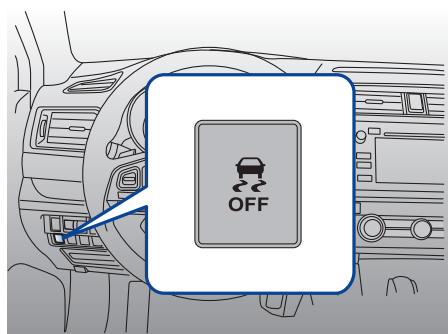

Deactivating the Vehicle Dynamics Control system facilitates the following operations.

- a standing start on a steeply sloping road with a snowy, gravel-covered, or otherwise slippery surface
- extrication of the vehicle when its wheels are stuck in mud or deep snow

Do not deactivate the system except when absolutely necessary.

## B Cruise control buttons

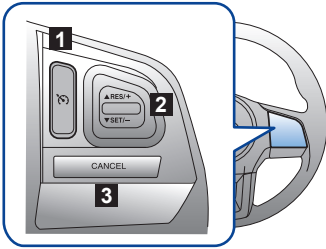

Cruise control enables you to maintain a constant vehicle speed without holding your foot on the accelerator pedal and it is operative when the vehicle speed is 40 km/h or more.

- 1 Cruise control main button:** To activate and deactivate
- 2 RES/ SET switch**
  - ▲RES/+ side: To increase the speed/ To resume
  - ▼SET/- side: To set speed/ To decrease the speed
- 3 CANCEL button:** To temporarily cancel

## C Information display

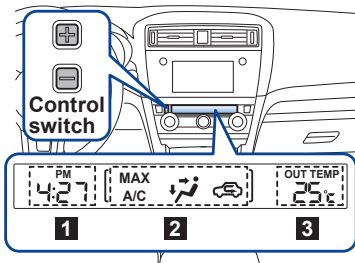

- 1 Clock**
- 2 Climate control mode indicators**
- 3 Outside temperature indicator**

**Control switch:** To adjust the time shown by the clock, press the + button or the - button.

## D Multi information display

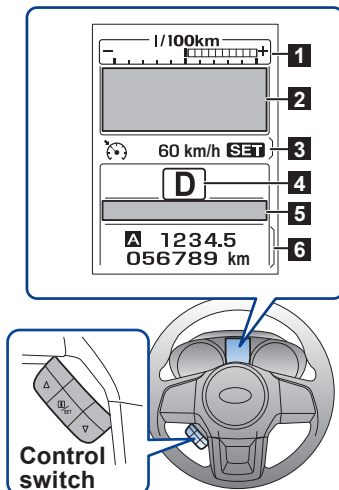

- 1 ECO gauge**
- 2 Basic screen**
- 3 Cruise control information**
- 4 Select lever/ gear position indicator**
- 5 Warning screen**
- 6 Odometer/ double trip meter**

**Control switch:** By operating ▲ or ▼ of the control switch, the screens and selection items can be switched. When the **i/SET** switch is pulled toward you, the item can be selected and set.

## **E** SRVD OFF switch (if equipped)

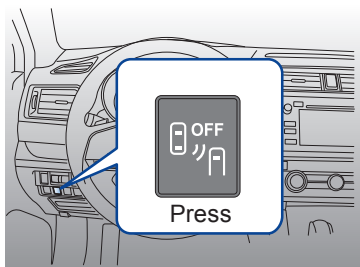

If the SRVD OFF switch is pressed, the SRVD OFF indicator is displayed on the multi information display of the combination meter, and the SRVD is deactivated.

### **SUBARU Rear Vehicle Detection (SRVD)**

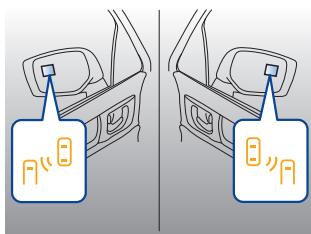

The SUBARU Rear Vehicle Detection (SRVD) consists of rear radar with Blind Spot Detection, Lane Change Assist and Rear Cross Traffic Alert.

The system notifies the driver when vehicles in the blind area are approaching from behind in the neighboring lanes.

# MAIN WARNING AND INDICATOR LIGHTS

Some warning/ indicator lights illuminate for a few seconds in order to check themselves when the ignition switch is turned ON.

## Warning lights

Refer to your Owner's Manual for countermeasures when each warning light comes on. If necessary, consult your authorized SUBARU dealer.

### Seatbelt warning



Remind the driver to fasten seatbelt.

### Front passenger's seatbelt warning



Remind the front passenger to fasten seatbelt. Location: next to overhead console.

### CHECK ENGINE warning/ Malfunction indicator



Engine/ Emission control system malfunction.

### Charge warning

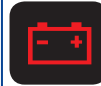

Charging system malfunction.

### Oil pressure warning



The engine oil pressure is too low.

### Engine low oil level warning



The engine oil level decreases to the lower limit.

### All-wheel drive warning (CVT models)



Tires of different diameter fitted/ air pressure excessively low.

### SRS airbag system warning



SRS airbag system and/ or seatbelt pretensioners malfunction. Front seatbelts only.

### Power steering warning



The electric power steering system malfunction.

### AT OIL TEMP warning (CVT models)



Transmission fluid temperature is too hot./ Transmission control system malfunction.

### Automatic headlight beam leveler warning (if equipped)



Automatic headlight beam leveler malfunction.

### Brake system warning



Parking brake on/ Low fluid level/ EBD System malfunction (Anti-lock brake system warning light illuminates simultaneously)/ Electronic parking brake system malfunction.

### Low fuel warning



Fuel tank is nearly empty. Refill fuel immediately.

### Access key warning (if equipped)



The access key is not inside the vehicle. For other situations, refer to your Owner's Manual.

### Windshield washer fluid warning



The fluid level in the windshield washer fluid tank decreases to the lower limit.

### SUBARU Rear Vehicle Detection warning (if equipped)



SUBARU Rear Vehicle Detection (SRVD) malfunction.

### ABS warning



Anti-lock Brake System malfunction/ EBD System malfunction (Brake System warning light illuminates simultaneously).

### Vehicle Dynamics Control warning/ Vehicle Dynamics Control operation indicator



**Warning** : Vehicle Dynamics Control system malfunction.

**Indicator** : Flashes during activation of the skid suppression function and the traction control function.

## Indicator lights

The following indicators show the current status of your car. Refer to your Owner's Manual for more information.



**Turn signal indicator**



**Headlight indicator**



**High beam indicator**



**Front fog light indicator (if equipped)**



**Security indicator**



**Vehicle Dynamics Control OFF indicator**



**Front passenger's frontal airbag OFF/ON indicator**



**Cruise control indicator**



**Cruise control set indicator**



**Door open indicator**



**Hill Holder indicator**



**Hill descent control indicator (if equipped)**



**Steering responsive fog lights OFF indicator (if equipped)**

subaru.ca

All illustrations, specifications, features and photographs contained in this brochure are based on product information available at the time of its printing, and may not be completely accurate following its publication. Colours shown may vary due to reproduction variations in the printing process, and some vehicle parts cannot be shown in certain photographs. Subaru Canada, Inc. reserves the right to discontinue or make changes at any time, without notice or incurring obligations, to colours, materials, equipment, accessories, features, specifications and models, or to change their prices. Please visit our Web site for the latest information and specifications. For detailed operating and safety information, please consult your Owner's Manual. For complete details on product updates, warranties or the Subaru C.A.R.E. program, please contact your Subaru dealer. Legacy and Subaru are registered trademarks. Printed in Canada. © 2014 Subaru Canada, Inc. 2015 model year.



**Environmental Management System (EMS)**  
**ISO 14001:2004 certified by SGS**  
[www.subaru-earth.com](http://www.subaru-earth.com)

SUBARU CANADA, INC. / FUJI HEAVY INDUSTRIES LTD.